

THE CUSTOMER-SATISFACTION EXPERTS SINCE 1921



NOBODY COMPARES!

1993 CATALOG

RadioShackCatalogs.com

INDEX PAGE 170

Welcome to Radio Shack, America's Technology StoreSM



Technology has been our business for 72 years. And now more than ever, Radio Shack is the place to shop for the latest—and best—in quality electronics.

Nowhere else will you find over 15,000 exclusive electronic products, all preselected for ease of use and value. We have the largest selection of telephones and accessories, tape recorders, calculators, radios, communications equipment, batteries and electronic accessories available.

Because Radio Shack is part of the \$4.6-billion Tandy Corporation, we have the research, development and manufacturing expertise to bring exciting new technologies to life. Radio Shack will always offer the very latest technology ... affordably.

Only Radio Shack offers sales, support and service through nearly 7000 locations. In this "self service" age, it's also good to know that we still believe in friendly, personal service. Our sales team receives up-to-date training in electronics to help you make smarter buying decisions.

Come discover why 50-million customers shop Radio Shack each year. For the best selection, the latest technology and unsurpassed convenience, we are truly America's Technology Store.

John V. Roach
Chairman of the Board and
Chief Executive Officer
Tandy Corporation

RADIO SHACK IS CREATING NEW STANDARDS Our Determination to Put You First is Driven by...

CONTINUING INNOVATION—We're creating new standards in digital audio recording and multimedia computing technology.

PROVEN LEADERSHIP—Nearly 7000 store locations, 39,000 USA employees, seven research and development centers, 31 USA and overseas manufacturing plants.

RELIABLE QUALITY—More than 1500 engineers and technicians develop, evaluate and test to our exacting standards.

ELECTRONICS SPECIALIZATION—From our high-technology personal computers to our long-life batteries, we are and have been America's electronics specialist since 1921.

EXPERIENCED SALES TEAM—Knowledgeable and friendly to make you feel at home.

PROMPT SERVICE—We have nearly 7000 drop-off points nationwide and over one million parts stocked for dependable service.

PRODUCT EXCLUSIVITY—Over 15,000 top-quality electronics products means that we have something for everyone.

GUARANTEED SATISFACTION—Putting you first has made us first in consumer electronics retailing...

NOBODY COMPARES!

Complete Index	170
Employment Opportunities	171
Special-Order (CMC)	125
Quantity Prices	171
Tandy Service Plan	171

Antennas, TV/FM	98, 104
Auto Sound	64
Batteries	89
Books	97
Cables, Audio	105
Calculators	145
Camcorders	54
Cartridges, Phono	63
Cassette Decks	46
Cellular Phones	16
Chemicals	131
Citizens Band	24
Clock Radios	32
Clocks	141
Compact Disc Players	44
Computer Equipment	150
Copier	143
Data Organizers	148
Electrical Devices	87
Electronic Parts	112
Fax Machines	144
Flashlights	93
Headphones	50
Health Care	139
Intercoms	18
Joysticks	134, 156
Keyboards, Musical	138
Kits	136
Laser Video Disc/CD Player	53
Lights, Party	138
Marine Radios	29
Metal Detectors	137
Microphones	76
Music Systems	40
PA Equipment	72
Pagers	17
Personal Stereo	34
Power Adapters & Converters	37, 94
Radar Detectors	70
Radio-Controlled Toys	135
Radios	30
Remote Controls, Audio/Video	57
Remote-Control Devices, Electrical	82
Satellite TV	56
Scanner Radios	19
Security	71, 78
Shortwave	30
Smoke Alarms	79, 81
Soldering Equipment	130
Speaker Systems	47
Speakers, Replacement	69, 108
Spelling Checkers	142
Stereo Components	42
Tape and Accessories	60
Tape Recorders	33, 36
Telephone Equipment	3
Test Equipment	126
Timers	82, 84, 140
Tools	128
Toys and Games	133
Turntables	43
TV Sets and Monitors	55
TV/Video Accessories	58
VCRs	52
Walkie-Talkies	24, 137
Watches	140
Weatheradio [®] Receivers	33
Wire and Cable	110

Prices shown are cash prices and subject to change without notice. Prices apply to participating stores in the USA, except Alaska and Hawaii, but may vary from store to store.

Trademark Notice: Marks in this catalog followed by ®, ™, or ™ are owned or used by, and identify products manufactured by or for, Tandy Corp. Other brand names identify products manufactured by or for vendors whose marks appear on the products or product packaging. Absence of a ® in connection with marks of vendors does not indicate an absence of registration of those marks. Memorex is a registered trademark of Memorex Corporation licensed to Tandy Corp.

We are America's Telephone CompanySM ...and with good reason

- **QUALITY**—all our phones are tested 40 different ways to assure high reliability
- **VARIETY**—choose from a wide array of styles and colors—over 60 models in all
- **"GOLD-STANDARD"**—50-micron gold-plated contacts on all "plug-in" equipment
- **SUPER-CCT CIRCUITRY**—for exceptionally clear sound on cordless phones
- **SATISFACTION GUARANTEED**—full one-year limited warranty, with extended Tandy Service Plans available
- **CONVENIENCE**—we carry a complete line of accessories, and have nearly 7000 locations



New! Voice-Scrambling Cordless Telephone

DUOFONE ET-499. Cordless phones are great. But since they transmit over the airwaves, your private conversations could be monitored. Now you can enjoy cordless convenience with voice scrambling for *added* privacy protection—frequency inversion technology makes transmissions between the handset and base unintelligible. Select any of ten channels for best range and reception. And Super CCT circuitry approaches corded-phone voice clarity. Amplifier volume control, base-to-handset paging, 30-memory speed-dialing, auto-set security code and mute button for private in-room comments. Desk/wall. Tone/pulse dialing. (TSP) **43-565 159.95**

Available Oct. 30, 1992

The clear choice in cordless phones! DUOFONE

DUOFONE® cordless phones are built to excel. Each must pass our tough quality-control tests, including temperature extremes, drop survival and "real world" testing. All are backed by our Satisfaction Guarantee.

F.Y.I.

ADVANCED SUPER CCT CIRCUITRY. Provides the best-available transmission clarity while greatly decreasing background noise and increasing effective communication range.

COM-LOK® SECURITY SYSTEM and AUTO-LOAD SECURITY CODE. Prevent unauthorized calling through your telephone line, by other cordless users.

PAGING SYSTEM. Lets you signal the handset from the base so that you can page someone using the handset or locate the handset if you misplace it.

FLASH. For use with services like Call Waiting.

LOW-BATTERY LED INDICATOR. Shows when it is time to recharge the battery inside the handset.

Our Finest! Super CCT, Speakerphone and Intercom

DUOFONE ET-495. The ultimate! Provides the best-available sound quality and the latest features! Make or take calls using handset or the built-in speakerphone, and talk between the two using the intercom. Separate two-way paging "beeps" handset or base from the other location. All 10 cordless phone channels are built-in—just touch a button to select best reception, even during a call. Flash, 30-memory speed-dialing, hold, touch-redial. COM-LOK and 640,000-combination security code. (TSP) 43-567 159.95



Space-Saver With Super CCT

NEW! DUOFONE ET-440. The handset stands upright in the compact charger base, taking up less space on your desk or countertop. Flexible handset antenna resists breakage. You get 256-combination security code, base-to-handset paging, touch-redial, flash for services like Call Waiting, and privacy button. Has 30 speed-dial memories, including three one-touch memories for priority numbers. (TSP) 43-564 . . 119.95



Super CCT and 30 Memories

DUOFONE ET-490. Enjoy the convenience of cordless with corded-phone sound quality. Super CCT system and 10-channel operation for extra clear reception and transmission. Just touch a button to choose the clearest channel. Receiver volume control lets you adjust volume to a personalized level. Page key on base "beeps" handset. Has 30-memory speed-dialing, flash, privacy button and touch-redial. Auto-load and COM-LOK security system. Ringer hi/lo/off. (TSP) 43-566 139.95



DU6FONE ET-470. Features advanced Super CCT system, plus three instant-dial priority memories that are ideal for your frequently called or emergency numbers. COM-LOK security system and auto-set 64,000-combination security code help ensure that others can't use your line. Has touch-redial, flash and privacy button for private in-room comments. (TSP) 43-571 99.95

NEW! DU6FONE ET-472. Packed with the most convenient features! Two lines and 30-memory speed-dialing. Super CCT and 10-channels for the clearest reception and transmission. 640,000-combination security code. Conference button allows three-way conversations. Touch-redial. LED line-status indicators show which line is ringing, on hold or in use. Privacy button. (TSP) 43-561, 149.95



Available
Oct. 30, 1992



DU6FONE ET-475. Features include Super CCT and speed-dialing of 27 numbers, plus three instant-dial priority numbers. COM-LOK and 64,000-combination security code. Flash button for services like Call Waiting and office PABX. Touch-redial, privacy keys. Base has LED charging and handset in-use indicators. (TSP) 43-572 119.95



DU6FONE ET-394. Even our budget-priced cordless phone is sure to please. Gives you convenient base-to-handset paging and one-touch redial of last number called. Auto-load and COM-LOK security codes protect your line from unauthorized use. Has LED charging and low-battery indicators. (TSP) 43-554 69.95

	ET-495	ET-470	ET-490	ET-440	ET-472	ET-475	ET-394	ET-499
Super CCT Circuitry	✓	✓	✓	✓	✓	✓		✓
COM-LOK Security	✓	✓	✓	✓	✓	✓	✓	Scrambled
10-Channel Operation	✓		✓		✓			✓
Paging System	✓		✓	✓	✓		✓	✓
Low-Battery Indicator	✓	✓	✓	✓	✓	✓	✓	✓
Redial	✓	✓	✓	✓	✓	✓	✓	✓
Flash	✓	✓	✓	✓	✓	✓	✓	✓
Privacy	✓	✓	✓	✓	✓	✓		✓
Memories	30	3	30	30	30	30		30
Speakerphone	✓							
Ringer Volume Control	✓		✓		✓			✓
Handset Volume Control	✓		✓		✓			✓



Carrying Case. Hooks on a belt loop so you can keep your phone at your side. Protects and provides hands-free carrying for most cordless handsets. Soft black vinyl. 43-190 5.49

Flexible Antenna. Replaces inconvenient, bent or broken telescoping antennas on most cordless handsets. No need to remove your existing antenna. 43-189 5.49

How to stay in touch even when you're out



Available Oct. 30, 1992

Dual Microcassettes and Phone

NEW! DUOFONE TAD-271. Time/day/date voice stamp tells you when a call was received. Remote operation. Selectable 30-sec./3-min. message length. Features 2-way recording, call monitor and room monitor. Built-in tone/pulse phone has a 20-number memory, redial, flash. 3³/₈ × 6³/₈ × 9¹/₄". (TSP) **43-707** **129.95**



Available Oct. 15, 1992

Voice Mail — Leave Special Messages for Friends

NEW! DUOFONE TAD-346. Record a standard outgoing message plus an alternate message only friends and family can hear by using a special code. Tell friends you'll be away from home without telling strangers. Dual microcassettes make changing messages simple. Voice stamp tells you when each call was received. Selectable 30-second/3-minute incoming message length. Beeperless remote operation, 2-way and memo recording. Room and call monitor, Toll-saver. 2 × 6¹/₂ × 5¹/₂". (TSP) **43-703** **99.95**



Voice Mail Answerer

DUOFONE TAD-345. Record two announcements—a standard message and a personal message only friends and family can hear by using a special code. Voice actuation. Memo and 2-way recording. Remote operation, Toll-saver. Room and call monitors. 2 × 7⁵/₈ × 5³/₈". (TSP) **43-700** **79.95**



Microcassette Answerer

NEW! DUOFONE TAD-246. Records your outgoing message in its built-in digital memory. Automatic Toll-saver, remote operation, call screening and memo recording. Outgoing announcement backup. VOX recording. 2¹/₈ × 7¹/₄ × 5³/₈". (TSP) **43-755** **59.95**



Microcassette Answerer/Phone

NEW! DUOFONE TAD-274. Outgoing message is recorded on a computer chip. Time/day voice stamp on each incoming call. Voice-actuated recording saves tape. Two-way and memo recording, call monitor. Tone/pulse phone has 20-number memory, redial, hold, flash. 4 × 6⁵/₈ × 8⁷/₈". (TSP) **43-760** **119.95**

Answering System With Phone

NEW! DUOFONE TAD-248. Microcassette answerer stores the outgoing message on a computer chip—no need for two tapes. Remote operation and call monitor feature. Voice-actuated recording saves tape space. Built-in tone/pulse phone has 20-number memory, flash and redial. 3¹/₂ × 5¹/₄ × 9". (TSP) **43-757** . . **99.95**

Available Sept. 30, 1992



Answering America's CallsSM

DUōFONE

With busy schedules so common today, it's important that friends and family be able to leave messages for you when you're not in. With DUōFONE, you'll get those messages clearly every time.

Time/Date Stamp

DUōFONE TAD-440. Voice "stamps" time, day and date on each incoming message. Announces number of calls and messages left. Auto-reset, Toll-saver. Memo and 2-way recording. Room and call monitor. Remote turn-on. Requires 9V battery. 2¹/₄ × 9 × 7³/₄". Was \$119.95 in 1992 Cat. (TSP) **43-400, New Low Price! 99.95**



Timer-Activated

DUōFONE TAD-450. Automatically turns on/off at preset times. Time/day/date voice stamp. Remote operation, multifunction LCD display, dual cassettes, and toll-saver. Memo and two-way recording. Auto-reset stops the answerer if you pick up telephone. 2¹/₈ × 9¹/₈ × 8³/₈". Was \$139.95 in 1992 Cat. (TSP) **43-720, New Low Price! 119.95**



Microprocessor Controlled

DUōFONE TAD-412. Soft-touch controls handle functions smoothly. Remote operation, voice actuation, dual cassettes, Toll-saver. 2¹/₄ × 9 × 7³/₄". (TSP) **43-399 79.95**

LED Message Counter

DUōFONE TAD-425. Features remote operation, voice actuation, call monitor. Dual cassettes, Toll-saver, memo and 2-way recording. LCD displays number of messages. Answerer stops automatically when you pick up the phone. Memory requires 9V battery. 2¹/₈ × 9¹/₄ × 8³/₈". (TSP) **43-711 99.95**



Two-Line Answerer

DUōFONE TAD-430. Can answer two lines at the same time. The first caller is greeted by your recorded announcement, the second by a built-in announcement. Features dual cassettes, Toll-saver, call monitor, auto-reset. Selectable security code and remote turn-on. 2 × 9¹/₄ × 8¹/₂". (TSP) **43-712 119.95**



Dual-Cassette Answerer

DUōFONE TAD-410. Microprocessor controlled. Voice actuation, remote turn-on. Auto-reset stops announcement when you pick up phone. 2¹/₄ × 9 × 7³/₄". (TSP) **43-398 69.95**

DUōFONE gives and takes your messages clearly every time

DUōFONE answerers deliver standard features plus "extras" other ordinary brands don't give you. Tape jam and break sensor keep your phone line free by turning off the answerer if a tape ever malfunctions. Power-interrupt protection preserves messages and operational mode during brief power failures—the answerer automatically returns to last setting when power is restored. Answerers with two-way recording let you record both sides of a conversation. Built-in electrical spike protection exceeds FCC requirements, and every DUōFONE is FCC registered and certified to meet all applicable UL standards.

Many models feature dual cassettes to make it easy to change announcements and store received messages. All remote operation answerers have Toll-saver to indicate if there are any new messages—this saves you money on possible long-distance charges. Leave messages for yourself or others in the home with the memo recording feature found on many models—works like an electronic bulletin board. Call monitor lets you hear who is calling before deciding to pick up the phone. Models with room monitor allow the user to monitor sound in a room from another room or remote location. DUōFONE is the clear choice!

Phones that look and sound great



Clear-Fone™

See what you've been missing! Lights up when it rings (no extra wiring needed). Lighted dial, touch-redial, ringer on/off. Desk or wall.

43-371 39.95



Clear Mini-Fone

One-piece-style phone lights up when it rings. It's a real conversation piece! Ringer on/off switch. For desk or wall.

43-817 17.95



Clear-Fone II

NEW! Classic black and chrome accents add a distinctive touch. Lights up when it rings. Ringer on/off switch, one-touch redial. Desk or wall.

43-820 ... 39.95

Smart Talk — Stylish Desk Phones

(1) **Diana™ Phone.** Tasteful, understated granite design adds a modern feel to your surroundings. All the most wanted features including flash button for services like Call Waiting, hold with LED indicator, last-number redial and ringer hi/lo/off volume control. 43-384 ... 34.95

(2) **Fiesta™ Phone.** Pastel-colored buttons and modern styling make this phone a bright addition to any room. Hold button with LED reminder and last-number redial. Flash button, hi/lo/off ringer control. 43-819 ... 39.95

(3) **NEW! Wedge™ Phone.** Eye-catching shape plus lime-green color with jet black accents. Ringer hi/lo/off control and last-number redial. 43-824 29.95

(4) **Midnight™ Phone.** Elegant midnight black phone is both classic and contemporary so it looks good with any decor. Hold button with LED, flash button, last-number redial. Ringer hi/lo/off. 43-815 44.95

(5) **Ruby™ Phone.** Bright color and bold styling in one compact phone. Loaded with features—hold with LED, last-number redial, ringer on/off switch. 43-816, 37.95



Krystalite™ Neon

Elegant design adds the cool glow of pink or blue neon to any decor. Light flashes when phone rings. Adjustable—set the mood by controlling the brightness or turn it off completely. Includes hold button with LED, one-touch last-number redial, ringer on/off switch. Pink, 43-809. Blue, 43-810 Each 59.95



Neon Clear-Fone

NEW! Combines fun see-through design and the colorful flash of neon. Bright neon light flashes when phone rings. Has lighted dial, one-touch redial of last number called, ringer and neon light on/off controls. Desk or wall. Pink, 43-825. Blue, 43-826 .. Each 49.95



Available Oct. 15, 1992.



Phones That Know Fashion

(1) **NEW! Krystal™ III Phone.** A beautiful desk phone that's simple in its elegance. Features hold button with LED indicator, one-touch redial of last number called. Flash button for use with special services like Call Waiting. Ringer on/off control. 43-821 39.95

(2) **Tudor™ Phone.** Great looks combined with practical features and low-profile design. Has flash button for use with special services, LED ring indicator and one-touch, last-number redial. Hi/lo ringer volume switch. 43-818 ... 27.95

(3) **Radio Shack ET-205.** Big buttons and bold style complement any decor. Flash button, one-touch redial, hold button with LED indicator, ringer hi/lo control. Desk or wall. 43-802 39.95



Available Oct. 15, 1992.

SWITCHABLE and PROGRAMMABLE Touch-Tone/pulse phones work on both tone and pulse lines. Therefore, in areas having only pulse (rotary dial) lines, you can still use services requiring tones, such as alternative long-distance systems and computerized services. Not for coin or party lines. We service what we sell.



Big-Button Telephone

NEW! Radio Shack ET-206. Ideal for homes with small children or older adults. Features one-touch dialing of three priority numbers, plus additional 10 number memory. Amplified handset for noisy areas or for the hearing impaired. Last-number redial, hold button with LED indicator, ringer volume control. Desk or wall. 43-804 49.95

Phones to fit your style and budget

Radio Shack offers a wide variety of phones, many with special convenience features. Easy to use, they're ready to plug in with standard modular connectors and include illustrated instructions. All are hearing-aid compatible. All are backed by a full one-year limited warranty, with extended Tandy Service Plans available. Best of all, service and a complete line of accessories are available, through nearly 7000 Radio Shack stores and dealers in the USA—we're near you!

Amplified Big-Button Extra-Feature Phone

Radio Shack ET-203. A modern design with big, easy-to-see and dial buttons. Amplified headset with volume control to adjust sound to a level that's comfortable for you. Hold button with LED indicator, handy one-touch redial and hi/lo/off ringer control. Mount on wall or set on desk or table.

43-338 44.95



Little Phones That Perform BIG on Desk or Wall

(1) **ET-272 Slim-Fone®.** Dependability and trim styling on a budget. This phone gives you the convenience of touch-redial and hi/lo/off ringer control. Long 14-foot cord. **Almond, 43-539. White, 43-540** Each 24.95

(2) **ET-126 Mini-Fone™.** Compact one-piece design lets you "hang-up" on any flat surface. Great for desk, bedside table or wall. Has touch-redial and ringer hi/lo/off volume control. 43-500 19.95

(3) **ET-282 Slim-Fone.** Simply the ultimate in convenience and practicality. Speed-dials 20 frequently called numbers. Redial with pause. Hi/lo/off ringer control. **White, 43-542. Almond, 43-548** Each 29.95

(4) **ET-292 Trim-Fone®.** Speed-dials up to 20 numbers. Easy-to-see lighted keypad. Last-number redial with pause. Bell on/off switch. Were \$44.95 in 1992 Catalog. **White, 43-581. Almond, 43-582** New Low Price! Each 39.95

(5) **NEW! ET-501 Trim-Fone.** Features a lighted keypad and amplified handset with adjustable volume. One-touch redial of last number called. 43-805, 39.95



Feature Phones for the Office or Home

(1) **Radio Shack ET-174.** Easy-to-hold "K" style handset, oversize buttons with large, easy-to-see numbers. Adjustable handset volume control. One-touch redial and on/off ringer control. 43-578 49.95

(2) **Radio Shack ET-171.** This attractive desk phone has hold button LED reminder, handy one-touch redial of last number called and hi/lo/off ringer control. **Beige, 43-375. Black, 43-377. White, 43-374** Each 39.95

(3) **Mini Wall-Fone.** Conveniently mounts on wall wherever you need an extension phone. Features hold button with LED reminder. Handy one-touch redial and hi/lo/off ringer control. 43-337 39.95

(4) **Radio Shack ET-143.** 20-number speed-dialing with personal directory. Hold button with LED indicator, flash button, redial. Desk or wall. 43-596 .. 49.95

(5) **ET-290 Trim-Fone.** Lighted keypad, touch-redial and on/off ringer control. Desk or wall. Were \$34.95 in 1992 Catalog. **White, 43-585. Almond, 43-586. Gray, 43-587** New Low Price! Each 29.95

Make Radio Shack Your Telephone Company®

Whether for business or personal use, your phone is vitally important. That's why all of our telephones are designed, built and tested to assure reliability. Unlike so many other brands, our extra-feature phones maintain basic operation even if external power fails—you won't be out of touch. All models are FCC registered. And our quality-control programs, including drop tests and temperature extremes, mean you can expect years of trouble-free operation.

Know who's calling before you answer

Now, with **Caller ID Service** from your phone company and a Caller ID device, you can actually see the phone number and/or name of the caller before you answer. The display device will show the information for every incoming call where the information is available. If the call originates in an area where Caller ID is not yet available, your display will read "OUT OF AREA". There are many advantages to this service. For instance, you can end unnecessary interruptions when you're busy by answering only the most urgent calls.

See note at right.



Available
Oct. 30, 1992

Display shows number or name of
caller, plus date and time*

NEW! DUOFONE®-660 Speakerphone With Built-In Caller ID. The convenience and safety of Caller ID, plus lots of handy features. Caller ID info can be stored for later review. Two-way speakerphone allows on-hook dialing and lets everyone get in on the conversation. Direct access 22-number memory for dialing important numbers quickly. Built-in digital clock with timer to measure length of call—helps keep phone bills down. Last-number redial, pause, flash button for special services like Call Waiting and mute features. Hi/lo/off ringer control. Requires 4 "AA" batteries. (TSP) 43-955 . . . 119.95

*Note: Displays either the number or name of caller, depending on local ID Service—check with your phone company or Radio Shack store. Caller ID Service not yet available in all areas.



DUOFONE-203. Two-way speakerphone for hands-free calls. Alpha-numeric LCD lets you speed-dial 200 memory numbers by name, not code. Three one-touch priority buttons. Last-number redial, flash, hi/lo/off ringer control. Requires 2 "C" batteries. (TSP) 43-624 99.95



DUOFONE-188. Speakerphone lets the whole family hear. Memory stores up to 90 numbers. LCD display shows number called, time and call length. Last-number redial, privacy button, flash. Ringer hi/lo/off control. Requires 2 "C" batteries. (TSP) 43-618 . . . 79.95



DUOFONE-148. One-touch speed-dialing of 20 memory numbers. Speakerphone for hands-free use. Privacy button. Last-number redial, flash/pause feature for special services, hi/lo/off ringer control. Requires 2 "AAA" batteries. (TSP) 43-612 69.95



DUOFONE-151. Feathery-light headset with adjustable mike. Can be worn over either ear. Quick-disconnect plug lets you temporarily disconnect phone line without removing headset. Hold button with LED reminder, redial, talk/hang-up buttons. Volume control. 43-590 49.95



DUoFONE System-411. Discover the economy of owning your own 4-line business phone system with features like a built-in 2-way intercom that requires no extra wiring, Centrex/PABX compatibility and line-status LEDs.

Expands to 12 stations as your business grows. Individual line-ringer controls for each station, plus a do-not-disturb button for privacy. Flash for special services like Call Waiting. Hold button, last-number redial, aux jack for adding speaker or answerer. UL listed AC adapter. Ringer back-up requires 9V battery. (TSP)
43-456 129.95

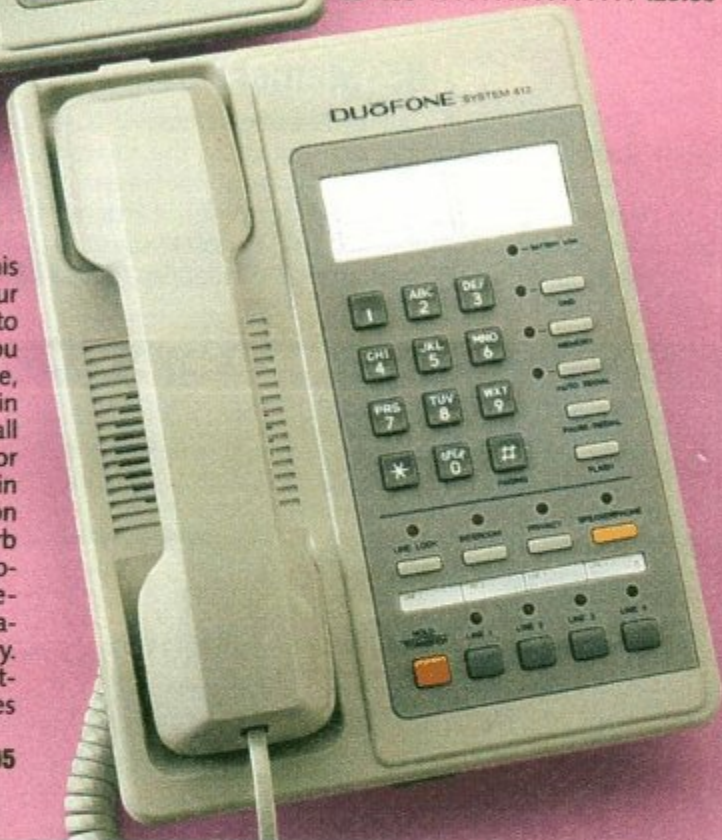

DUoFONE System-412. This system handles up to four phone lines and expands to 10 stations. LEDs tell you which lines are free, in use, ringing, or on hold. Built-in two-way intercom can call an individual station or page—all through built-in speakers. Line-lock button for privacy. Do Not Disturb feature prevents interruptions. With individual line-ringer controls at each station. 20-number memory. Redial and auto-redial buttons. UL listed AC. Requires 9V battery. (TSP)
43-460 179.95

Multilines for busy homes and offices

F.Y.I.

LINE STATUS INDICATORS. On multiline phones, shows when a line is in use, ringing, or on hold at all stations.

INTERCOM. A feature used to talk between two stations or page through the built-in speakers.

SPEAKERPHONE. Allows hands-free two-way conversations—ideal for conference calls.

AUTO-REDIAL. Automatically continues calling a busy or unanswered number, usually up to 10 times or until the call is answered.

CONFERENCE CALLING. Allows the user of a multiline phone to call two other parties and initiate a three-way conversation.

Phone System Compatibility Chart

	43-616 Sys 208	43-617 Sys 209	43-456 Sys 411	43-460 Sys 412
Sys 208	X ✓	X ✓	X ✓	NC
Sys 209	X ✓	X ✓	X ✓	NC
Sys 411	X ✓	X ✓	X ✓	NC
Sys 412	NC	NC	NC	X ✓

X = Line Status Indicators Are Compatible

✓ = Intercom Features Are Compatible

NC = Not Compatible



DUoFONE System-208. Two lines and a built-in intercom make your employees easy to reach. Separate line-ring tones, paging and 20-number memory. Flash, status LED, hold/privacy. UL listed AC. Memory backup requires 2 "AAA" batteries. (TSP) **43-616 99.95**



DUoFONE System-209. Two lines with built-in speaker phone and built-in intercom. Conference-calling capability, paging and 20-number memory. Flash, LED line-status indicators, hold. Memory backup requires 2 "AAA" batteries. (TSP) **43-617 119.95**



Radio Shack ET-180. Traditional styling and modern features. Make calls on either of the two lines and put one or both lines on hold. Separate ring/hold LEDs for each line plus different-sounding ringers, touch-redial. Hi/lo/off ringer control. (TSP) **43-373 59.95**



ET-291 Trim-Fone®. A compact desk or wall phone with two lines. With ring and hold LED indicators for each line. Conference feature for making 3-party calls. Hi/lo/off ringer controls for each line. Redial, lighted keypad. (TSP) **43-621 59.95**



Radio Shack ET-142. This 2-line phone speed-dials 20 numbers. Put one or both lines on hold. Ring and hold LED indicators for each line. Touch-redial. Memory backup requires 2 "AAA" batteries. (TSP) **43-640 69.95**

It's easy to add special features to your phone

Talk about handy! These quality-built add ons let you get the most from your telephone at home or office. No special tools are required—modular connectors make installation "plug in" simple!

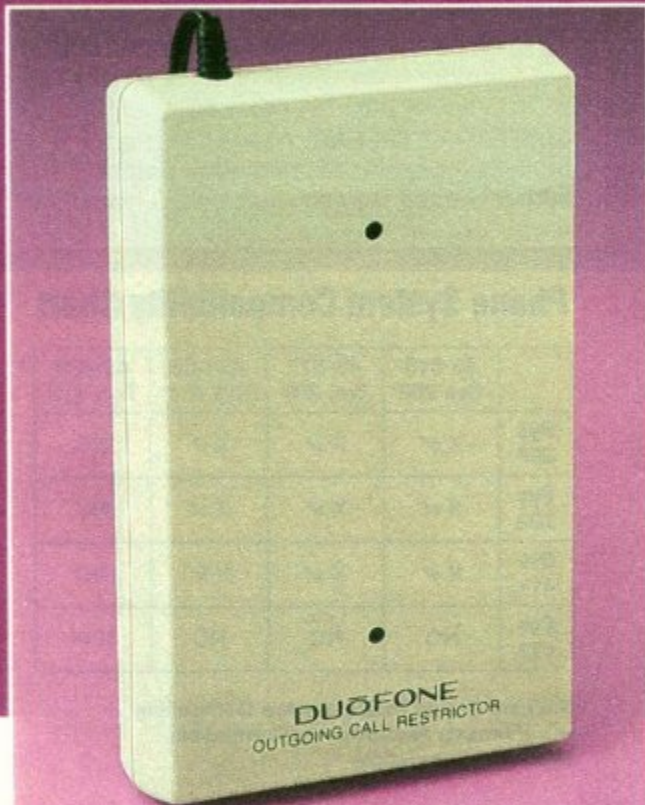

Outgoing Call Restrictor

Lets you stop unauthorized "976", "900", long distance and even local calls from being made on your line. One unit restricts all phones on the line. Personal code allows you to easily bypass call restrictions. Requires 2 9V batteries. (TSP) **43-952, 69.95**



Memory Dialer

This pocket dialer has a 33-number memory to let you access low-rate long distance and special services. Requires 3 "AAA" batteries.

43-141 24.95

Budget Dialer

Manual tone dialer is ideal for beeperless answerers plus tone-activated dictation and Ham autopatch. Requires 3 "AAA" batteries.

43-139 15.95



New! 85-Memory Caller ID System

DUOFONE. With Calling Number Delivery (CND) service from your local phone company, you can know the name and telephone number of who's calling even before you answer (where available). After the first ring, the display shows and stores name and number, call number and the date and time of each call, so you know who called while you were out. Requires 9V battery or AC adapter. (TSP) #**43-953 89.95**

See Caller ID Story on Page 10

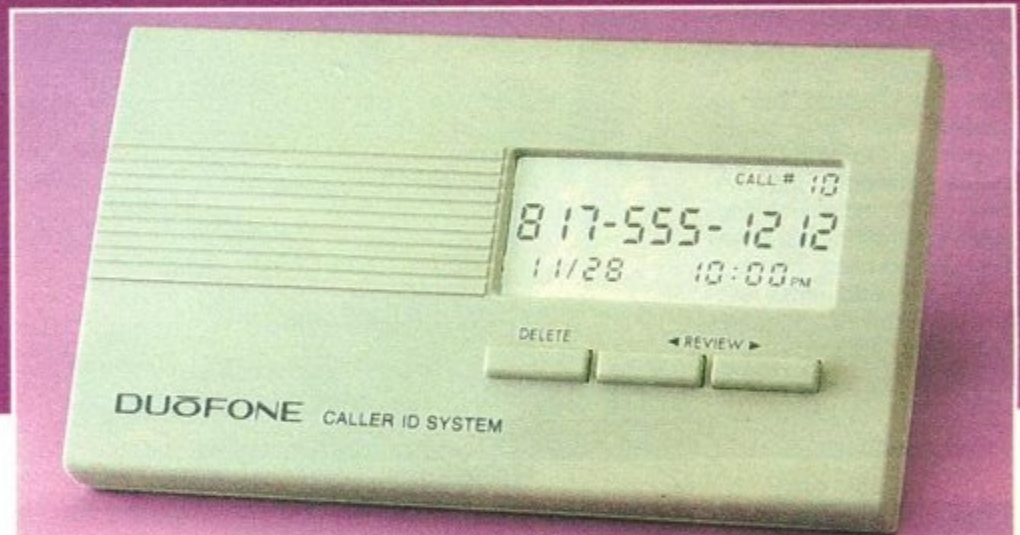

New! Calling Number ID System

DUOFONE. With the Caller ID System and Calling Number Delivery service from your local phone company, you can help eliminate nuisance phone calls and add to your family's privacy at the same time. Displays phone number, plus the date and time of each call after the first ring. Stores entries in memory so you can keep track of calls while you are away. Requires 9V battery. (TSP)

43-951 69.95.

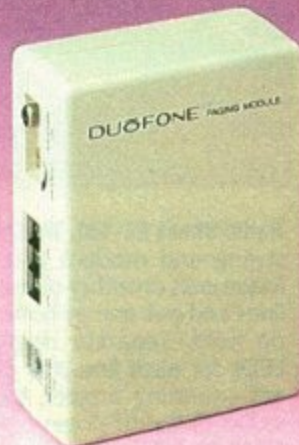

Phone Paging Module

Connects tone phone to PA system so you can page other work areas through your phone. Just connect to a PA amplifier. To page, just lift the handset and press ★. Press # to put caller on hold and page. UL listed AC adapter. **43-183 39.95**

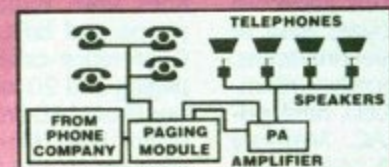



Hands-Free Universal Headset Telephone

DUOFONE-129. Ideal for anyone who needs to keep hands free during conversations. Adjustable mike boom, volume control and headset/handset switch. No need to unplug the headset to switch to handset. Requires 4 "AA" batteries. **43-172 49.95**

We're #1 in phones and accessories

We've got everything you need in telephones and accessories—including headset telephones that let you say goodbye to neck and shoulder pain caused by cradling the handset while you take notes or check files. You get relief and increased productivity at the same time! Our telephone amplifiers and speakers give you superb voice-quality so you hear it right the first time around. If you depend on your telephone then come see us—you can depend on our products and our service every time. In addition, we have more than 60 different telephones, and nearly everything in plugs, cords and adapters. We'll help you make the right choice about accessories, so you can count on the very best connections.



Hands-Free Speakerphone

DUOFONE-102. Adds convenience to any phone. High-speed talk/listen switching. Phone-line powered. **43-292 39.95**



Portable Listener

Boosts incoming voice so others nearby can hear the conversation. Requires 9V battery or AC adapter. **43-231 ... 8.95**



Handset Amplifier

Boosts the incoming sound. For phones with modular handset cord. Requires 9V battery. **43-237 19.95**



Shoulder Rest

Frees your hands. It's padded for comfort and easy to install on most handsets. Adjustable. **43-119 5.49**



Snap-On Amplifier

Boosts incoming sound. Use it at home, take it along. Works with most phones. Requires "N" battery. **43-229 ... 10.95**

Custom Outgoing Phone Answerer Tapes



■ For use with most standard answering machines

Rich Little Vol. I. Let the famous impersonator of Groucho Marx, W.C. Fields, Humphrey Bogart and others liven up your announcements. Ten different answers so callers will always be in for a surprise when they phone you. **43-419 5.95**

Professional Edition. Outgoing messages for various situations and occasions—ideal for a growing business or home office. **43-422 5.95**

NEW! Musical Madness. Memorable musical greetings like '50s pop, Rap rhyme, western song, game show fanfare, even holiday greetings. **43-423, 5.95**



Demagnetizer/Cleaner

This convenient kit keeps answerer's outgoing and incoming messages crisp and clear. Demagnetizer cassette, probe, mirror, solution. **44-1167, 5.95**



Microcassette Cleaner

Kit keeps your microcassette-type answerer operating like new for years to come. Includes cleaner, probe, mirror and solution. **44-1168 5.99**



Announcement and Message Tapes

Size	Type	Recording Time	Cat. No	Each
Cassette	Announcement, Endless Loop	15 Seconds	43-403	4.95
Cassette	Announcement, Endless Loop	20 Seconds	43-401	4.95
Cassette	Announcement, Endless Loop	30 Seconds	43-402	4.95
Cassette	Announcement, Endless Loop	60 Seconds	43-406	4.95
Cassette	Announcement, Endless Loop	3 Minutes	43-407	4.95
Cassette	Announcement, Endless Loop	20 Seconds	43-414	5.95
Cassette	Announcement, Leaderless	30 Sec./Side	43-435	2.29
Cassette	Announcement, Leaderless	90 Sec./Side	43-436	2.29
Cassette	Announcement, Leaderless	2½ Min./Side	43-437	2.29
Cassette	Announcement, Leaderless	5 Min./Side	43-439	4.39
Micro	Announcement, Message	15 Min./Side	43-412	3.59
Micro	Announcement	7½ Min./Side	43-409	3.49
Cassette	Message, Leaderless	30 Min./Side	43-410	2.39
Cassette	Message, Leaderless	45 Min./Side	43-411	2.49

Gold standard telephone accessories

Get the finest! All of Radio Shack's direct-connecting phone equipment meets FCC specifications of 50-micron gold contacts.

Modular Handset Cords

25 Feet, Standard	Cat. No.	Each
White	279-301	5.95
Almond	279-302	5.95
Beige	279-303	5.95
Brown	279-304	5.95
Gray	279-300	5.95
Black	279-305	5.95

12 Feet, Standard	Cat. No.	Each
White	279-306	4.95
Almond	279-307	4.95
Beige	279-308	4.95
Brown	279-309	4.95
Gray	279-311	4.95
Black	279-312	4.95

25 Feet, Heavy-Duty	Cat. No.	Each
White	279-290	7.95
Almond	279-291	7.95
Beige	279-292	7.95
Brown	279-293	7.95
Gray	279-294	7.95
Black	279-295	7.95

Standard Coiled



Heavy-Duty. Retains coiled shape longer

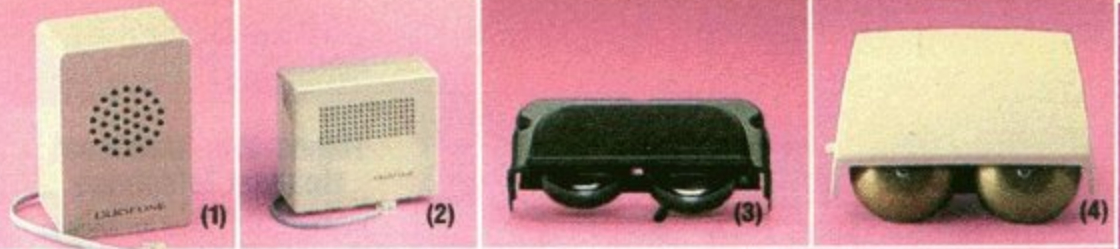

Indoor Extension Bells

(1) **Extension Bell.** Easy to install—just plug into a modular jack. Cancels phone's electronic ringer. Will also work by itself as a remote bell. **43-175 14.95**

(2) **Extra-Volume Bell.** It's really loud—the way phones used to ring. Volume control. Plugs into modular jack. **43-173 21.95**

In/Outdoor Extension Bells

(3) **Weather-Resistant.** Just the thing for a porch, patio, garage, dock or warehouse. Plugs into a modular jack. **43-174 . . . 29.95**

(4) **NEW! Chime/Ringer.** Switch-selectable chime or conventional telephone ring. Two 3" gongs in molded case. Plugs into modular jack. **43-180 Available Sept. 30, 1992 . . . 39.95**

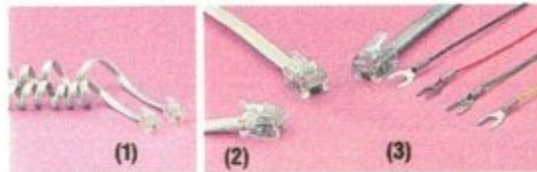

UL Listed Modular Line Cords

Fig.	Length	Description	Cat. No.	Each
1	18 Ft.	Satin, Coiled Modular-to-Modular	279-395	5.95
1	18 Ft.	White, Coiled Modular-to-Modular	279-396	5.95
1	18 Ft.	Brown, Coiled Modular-to-Modular	279-397	5.95
1	18 Ft.	Almond, Coiled Modular-to-Modular	279-398	5.95
1	18 Ft.	Gray, Coiled Modular-to-Modular	279-399	5.95
2	12 Ft.	Modular-to-Modular	279-374	4.99
2	25 Ft.	Modular-to-Modular	279-356	6.15
2	5 1/4"	Modular-to-Modular	279-390	.99
2	25 Ft.	6-Cond. Modular-to-Modular	279-422	7.95
2	25 Ft.	6-Cond. Modular-to-Modular	279-364	6.15
3	12"	Modular-to-Spade Lugs	279-391	1.99
3	12 Ft.	Modular-to-Spade Lugs	279-310	4.99

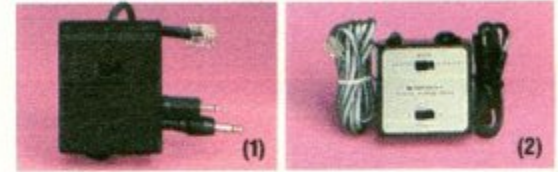

Cassette Recorder Controllers

These devices plug into a modular jack and into the mike and remote jacks of most cassette recorders. When the phone is lifted, the recorder starts automatically and tapes both sides of the conversation. The recorder stops when the phone is returned to the hook. A recorder controller is really handy for anyone who needs to keep a record of information or orders taken by phone.

(1) **For Single Phone.** **43-228 19.95**

(2) **Multiphone.** Activates recorder when any extension on the line is used. **43-236 24.95**



Now You Can See it Ring! Fone-Flashers

(1) **Fone-Flasher 2.** Activates built-in strobe light and ringer when phone rings. Selectable ring/flasher/combo modes. Plugs into modular jack. UL listed AC. **43-178 29.95**

(2) **Fone-Flasher®.** Turns a lamp on and off when phone rings. Ideal for noisy areas. Handles incandescent lamp up to 300W. Plug-in hookup. UL listed AC. **43-177 . . . 14.95**

(3) **Mini Fone-Flasher.** Ideal for offices with many phones. Shows which phone is ringing. Line-powered. **43-179, 8.95**



Extension Cords

Modular plug at one end. Two standard modular (RJ11/14) jacks at the other end.
12-Foot. 279-373 5.49
25-Foot. 279-363 6.49

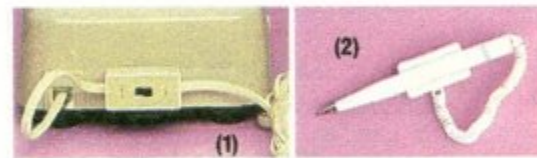

Handy Phone Silencer and Pen

(1) **Ringer Silencer.** When you don't want to be disturbed, just flip the switch and your phone's ringer is disabled, but you can still call out. Works with any phone that has a detachable modular cord. Plug-in hookup. 7-foot cord. **43-127, 7.95**

(2) **Pen With Stick-On Holder.** Attaches to phone. Keeps a pen where you need it. **43-110 . . . 99c**

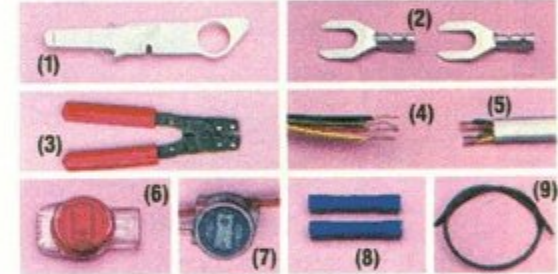

Wiring Tools and Phone Cable

Fig.	Description	Cat. No.	Price
1	Wire Stripping Tool	279-400	1.99
2	Insulation-Piercing Spade Lugs	64-3070	24/1.29
3	Phone Connector Crimping Tool	64-410	7.79
4	50-Foot, 4-Conductor Cable	278-872	6.49
..	100-Foot, 4-Conductor Cable	278-873	11.99
..	4-Conductor Bulk Cable	278-1310	.13/Ft.
5	50-Ft., 4-Cond. Modular Cable	278-365	5.99
..	100-Ft., 4-Cond. Modular Cable	278-366	11.99
6	Weather-Sealed Splice Connectors	64-3080	4/1.69
7	Weather-Sealed Tap Connectors	64-3081	4/1.89
8	Insulated Butt Connectors	64-3073	24/1.29
9	25-Ft. Outdoor 4-Cond. Cable	278-386	34.99



2-Line Adapter for Answerer

Allows your standard single-line answering machine to answer calls from either of two phone lines. Answerer plugs into adapter and adapter plugs into 2-line (RJ14) modular phone jack. Phone-line powered. **43-383 21.95**



Voice/Data Guard

Teleprotector®. Stops answering machine's outgoing message when you pick up the phone. Also prevents interruption of fax or modem transmission if someone picks up an extension phone. Modular, just plug in. **43-107 7.95**

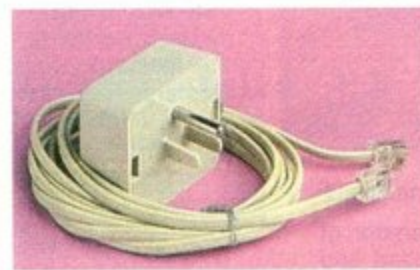

Phone-Line Spike Protector

Helps prevent damage to modems, phones, fax and answering machines due to voltage spikes on the phone line. Easy to install. Just plug into modular phone jack and a 3-prong AC outlet. **43-102 12.95**



Voice-Activated Tape Control

Same function as recorder controllers above. Voice-activation stops the recorder during pauses, saving tape and playback time. Easy way to keep a record of business info taken by phone. Requires 4 "AA" batteries. **43-263 34.95**

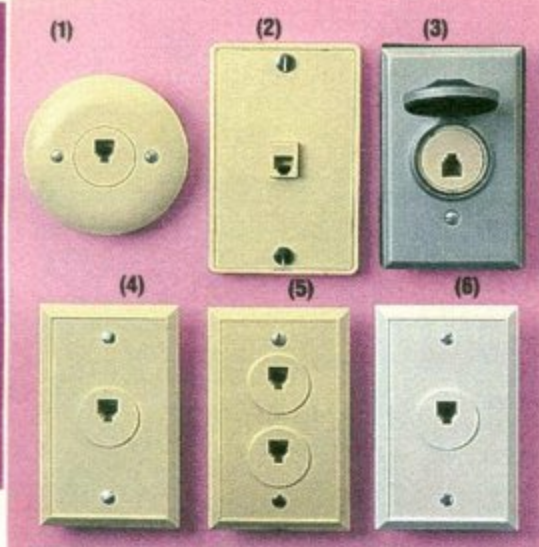

Wall Plates

- (1) **Round Modular Wall Plate.** Attractive wall plate with a standard modular (RJ11/14) phone jack. 279-392 3.95
- (2) **Surface-Mount Wall Phone Plate.** For modular-type wall phone. Mounts on wall surface, does not require an electrical box. 279-382 5.95
- (3) **Outdoor Modular Wall Plate.** Has a standard modular phone jack with protective cover. Mounts in a standard empty electrical box. With weather-resistant sealing gasket. 279-342 8.95
- (4) **Rectangular Modular Wall Plate.** Mounts in a standard empty electrical box. 279-352 ... 3.95
- (5) **Dual Wall Plate.** Versatile. Can be used for up to four phone lines, for two phones with the same phone number, or as a convenient hookup point for a phone and an accessory such as an answering machine, fax machine, automatic dialer or computer modem. 279-350 5.95
- (6) **NEW! White Modular Wall Plate.** For one or two-line installations. Mounts in standard empty electrical box. Has labeled screw terminals for easy hookup. 279-204 3.95

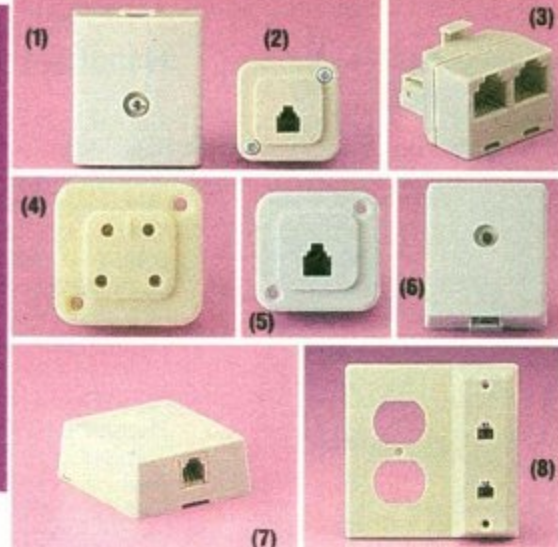

Phone Jacks

- (1) **Modular Quick-Connect Jack.** Installs over standard screw terminal-type wiring block and converts it to accept a modular phone plug. Color-coded leads with spade terminals. 279-355 2.19
- (2) **Modular Jack.** Like Fig. 1, but has snap-on clips in place of spade terminals. 279-386 2.99
- (3) **Modular Jack With Wiring Block.** 279-349 .. 3.95
- (2) **Surface-Mount Modular Jack.** Ideal for mounting on baseboard. 279-353 3.95
- (3) **Modular Duplex Jack.** Just plug in to convert one modular jack to two jacks so you can connect two devices, such as answerer and phone, or phone and modem or fax machine. 279-357 4.49
- (4) **Four-Prong Jack.** Accepts older-type 4-prong phone plug. Surface-mount. 279-367 3.39
- (5) **NEW! White Surface-Mount Modular Jack.** Ideal for baseboard. 279-202 3.95
- (6) **NEW! White Modular Jack With Wiring Block.** With mounting screws. 279-203 3.95
- (7) **Six-Wire Surface-Mount Modular Jack.** 3-line jack (RJ25C). 279-420 4.49
- (8) **Dual Modular Jack With AC Wall Plate.** Mounts by replacing wall plate on standard AC outlet. Can be used to provide two jacks for the same number or up to four separate phone lines. 279-415, 6.95

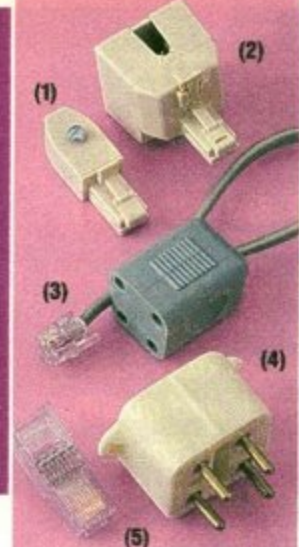

Plugs

- (1) **Modular Quick-Plug.** Adapts phone cord with spade lugs to a modular plug. 279-375 2.95
- (2) **Quick-Connect Modular Plug.** With insulation-piercing connectors. Fast hookup. 279-383 .. 3.95
- (3) **Quick-Connect Handset Plug.** Fits modular phone handset or handset outlet on phone. 279-298, 3.99
- (3) **Plug Adapter.** Just plug in to convert older 4-prong plug to fit modular jack. 279-393 3.49
- (4) **Four-Prong Plug.** Fits a 4-prong jack. (Fig. 4 in the column at left.) 279-366 2.79
- (5) **NEW! Eight-Pin Quick-Connect Plug.** For 8 conductor phone cable. Easy to install. Position conductors and press the hinged cover. 279-440 6.39

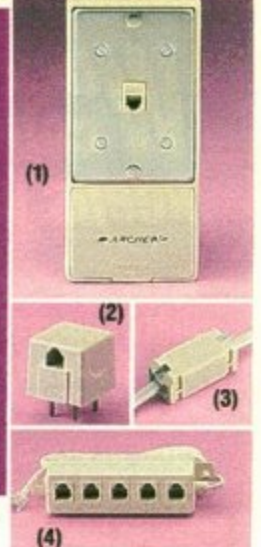

Adapters

- (1) **Modular Duplex Wall Phone Adapter.** Installs easily between wall phone and existing modular wall phone jack. Adds an extra modular outlet for connecting an answerer or other accessory. 279-359 .. 9.95
- (2) **Cord Adapter.** Converts a modular plug to fit an older 4-prong phone jack. 279-351 2.99
- (3) **Inline Coupler.** Connects two 4 conductor modular cords. 279-358 2.49
- (3) **6-Cond. Inline Coupler.** 279-423 .. 2.95
- (4) **Five-Outlet Modular Adapter.** Converts one standard modular jack to five modular jacks. 279-410 .. 9.95



Line Tester
NEW! For single-line and 2-line jacks. Just plug in and LEDs show if the line is correctly wired, reverse-wired or not operational.
 43-104 5.49
 Available Sept. 30, 1992

Outdoor Phone Wiring Box

NEW! This sturdy molded box has a hinged door with a weather-sealed lip. Four terminals.
 279-343 6.95
 Available Sept. 30, 1992



Terminal Blocks

- (1) **42A Connector.** Standard 4-conductor, wall-mounting terminal accepts spade lugs and wires. 279-389 ... 2.19
- (2) **Entrance Bridge.** Screw terminals provide connecting point for the phone company wiring and your phone wiring. 279-394 5.95



- Modular Plugs and Tool**
- (1) **4-Conductor Modular Plug.** Std. RJ11/14. 279-384 ... Pkg. of 10/2.99
 - (1) **6-Conductor Mod. Plug.** RJ11/14/25. 279-421 Pkg. of 10/3.99
 - (2) **Crimping Tool.** Attaches modular plugs to modular cord. 279-388 8.95

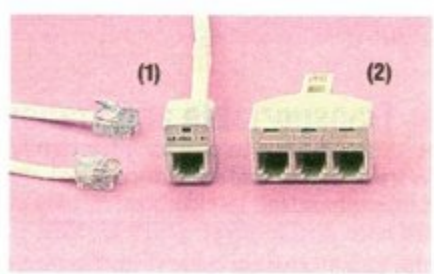

- Two-Line Coupler and Jack**
- (1) **Two-Line Coupler.** Combines two single lines (separate RJ11 jacks) into a 2-line (RJ14) jack. 279-401 6.95
 - (2) **Three-Way Jack.** Adds two single-line jacks to a 2-line jack. Connect answerer to either line. 279-402 6.95



- Business Phone 4-Line Tap**
- Increases versatility and saves money by allowing you to connect single-line phones, answerers, automatic dialers, fax machines and other devices to your 1A2-type multiline business telephone system. Do it yourself and avoid high installation costs. 43-270 19.95



- Handset Cord Untangler®**
- Ends annoying tangles. This plug-in swivel connector prevents knotting of handset cord and extends its life. Plugs into the handset or base of any phone that has a detachable modular handset cord. Get one for every phone!
 279-299 4.99

When seconds count, cellular keeps you in touch

Tandy cellular phones are designed and engineered by one of the world's largest makers of cellular telephone equipment, and quality-built in our own state-of-the-art manufacturing plant. They feature sturdy, reliable surface-mount technology and noncorrosive gold-plated keypad contacts. It's attention to details like these that produces the quality and performance you expect.

In addition, our phones have dual NAM to save roaming charges by letting you have a local cellular phone number in two different cities. Ideal for anyone who needs two numbers.

Let's Talk About Cellular Pricing*

Radio Shack and our cellular telephone carriers across the country work to keep cellular telephone prices as affordable as possible. In most cases, your new activation and minimum service commitment will result in substantial savings over the unactivated price. However, cellular carriers may require certain activation fees and service deposits that are beyond our control.

Prices are subject to change and may vary depending on carrier participation, market conditions, the service plan selected, and changes in federal, state or local law as they affect the cellular telephone industry. Some carriers offer limited-usage plans that provide a lower monthly service charge, but with a higher airtime charge.

Type of Service	Typical Monthly Service Charge	Typical Cost Per Peak Minute	Typical Monthly Cost for Service with 20 Minutes Use	Typical Monthly Cost for Service with 200 Minutes Use
Basic	\$50.00	.40	\$58.00	\$130.00
Economy	\$15.00	.70	\$29.00	\$155.00

These limited-usage plans may result in a higher retail price of the cellular phones, but with a lower total annual cost.

Tandy Model	Without Activation	Activation With Basic Service Plan	Activation With Economy Service Plan	California
CT-302	549.95	299.95	424.95	399.95
CT-350	649.95	399.95	524.95	499.95
CT-103	449.95	199.95	324.95	299.95
CT-1033	549.95	299.95	424.95	399.95
CT-1030	449.95	199.95	324.95	299.95

Minimum service commitment required.

Discuss your cellular calling needs with one of our trained professionals to determine the service plan that's right for you.

Activation is available nationwide through Radio Shack but not required in California.

This statement and pricing are as of catalog printing date. For complete details, visit any participating Radio Shack store or dealer.



(1)



With Desktop Charging Stand

Handheld Portables

Put the whole world in your hand! Stay in touch wherever you go—from your car to job site to pleasure boat. Carry with you to confirm a last-minute appointment or close a business deal.

(1) **Tandy® CT-302.** Only $7 \times 2\frac{3}{16} \times 1\frac{3}{8}$ " and weighs just 15.9 oz. with battery. Elapsed time counter, 40-number memory, redial, memory scroll, large LCD, backlit keys, illuminated display, electronic lock, volume control, signal strength meter. 600-milliwatt output. Includes rechargeable battery, charging stand, UL listed AC adapter, carry case. (TSP) 17-1051 299.95*

(2) **NEW! Tandy CT-350.** Our smallest— $6\frac{5}{8} \times 2\frac{3}{16} \times 1\frac{5}{16}$ ", weighs 11.1 oz. with battery. Easy-to-use, menu-driven illuminated supertwist display and backlit keypad, built-in antenna, 48-number memory, alpha-memory stores phone number by name, redial, call timer, volume control, adjustable ringer volume, signal and battery strength indicators. 600-milliwatt output. Includes rechargeable battery, charger, carry case. (TSP) 17-1060 399.95*



(2)



Includes Charger



(1)



(2)



(3)

Full-Power Mobile, Transportable and Transmobile Cellular Telephones

(1) **NEW! Tandy CT-103 Mobile.** A small price to pay for your family's safety and security while on the road. If help is needed, the police, a tow truck or medical assistance is just an in-car phone call away. Features handsfree to make and take calls without lifting handset, backlit display and keyboard, 30-number memory. 3-watt output. Includes mounting hardware and bracket. (TSP) 17-1077 199.95*

(2) **Tandy CT-1033 Transportable.** Use in your car (plugs into the cigarette lighter) or carry it with you. The 3-watt output—even when operating on the internal battery—is five times that of many portables. Switch to 0.6 watts to save battery power and extend talk time. Features 30-number memory, adjustable handset volume, last-number redial, cumulative call timer, electronic lock. Includes battery, carrying case, portable antenna, DC adapter/charger and UL listed AC battery charger. (TSP) 17-1006 299.95*

(3) **Tandy CT-1030 Transmobile.** No installation—just strap to seat, plug into cigarette lighter and you're ready to make and take calls. Moves easily from car to car—ideal for rental cars or when family members are traveling. Features handsfree mike, 30-number memory, backlit display and keyboard. Switchable 3-watt/0.6-watt output. Includes carry bag, antenna, lighter plug and coiled cords. (TSP) 17-1020 199.95*

*Requires new activation and minimum service commitment with Radio Shack cellular phone carrier except where prohibited by law. CT-302: \$549.95 without activation. CT-350: \$649.95 without activation. CT-103: \$449.95 without activation. CT-1033: \$549.95 without activation. CT-1030: \$449.95 without activation. Price in California is \$399.95 for CT-302, \$499.95 for CT-350, \$299.95 for CT-103, \$399.95 for CT-1033, and \$299.95 for CT-1030, with activation available but not required. See above for our cellular pricing policy. Prices apply at participating Radio Shack stores and dealers.

Digital Numeric Display Pager



(1)



Be reachable
at job sites

**Easy-to-use pagers
for families and
businesses**

(1) NEW! Tandy PersonalPager™. When you need to stay in touch, but can't stay by the phone, a Tandy Pager is the affordable answer. Perfect for business people and active families—customers, friends, even the babysitter can reach you. Stores 16 messages, your pager displays phone number to be called in memory. Switchable audible or silent alert, easy message delete and lighted digital display. Slim design clips to your belt—or carry in your purse. Requires "AA" battery. Available in most stores. Available Sept. 30, 1992.

17-6000 99.95*

(2) NEW! Tandy Nationwide Pager. As above, but now clients, associates and family can reach you, day or night, whether you're across town or across the country. Here's how it works. Callers dial your toll-free 800 service number. Your personal greeting instructs them how to leave a message. Then sophisticated satellite technology transmits the message to your pager. Voice message option may also be available from paging service provider. Available by special order.

17-6010 179.95*

PersonalPager is a trademark of MCCA



You're never more than a phone call away



**Activation and paging service fee extra

Antennas and Accessories to Help You Get the Most From Your Cellular Phone

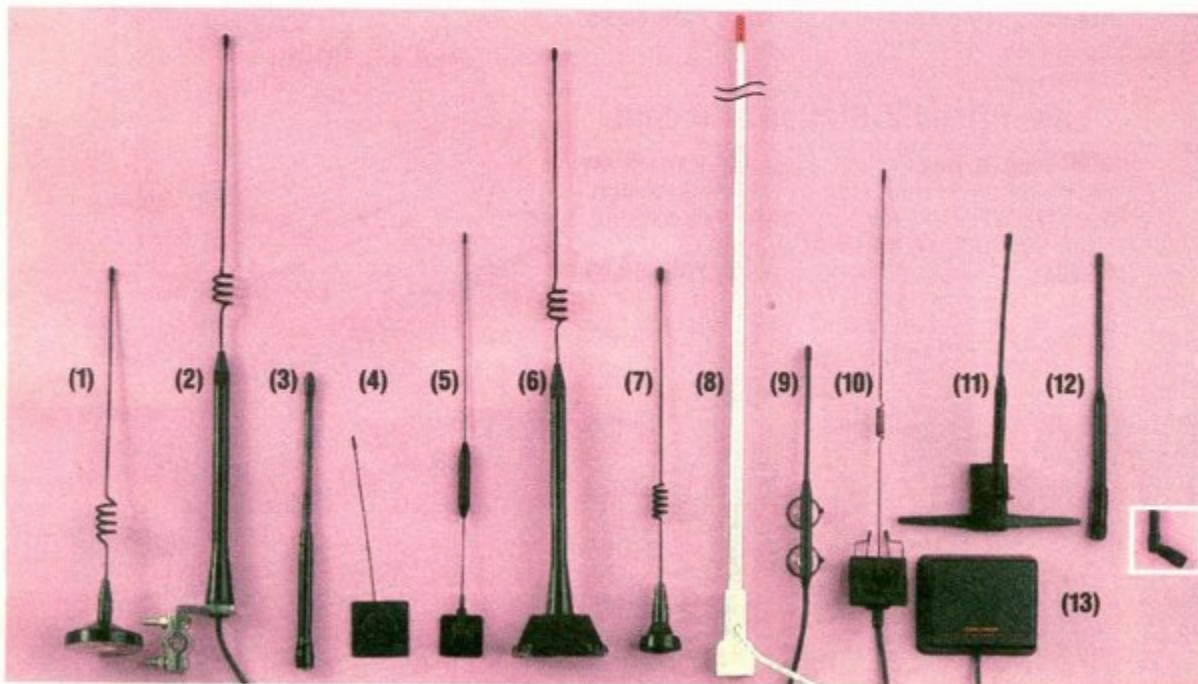

- (1) **Magnet-Mount.** Attaches to metal roof or trunk. 3 dB gain. 17-302 24.95
- (2) **Mirror-Mount.** 3 dB gain. 17-312 39.95
- (3) **High-Gain Portable.** For many portable phones. 3 dB gain. 17-307 29.95
- (4) **Glass-Mount.** A popular choice. 3 dB gain. 17-309 29.95
- (5) **NEW! Encapsulated Glass-Mount.** Improved performance in fringe areas. 5 dB gain. 17-320, 39.95
- (6) **No-Hole Trunk-Mount.** Elevated feed design installs on trunk lid. 3 dB gain. 17-311 39.95
- (7) **Roof-Mount.** "Snap-in" mounting. 3 dB gain. 17-306 24.95

- (8) **Marine Cellular.** Corrosion-resistant fiberglass. 4 dB gain. Requires #19-102 mount. 17-313 .. 59.95
- (9) **Suction Cup.** Attaches to window glass. Use with handheld phones in car or office. 17-314 ... 24.95
- (10) **Clip-On Glass-Mount.** Easy to install on car's side window—ideal for rental cars. 17-315, 44.95
- (11) **Portable Clip-On.** Use a handheld in your car without connecting an antenna cable. 17-316, 44.95
- (12) **Adjustable Angle Antenna.** Pivots 45° to 90°. 3 dB gain. 17-317 19.95
- (13) **NEW! Radome Cellular.** Spaceage microstrip technology. Low-profile magnet-mount antenna attaches to roof or trunk. 17-321 49.95

- CT-302 Mobile Mounting Kit. 17-606 79.95
- CT-302 Rapid Battery Charger. (CMC) 17-605 89.95
- CT-300/301 Handsfree PC Interface. (CMC) 17-601 69.95
- CT-300/301 Extra Rechargeable Battery Pack. 17-604 54.95
- NEW! CT-350 Extra Rechargeable Battery.** 17-608 49.95
- NEW! CT-350 Slim-Line Rechargeable Battery.** (CMC) 17-609 79.95
- NEW! CT-350 Rapid Battery Charger.** (CMC) 17-615 79.95
- NEW! CT-350 Mobile Adapter.** (CMC) 17-616 39.95
- NEW! CT-300/301 Rapid Battery Charger.** (CMC) 17-611 49.95
- 3-Foot Cellular Phone Extension. 278-976 .. 4.99
- TNC Push-On Adapter. 278-133 3.99
- PC/FAX Interface. (CMC) 17-504 69.95
- Wiring Harness/Interface. (CMC) 17-705 ... 39.95
- Horn Alert Kit. (CMC) 17-704 39.95
- Long Handset Cable. (CMC) 17-706 24.95
- Extra CT-302 Rechargeable Battery. 17-607 39.95
- Extra Charger for CT-1033. (CMC) 17-610 .. 54.95
- Extra CT-1033 Rechargeable Battery. 23-187 39.95
- CT-300/301 Charging Stand. (CMC) 17-602 64.95
- CT-300/301 Mobile Mounting Kit. 17-603 ... 24.95
- CT-300/301 DC Battery Eliminator. (CMC) 17-612 39.95

RADIO SHACK STOCKS A COMPLETE SELECTION OF ANTENNAS AND ACCESSORIES FOR YOUR CELLULAR PHONE

Wireless FM Intercom systems keep you in touch

Step-savers! Desk/wall stations plug into existing AC outlets to provide clear communication around home or office.

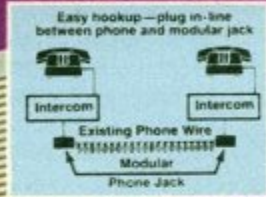

Intercom and Phone Hold

A low-cost way to add intercom and hold to phones. If the call is for someone at the other station, you can notify that person by intercom. Just plug system into AC and modular jack, then plug phone into intercom. Intercom works even without phone attached. Locking Talk-bar, volume control. $1\frac{3}{4} \times 5\frac{3}{4} \times 4"$. UL listed AC. 43-206 PAIR 49.95



Portable Room Monitoring System

Now you can monitor an area such as a child's room, play area or dependent person's room as you move freely around the house. Transmitter, $2 \times 5\frac{1}{4} \times 4\frac{3}{8}"$, is UL listed AC. Receiver, $5 \times 2\frac{1}{2} \times 1\frac{1}{8}"$, requires 9V battery for portable use. 43-202 39.95 Flexible Antenna. For receiver. 43-189 5.49



Our Best! Stylish 3-Channel, 3-Station System

NEW! A snap to use—just plug in and press Talk-bar to speak. Each station features selectable 3-channel operation so you can talk with one station without disturbing the other. Or, select a single channel for 3-way conferences. Call-tone button, lockable Talk-bar. $1\frac{5}{8} \times 5\frac{13}{16} \times 4\frac{1}{8}"$. UL listed AC. (TSP) 43-219 SET OF 3, 99.95

2-Station With Lighted Talk-Bar

NEW! Deluxe Plug 'n Talk® System. Available in three FM frequencies to reduce noise and interference. Talk-bar doubles as a night-light. Call-tone button, lock-bar. $1\frac{3}{4} \times 6\frac{3}{4} \times 4\frac{3}{4}"$. UL listed AC. (TSP) 43-224 PAIR 69.95



Low-Priced 2-Station Intercom

NEW! Plug 'n Talk System. Press Call-button on either station to send alert to the other station. Lockable Talk-bar allows continuous monitoring. $1\frac{7}{8} \times 5\frac{7}{8} \times 4"$. UL listed AC. 43-204 PAIR 39.95



Two-Station Wired

Battery-powered for noise-free conversation in home, camper or boat. Can signal other station even when "off". Master has volume control. With 66-foot cable. Each $1\frac{1}{2} \times 1\frac{1}{2} \times 4\frac{1}{8}"$. Requires 9V battery. 43-222, PAIR 14.95



Four-Station Wired

Selector on master station lets you talk with remote stations individually. With three 66-foot cables. Master, $1\frac{1}{2} \times 4\frac{1}{8} \times 4\frac{3}{4}"$. Remote stations, $1\frac{1}{2} \times 3\frac{7}{16} \times 4\frac{1}{8}"$. Requires 9V battery or AC adapter. 43-223 24.95



Scanner radios make your home an informational "command headquarters"

Realistic® scanners bring you the most exciting listening of all—local events as they happen, not hours later through an edited newscast. You'll hear police, fire, ambulances, amateur radio, weather, trains and taxis, plus government, military, marine and business services. Scanners covering the 108-136 MHz or 200-300 MHz AM band also receive commercial and military aircraft. (All other bands are FM.)

Programmable scanners offer keyboard entry of frequencies and have memories to store your favorite channels. Backup system preserves programmed frequencies during power outages. Zeromatic® tuning locks precisely on, not "around", the selected frequency for best possible reception. All are ready to use with built-in speaker, squelch control to silence speaker between calls, plus a detachable indoor antenna on desktop models and a jack for an outdoor antenna.

F.Y.I.

Most Realistic scanners offer these features

SCAN-DELAY. Locks receiver on-channel for two seconds after a transmission so you can hear any reply.

SEARCH MODE. Automatically finds new or unpublicized frequencies.

PRIORITY. Auto-locks onto a selected frequency whenever it is active.

LOCKOUT. Bypasses unwanted channels.



Our Best! 400 Channels and Two-Speed HyperScan

- Military and commercial aircraft bands
- Access to over 196,000 frequencies
- Smart Squelch™ prevents lock-up on channels without voice—you don't miss any action

Realistic PRO-2006. You can hear 800-MHz police/emergency, CB, FM, TV audio, even military aircraft. HyperScan™ system doubles scanning speed to 26 channels per second—scan 400 channels in about 15 seconds. Ten 40-channel memory banks, 10-channel temporary bank and favorite-channel priority. Auto/manual mode step selection. Covers 25-520, 760-823, 851-868 and 896-1300 MHz. Jacks: tape out, 1/8" headphone, external speaker, BNC antenna. Multifunction LCD display. Memory backup requires 9V battery. UL listed AC (or 12VDC cord, extra) **20-145** **399.95**



200 Channels, Search & Priority

- 800 MHz police and emergency band
- Switchable manual and scan mode
- Scan-delay for listening to replies

Realistic PRO-2022. Access to over 32,000 frequencies. Has ten 20-channel memory banks, a 10-channel monitor bank for temporary storage of frequencies found during search, and priority. Easy-to-read display, built-in speaker, squelch control. Covers 30-54, 108-136, 138-174, 380-512, 806-823, 851-868 and 896-960 MHz in ten bands. Jacks: 1/8" headphone, external speaker, BNC antenna. Memory backup requires 9V battery. UL listed AC (or 12VDC cord, extra) **20-127** **299.95**

Mobile Mounting Bracket. For 20-127 and 20-145. (CMC) **20-0001** **24.95**

Home and mobile programmable scanner radios



8-Channel, VHF-Hi/UHF, Weather Search

Realistic PRO-59. Keyboard access to 20,000 frequencies. WX search auto-seeks latest National Weather Service broadcasts. Lockout. Coverage: 137-174 and 406-512 MHz in six bands. Jacks: ext. antenna and speaker. UL listed AC adapter. (TSP) 20-401, 99.95



10-Channel, VHF/UHF Hi/Lo, Full Display

Realistic PRO-58. Access to 22,000 frequencies. Backlit LCD channel/frequency display. Manual/scan, lockout, scan-delay. Coverage: 30-54, 138-174, 380-512 MHz. Ext. antenna jack. UL listed AC adapter (or 12VDC cord, extra). (TSP) 20-400 129.95



20-Channel, Air Band, Weather Search

Realistic PRO-2023. Access to 22,000 frequencies, including 108-MHz aircraft band. One-touch National Weather Service broadcasts, search, favorite-channel priority, lockout, scan-delay. Coverage: 29-54, 108-174, 406-512 MHz. Jacks: external antenna, 1/8" headphone/speaker. UL listed AC. (TSP) 20-128 159.95



60-Channel, Search and Monitor Bank

Realistic PRO-2024. Access to 23,000 frequencies. Monitor bank stores frequencies found during search for transfer to permanent memory. Two-speed scan/search, priority, lockout, scan-delay. Coverage: 30-54, 118-136, 138-174, 380-512 MHz. Jacks: ext. antenna, 1/8" headphone/speaker. UL listed AC. (TSP) 20-129, 179.95



Catch the Action as You Drive

(1) **Realistic PRO-2025 16-Channel Mobile Scanner.** Access to 22,000 frequencies in 10 bands. Auto-searches for active frequencies and stores any channel on any band. One-touch weather search, manual/scan, priority, lockout, review key. LED display, memory backup. Coverage: 29-54, 136-174, 406-512 MHz. Built-in speaker, jacks for antenna and external speaker. With mobile mounting bracket and DC cord. 12VDC neg. gnd. (TSP) 20-146 129.95

(2) **NEW! PRO-2026 100-Channel Mobile Scanner.** Access to 30,000 frequencies including aircraft and 800-MHz public-service bands. Five band-search keys allow scanning of pre-programmed frequencies in police, fire, air, weather and marine bands, even if you don't know the frequencies. Manual/scan, search, monitor, priority, lockout, scan-delay. Multifunction LCD display. Memory backup. Coverage: 29-54, 108-174, 406-512, 806-823, 851-868, 896-956 MHz. Built-in speaker, jacks for antenna and ext. speaker. Mobile mounting bracket, DC cord. 12VDC neg. gnd. (TSP) 20-148 199.95

Accessories to increase your scanning enjoyment

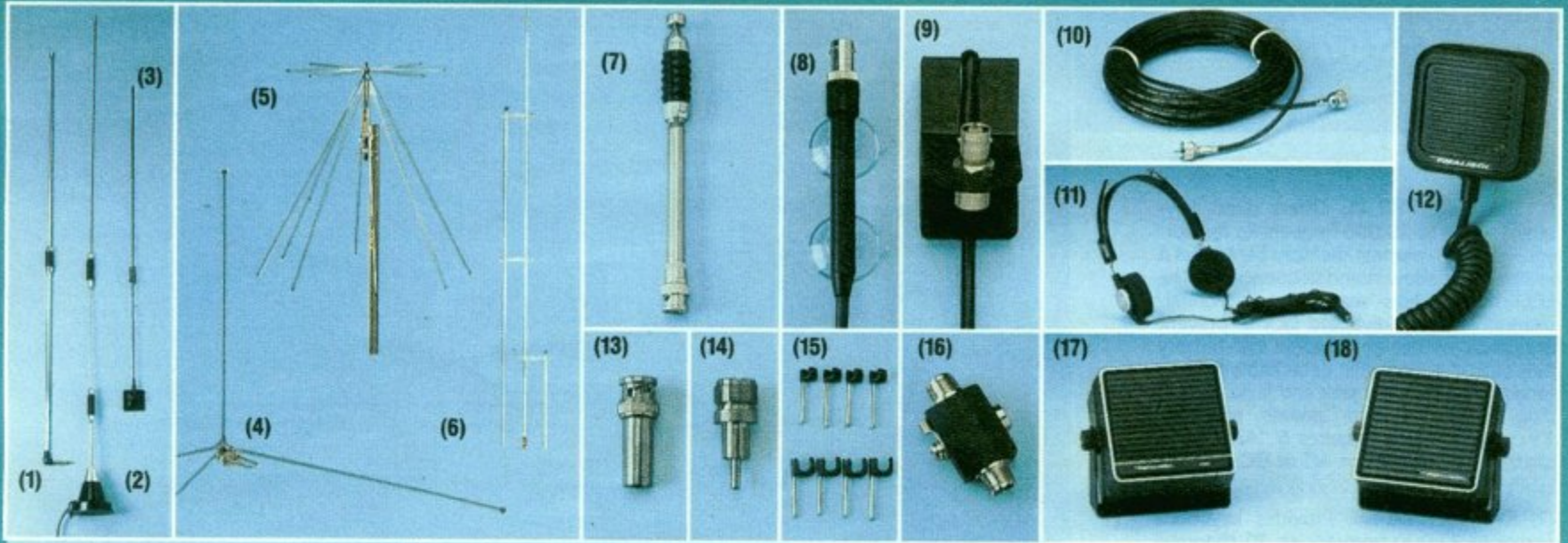

Performance-Boosting Antennas and More for Your Home, Mobile or Portable Scanner

- (1) **Indoor Plug-In All-Band Scanner Antenna.** Center-loaded, extends from 16" to 40". With Motorola-type plug. **20-161** **9.95**
- (2) **Magnetic-Mount Mobile Scanner Antenna.** With 16-foot cable, Motorola-type plug. **20-012** **29.95**
- (3) **NEW! Cellular "Look-Alike" Glass-Mount Mobile Scanner Antenna.** Pivots 90°. With 16-foot cable, BNC connector. **20-011** **29.95**
- (4) **VHF-Hi/Air/UHF Scanner Roof Antenna.** Accepts PL-259 connector. U-clamp mount fits masts up to 1½" diameter. **20-176**, **14.95**
- (5) **Discone Scanner/Ham Roof Antenna*.** Receives 25-1300 MHz. Accepts PL-259 plug. **20-013** **59.95**
- (6) **All-Band Roof Antenna.** Accepts PL-259 connector. Cable extra, below. **20-014** **29.95**
- (7) **Center-Loaded Scanner/Ham Whip Antenna*.** Receives 25-1300 MHz. Nine sections, BNC connector. **20-006** **9.99**
- (8) **NEW! BNC Antenna Glass Mount.** Dual suction cups hold antenna securely to inside face of window—great for use in a vehicle. With 6-foot cable. **20-022** **9.95**
- (9) **NEW! BNC Over-Glass Mount.** Mounts your flexible antenna outside vehicle. With 6-ft. RG-58 cable and BNC connector. **20-023**, **9.95**
- (10) **50-Foot Coax Cable Assembly.** 52-ohm RG-58 cable with PL-259 plug on each end. **278-971** **13.99**
- (11) **Communications Headset.** Monaural headset is perfect for use with Citizens Band and Ham radios, too. Adjustable headband, padded ear-cushions. With ¼" and ⅛" plugs. **20-210** **9.95**
- (12) **NEW! Clip-On Mini Speaker.** Really convenient. Swivel clip attaches to collar or lapel for easier listening while you carry your portable on its belt clip. Coiled cord with ⅛" plug. **20-009** **9.95**
- (13) **Scanner Antenna Plug Adapter.** Accepts Motorola-type plug, fits BNC jack. **278-117** **2.99**
- (14) **Scanner Antenna Plug Adapter.** Accepts PL-259 plug. Fits Motorola-type jack. **278-208** **1.79**
- (15) **RG-58 Nail-In Clips.** **20-192** **10/99¢ For RG-8 Cable.** **20-193**, **6/99¢**
- (16) **Antenna Surge Absorber.** Gas discharge tube. Rated 500W PEP, DC to 500 MHz. **20-021** **19.95**
- (17) **Amplified Speaker.** 4" speaker with 7.5-watt amp for extra volume from mobile/portable scanners, Ham radio, cellular phone, CBs. 12VDC neg. gnd. **21-541** **23.95**
- (18) **Extension Speaker.** 4" speaker. 10-foot cable with ⅛" plug. Handles 5 watts. With bracket. **21-549** **13.95**

Look for these features on Realistic® home and mobile scanners

Model and Cat. No.	PRO-2006 20-145	PRO-2022 20-127	PRO-2024 20-129	PRO-2023 20-128	PRO-58 20-400	PRO-59 20-401	PRO-2026 20-148	PRO-2025 20-146
Type	Home/Mobile	Home/Mobile	Home	Home	Home/Mobile	Home	Mobile	Mobile
Channels	400	200	60	20	10	8	100	16
800-MHz Band	✓	✓					✓	
200-400 Ham/Gov't. Military Aircraft	✓							
AM Aircraft Band	✓	✓		✓			✓	
Selectable AM/FM	✓							
Triple Conversion	✓							
Zeromatic Tuning	✓	✓						
Sound Squelch	✓							
HyperScan	✓							
Search	✓	✓	✓	Weather Only		Weather Only	✓	✓
Priority	Selectable	Selectable	Ch. 1	Ch. 1			Selectable	Ch. 1
Lockout	✓	✓	✓	✓	✓	✓	✓	✓
Scan-Delay	✓	✓	✓	✓	✓		✓	✓
Display	7-Digit LCD	7-Digit LCD	7-Digit LCD	6-Digit LCD	6-Digit LCD	1-Digit LED	7-Digit LCD	2-Digit LED

Rugged portable programmable action scanners

(1) **Realistic® PRO-41.** Offers direct keyboard access to 20,000 frequencies for storage in the 10-channel memory bank, plus a review key to show stored frequencies on the LCD display. Has scan-delay, individual-channel lockout, keyboard lock to prevent accidental entries and audible low-battery indicator. With belt clip, detachable flex antenna, BNC antenna jack and jacks for adding earphone and power adapters. 7³/₈ × 2⁵/₈ × 1³/₈". Requires 5 "AA" or rechargeable batteries or AC or DC adapter. (TSP) 20-301 **119.95**

(2) **Realistic PRO-42.** Provides keyboard access to 22,000 frequencies, 10 channels with auto-scanning and continuous monitoring, plus channel lockout, scan-delay and keyboard lock. Multifunction LCD display with backlight. With belt clip, detachable flex antenna, BNC antenna jack and jacks for adding earphone and power adapters. 7 × 2¹/₄ × 1⁵/₈". Requires 6 "AA" or rechargeable batteries or AC or DC adapter. (TSP) 20-302 **139.95**

(3) **Realistic PRO-36.** Features keyboard access to 24,000 frequencies—including aircraft band—plus 20 channels and a frequency-tracking front-end for top sensitivity. Also has search, lockout, scan-delay, keyboard lock, LCD display with backlight, and memory backup circuit for changing batteries. With belt clip, detachable flex antenna, BNC antenna jack and jacks for adding earphone and power adapters. 6¹/₂ × 2⁵/₈ × 1⁵/₈". Requires 6 "AA" or rechargeable batteries or AC or DC adapter. Was \$199.95 in 1992 Catalog. (TSP) 20-137 **New Low Price! 169.95**



Get a grip on the action! Look for these features on Realistic handheld programmable scanners

Model and Catalog Number	PRO-43 #20-300	PRO-39 #20-303	PRO-35 #20-136	PRO-36 #20-137	PRO-42 #20-302	PRO-41 #20-301
Number of Channels	200	200	100	20	10	10
800-MHz Emergency Band	✓	✓				
AM Aircraft Band	✓	✓	✓	✓		
HyperScan	✓	✓				
Zeromatic Tuning	✓	✓		✓		
Search	✓	✓	✓	✓		
Priority	✓	✓	✓			
Lockout	✓	✓	✓	✓	✓	✓
Scan-Delay	2-second	2-second	2-second	2-second	2-second	3-second
Memory Backup	Indefinite EEPROM	1 hour	1 hour	1 hour	1 hour	30 min.
Frequency Coverage (MHz)	30-54 118-174 220-512 806-823 851-868 896-999	30-54 108-174 380-512 806-823 851-868 896-960	29-54 108-174 406-512	30-54 108-174 380-512	30-54 138-174 380-512	29-54 137-174 406-512



Realistic PRO-35. Offers keyboard access to 20,000 frequencies, 100-channel storage in 10 banks, even local weather reports at the touch of one key. Search, priority, lockout, scan-delay, LCD display with backlight. Belt clip, detachable flex antenna, BNC antenna jack, earphone jack. $7\frac{1}{16} \times 2\frac{3}{4} \times 1\frac{3}{8}$ ". With detachable rechargeable Ni-Cd battery pack and UL listed AC adapter/charger. Was \$229.95 in 1992 Catalog. (TSP) 20-136 **New Low Price! 199.95**

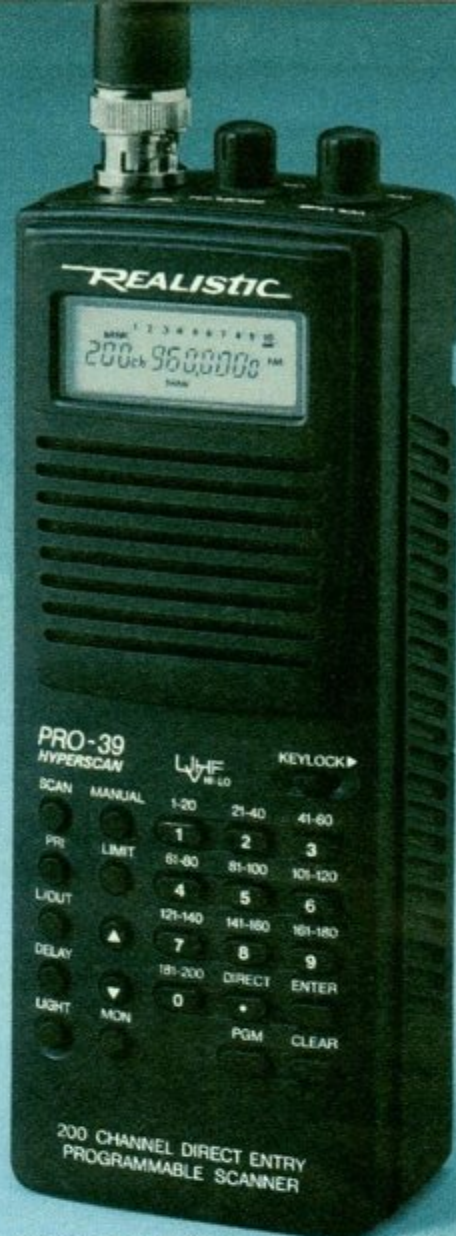

Realistic PRO-39. Keyboard access to 31,000 frequencies, 200-channel storage in 10 banks, 800-MHz band, HyperScan search and scan, 10-channel monitor bank, priority, lockout, scan-delay, LCD display with backlight, memory backup circuit. Belt clip, detachable flex antenna, BNC antenna jack, earphone jack. $5\frac{3}{4} \times 2\frac{3}{4} \times 1\frac{3}{8}$ ". Requires 6 "AA" or rechargeable batteries or AC or DC adapter. (TSP) 20-303 **299.95**

**Our best handheld
with 200 channels
and HyperScan**

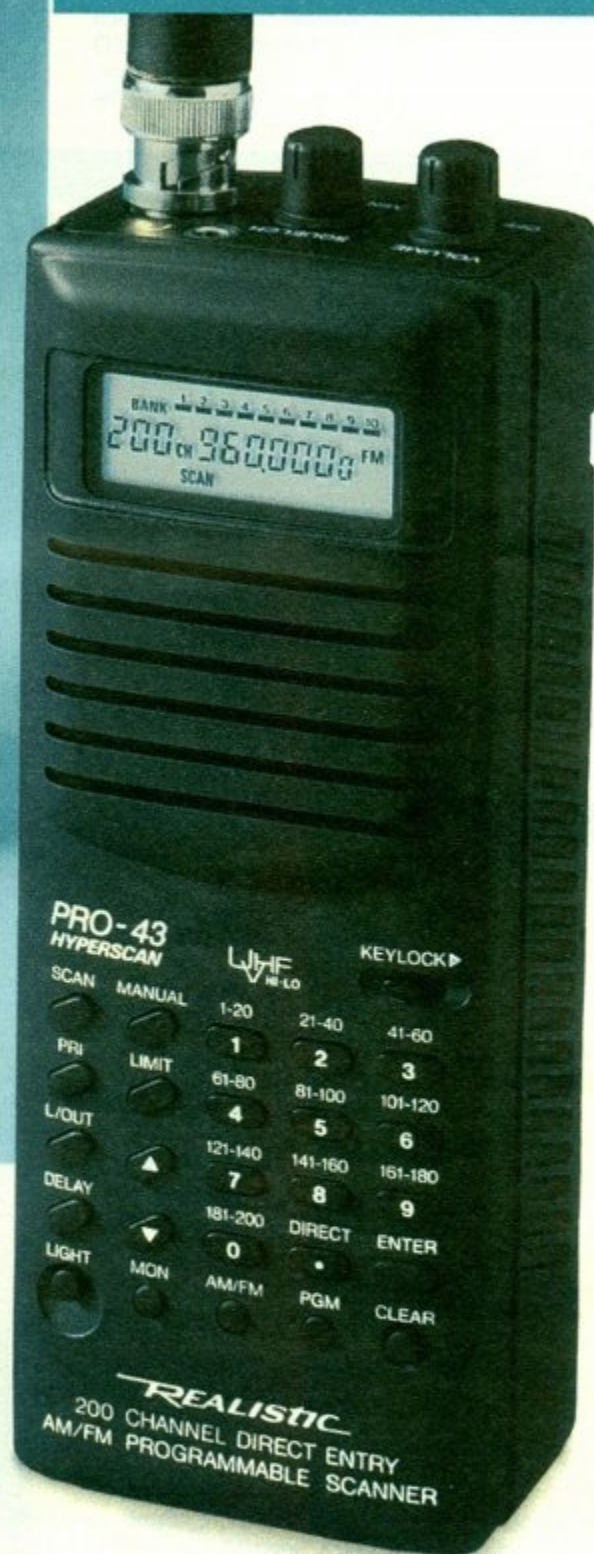

NEW! Realistic PRO-43. Get in on *all* the action with keyboard access to 48,000 frequencies including military aircraft and 800-MHz emergency-service bands. HyperScan™ system scans 25 channels/second and searches 50 frequencies/second. Triple-conversion receiver KO's interference. Auto/manual AM/FM mode selection, ten 20-channel memory banks, 10-channel monitor bank, priority, lockout, scan-delay, keyboard lock, audible low-battery indicator, LCD display with backlight, memory backup. With belt clip, detachable flex antenna, BNC antenna jack and jacks for adding earphone and power adapters. Built-in Ni-Cd charging circuit. $5\frac{3}{4} \times 2\frac{3}{4} \times 1\frac{3}{8}$ ". Requires 6 "AA" or rechargeable batteries or AC or DC adapter. (TSP) 20-300 **349.95**

AC Adapter/Charger. For #20-300/303. 20-188, 6.95



- Covers HF, VHF & UHF aviation radio frequencies in the USA
- Alphabetical listing by community

Official Aeronautical Frequency Directory. Gives FCC-authorized frequencies, frequency allocation charts, domestic/int'l designators. Over 400 pages. Special order (CMC). 62-1030 **21.95**



- Contains 27,000 listings covering Continental USA and District of Columbia

Official Marine Frequency Directory. Listen in on ship-to-ship, ship-to-shore, Navy, Coast Guard and more. Over 400 pages. Special order (CMC). 62-1031 **24.95**

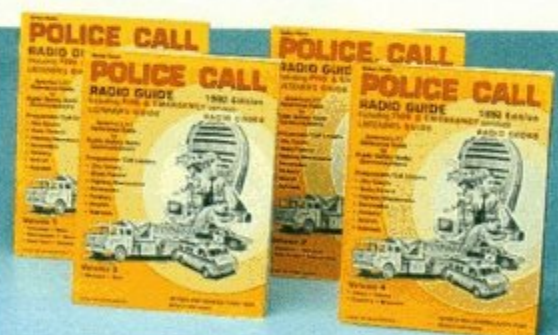

"Police Call" Frequency Guides. Nine fact-packed regional editions provide up-to-date call letters and frequencies for emergency and government services, amateur radio and more. ... **Each 9.95**

Volume 1. CT, ME, MA, NH, NY, RI, VT. 62-1041

Volume 2. DE, MD, NJ, PA. 62-1042

Volume 3. MI, OH. 62-1043

Volume 4. IL, IN, KY, WI. 62-1044

Volume 5. IA, KS, MN, MO, NE, ND, SD. 62-1045

Volume 6. DC, FL, GA, NC, SC, VA, WV. 62-1046

Volume 7. AL, AR, LA, MS, OK, TN, TX. 62-1047

Volume 8. AZ, CO, ID, MT, NM, NV, WY. 62-1048

Volume 9. CA, OR, WA. 62-1049



NEW! TRC-437. Electronic channel controls. Squelch and volume control. ANL. LED channel indicator, LED transmit/receive indicators. Remote speaker jack. Only 1 1/4 x 4 1/4 x 6 3/4". (TSP) 21-1553 59.95



NEW! TRC-438. Dual ceramic filters for superior clarity, automatic noise limiter, 4-step signal/RF power meter, remote speaker jack. 1 5/16 x 4 1/2 x 7". (TSP) 12-1552 69.95



NEW! TRC-481. On-mike and front-panel channel controls, emergency Channel 9 priority switch. Jacks for adding PA and remote speaker. 1 3/8 x 5 1/4 x 6 1/4". (TSP) 21-1550 79.95

Realistic is #1 in Citizens Band communications, with

You'll find a complete selection of CB radios at your nearby Radio Shack store. Nobody in the USA sells more. Choose from Realistic® mobiles for highway help and information, walkie-talkies for work and pleasure, or a base station for emergency monitoring and serious hobbyists. And complement your radio with a performance-boosting antenna and accessories. We've got it all.



TRC-479. Never drive "alone" again. Our lowest priced mini transceiver mounts easily under dash to provide extra security and convenience on the road. Automatic Noise Limiter (ANL) cuts pulse-type noise. Dual ceramic filters provide

superior selectivity and freedom from adjacent-channel interference. LED channel display and transmit/receive indicators. With jack for adding external speaker. Only 1 3/8 x 4 1/2 x 6 1/2". (TSP) 21-1519 49.95

(1) **NEW! TRC-90.** Channel 14, 100mW. Reliable CB communication at a low price. Two-way speaker/microphone, telescoping antenna, wrist strap. With crystals. 5 7/8 x 2 3/4 x 1 1/4". Requires 9V battery. 21-1612 19.95

(2) **NEW! TRC-91.** Three Channels, 300mW. Separate speaker and microphone, battery test button with LED indicator, telescoping antenna. With Channel 14 crystals, provisions for adding two more channels. 7 1/4 x 3 x 1 1/5". Requires 6 "AA" batteries. 21-1613 29.95

(3) **NEW! TRC-223.** Three Channels, 2 Watts. Ceramic filter, automatic noise limiter, adjustable squelch. Separate speaker and microphone, low-battery indicator. Jacks for adding external antenna, AC charger and DC power. With Ch. 14 crystals, provisions for adding two more channels. 7 1/2 x 2 1/2 x 2". Requires 8 alkaline or 10 "AA" rechargeable batteries. 21-1641 .. 49.95

(4) **NEW! TRC-224.** Three Channels, 3 Watts. Range-Boost, center-loaded antenna. Ceramic filter, ANL, adjustable squelch. Separate speaker and mike, hi/lo power switch, low-battery indicator. Jacks for adding external antenna, AC charger and DC power. With Ch. 14 crystals, provisions for adding two more channels. 7 1/2 x 2 1/2 x 2". Requires 8 alkaline or 10 rechargeable "AA" batteries. (TSP) 21-1642, 59.95



Two-Way CB Crystals

Channel	Cat. No.	Pair
5	21-1205	4.98
9	21-1202	4.98
11	21-1207	4.98
19	21-1219	4.98
30	21-1230	4.98
35	21-1235	4.98



TRC-482. Hear the latest weather info on 162.4, 162.475 and 162.55 MHz. Channel 9 priority. ANL, NB and PA controls. Jacks for remote and PA speakers. 1³/₈ × 6 × 7³/₄". (TSP) 21-1551 99.95



TRC-435. Tone and RF gain controls, switchable ANL, Ch. 9 priority, 5-step LED transmit indicator. PA monitor. Remote/PA speaker jacks. 1⁵/₂ × 5¹/₂ × 6⁵/₈". (TSP) 21-1518 . . **New Low Price! 99.95**



TRC-465. Offers 40 AM CB plus 80 upper and lower single-sideband channels. Switchable ANL, RF gain, SSB clarifier. PA/remote speaker jacks. 2 × 6¹/₈ × 8¹/₈". (TSP) 21-1567, **New Low Price! 169.95**

mobile, base and portable radios to keep you in touch



TRC-492. This dual-powered base/mobile station delivers superior reliability and clarity thanks to ANL and noise blanker circuits. Features "electronic rotary-type" channel selector plus emergency Channel 9 and Channel 19 priority buttons.

Also has LED signal-strength and channel indicators, RF gain, squelch and volume controls. Jacks for adding external speaker and headphones. Home AC or vehicle 12VDC negative/positive ground. 2¹⁵/₁₆ × 11¹/₈ × 8¹/₄". (TSP) 21-1549 149.95



REACT
Emergency Channel 9
Nationwide Monitoring
A 24-Hour
Help Network

Use of the CB Channel 9 is restricted to emergencies and traveler assistance by government regulation. In the event of emergency, broadcast your CLIP:

Call Sign—Identify yourself
Location—Be exact
Injuries—Give number and type
Problem—Give details

Air your CLIP repeatedly



(1) TRC-222. 40 Channels, 5 Watts. Red LED channel display. Center-loaded antenna, ceramic filter, ANL, squelch. Hi/lo power switch. Jacks for adding external antenna, AC charger and DC power. 7¹/₄ × 2¹/₂ × 2¹/₄". Requires 8 "AA" or 10 rechargeable batteries or DC adapter. (TSP) 21-1646 79.95

(2) TRC-207. 40 Channels, 5 Watts. Green LED channel display, ANL, ceramic filter, squelch. Hi/lo power switch. Detachable flexible antenna, jacks for adding external antenna, charger and DC power. 7³/₄ × 2³/₄ × 1³/₄". Requires 8 "AA" or 10 rechargeable batteries or DC adapter. (TSP) 21-1645 99.95

(3) NEW! TRC-226. 40 Channels, 5 Watts. LCD display, battery/RF meter, switchable backlight. ANL, ceramic filter, squelch. Hi/lo power switch. Center-loaded antenna, TNC connector. Jacks for adding earphone, hand mike, AC charger and DC power. 7¹/₂ × 2¹/₂ × 1³/₈". Requires 8 alkaline or 10 rechargeable "AA" batteries. (TSP) 21-1665 139.95

(4) TRC-409 Road Emergency System. Sets up in seconds. 40 channels. Ch. 9 priority. Magnet-mount antenna stores in 10¹/₂ × 4⁵/₈ × 2¹/₄" case. (TSP) 21-1500 69.95

(5) NEW! TRC-460 Road Emergency System. 40 ch. & 3 weather channels. Antenna. 9³/₄ × 2³/₄ × 1¹/₂" case. (TSP) 21-1559 89.95

CB Accessories

- Flexible "Rubber Ducky" Antenna. 21-980 7.99
- Protective Carrying Case. 20-004 9.95
- Ni-Cd Battery Charger. UL listed AC. 21-516 . . 6.99
- 12VDC Cord. Eight feet long. For portables with DC power jack. 270-1533 3.99
- Regulated 12VDC Supply. Uses AC outlet to power mobile CBs or walkie-talkies with a DC jack. Rated 2.5 amps. UL listed AC. 22-120 39.99

Realistic® 49 MHz FM-band 2-way walkie-talkies

These walkie-talkies offer reliable 2-way communications—ideal for biking, hiking, camping, job sites, warehouses and special events. No license is required for using this equipment, so anyone can enjoy keeping in touch. Quality-testing and a huge selection of accessories make Realistic #1 in communications.



(1) Realistic TRC-503. Features five channels for multi-unit use. Call-button transmits alert-tone signal. Has push-to-talk and volume controls, sensitive dual conversion receiver and a detachable belt clip. Transmission range up to 1/4-mile. 6 1/8" x 2 5/8" x 1 1/16". Requires 9V battery. **21-402** **Each 39.95**

(2) NEW! Realistic TRC-505. Ultrathin and five ounces light. Perfect for use with 21-402, above. Transmission range up to 1/4-mile. 4 3/4" x 2 5/8" x 1 1/32". Requires 9V battery. **21-405** **Each 24.95**

(3) Realistic TRC-504. The ultimate in hands-free communications! When you speak, the earpiece instantly becomes a voice-actuated mike. The walkie-talkie picks up your voice via the ear canal and transmits a clean signal. Each features a sensitive dual conversion receiver, selectable push-to-talk or hands-free automatic operation, VOX sensitivity and volume controls. With belt clip and four different earpieces for a perfect fit. System provides up to 1/4-mile range. 2 1/2" x 4 15/16" x 1 5/16". Each requires 9V battery. (TSP) **21-404** **Pair 89.95**

(4) NEW! Realistic TRC-506. Selectable hands-free voice-actuated or manual operation. Ideal for keeping in touch at work or play. Sensitive dual-conversion superhet receiver, volume and VOX sensitivity controls. With belt clip and adjustable headset. Up to 1/4-mile range. 4 9/16" x 2 1/2" x 1 5/16". Each requires 9V battery. (TSP) **21-406** **Pair 69.95**

(5) Realistic TRC-502. As above, but with 5-channel operation for multi-unit use. 5 1/2" x 2 15/16" x 1 5/16". Requires 9V battery. **21-403** **Each 49.95**

Only Radio Shack Has Everything in Accessories for CB Radio



Amplified Speaker. 7.5 watts. For CBs, scanners, cellular phones and ham radios. 1/8" jack. With 4-ft. cable, hardware, bracket. 8 ohms. 12VDC neg. gnd. **21-541, 23.95**



Extension Speaker. Easy to install for use with CB, scanner, cellular phone and more. Includes 10-foot cable with 1/8" plug. Handles 5 watts. 8 ohms. **21-549** **13.95**



NEW! Clip-On Mini Speaker. For scanners and walkie-talkies. Clip rotates 360°, attaches to collar or lapel. Includes coiled cord with 1/8" plug. **20-009** **9.95**



Slide-Mount. CB slides off bracket for safekeeping—helps prevent theft. Includes under-dash mounting hardware—easy to install yourself. **21-566** **17.95**



Portable Hump Mount. Flexible platform rests on floorboard, holds CB at an easy-viewing angle. Moves easily from one vehicle to another. **21-540** **17.95**



(1) NEW! Field Strength/SWR Tester. For tuning your antenna system to maximum efficiency. Measures amount of signal transmitted. Can be permanently coupled to equipment. Covers 3-30 MHz, handles up to 1000 watts. **21-523** **19.95**

(2) NEW! SWR/Power Meter. For accurate CB and HF ham radio antenna adjustments. Measures peak and average power. Low-insertion loss—can be permanently coupled to equipment. Covers 3-30 MHz, handles up to 2000 watts. **21-524** **29.95**



Dummy Load. For SWR or power meter transmitter tuneup or checking coax cable power measurements. DC-500 MHz. Handles up to 100 watts. **21-506** **21.95**



Surge Absorber. For use with coax cables. DC-1.5 GHz. Rated 500 watts PEP to 500 MHz. Connects inline. Includes SO-239 connectors at each end. **20-021** **19.95**



Dynamic CB Microphone. Standard mike includes coiled cord with 5-pin DIN connector that fits most CBs. With hanger and mounting hardware. **21-1172** **17.95**



Amplified CB Mike. Noise-cancelling—ideal for mobile use. Coiled cord with DIN-type plug. Requires Radio Shack #23-601 7V battery. **21-1175** .. **29.95**



Magnetic Mike Holder. Easy to mount and convenient to use—lets you hang up your CB microphone on dash. Magnet holds mike in place. **21-1130** **1.79**



Microphone Clip. Hang up your CB mike when not in use—put on most convenient part of dash in your vehicle. Includes screws to mount to vehicle dash. **21-923** ... **79¢**



12VDC 48" Cord. Replacement 3-pin power cable with plug. Fits Realistic and most other CBs. Fuse holder, color-coded wires. Requires 2-amp fuse. **21-550** **3.29**

Archer® mobile & A base CROSSBOW® citizens band antennas

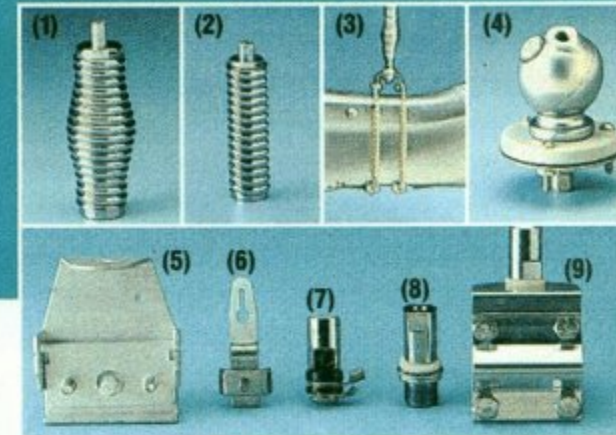

Deluxe Magnet-Mount Antenna

(1) Easy to install—no holes to drill! Mounts on any flat magnet-holding surface. Features low-loss coil form, 54" stainless steel whip, 16-foot cable and connector. **21-960** **37.95**

Base-Loaded Magnet-Mount

(2) Use on flat magnet-holding surface. Stainless steel whip, heavy-duty spring. Includes 16-foot cable, connector. **21-940** **26.95**

CB/AM/FM Antenna

(3) Mounts in standard radio antenna hole. Has 32" stainless steel whip, 8½-foot cable, splitter, radio and CB connectors. **21-990** **29.95**

No-Hole Trunk-Mount

(4) For center or side of trunk lid. Secures with set of screws. Base-loading coil, shock spring. With 16-foot cable, connector. **21-908** **26.95**

"Shorty" Snap-In Roof-Mount

(5) Features center-load coil, steel whip and shock spring. 16-foot cable and connector. **21-906** **23.95**

Trunk-Mount Cellular "Look Alike"

(6) Compact and stylish performer. 16-foot cable and connector. **21-991** **29.95**

Magnet Cellular "Look Alike"

(7) No holes to drill. With 16-ft. cable. **21-992**, **29.95**

Installation Accessories

- (1) **Steel Spring.** Chrome-plated, with removable 3/8" - diameter stud. **21-1118** **9.95**
- (2) **Slimline Spring.** Removable stud. **21-962** .. **8.95**
- (3) **Bumper Mount.** Includes dual chains. **21-910**, **12.95**
- (4) **Chromed Ball Mount.** With hardware. **21-1115**, **9.95**
- (5) **Gutter Clamp.** With hardware. **21-911** **5.99**
- (6) **Antenna Hold-Down Clip.** **21-917** **1.99**
- (7) **Antenna Feedthrough.** For whips or coils with standard 3/8" - diameter thread. Fits mounting plates up to 1/8" thick. **21-950** **4.99**
- (8) **Feedthrough/Adapter.** One end accepts standard PL-259 connector, other accepts whip or coil with 3/8" diameter thread. **21-961** **4.49**
- (9) **Mirror/Luggage Rack Bracket.** For whips with standard 3/8" - diameter thread. **21-937** **8.95**



New! Window Mount

(1) No ground plane—ideal for GM vans and fiber glass body vehicles. Fits any roll-up style window. Also for metal vehicles. **21-983** **29.95**

Fiber Glass Marine-Mount

(2) 48" long, horizontal or vertical mount. 16-foot cable, connector. **21-976** **37.95**

Single Truckers II

(3) Heavy-duty. Mounts on horizontal or vertical brackets. Center-loaded. 58" overall. 10-foot cable, connector. **21-941** **25.95**

Fiber Glass Twin Truckers

(4) Get superb reception with this top performer. Dual 48" whips. 18-foot cable. **21-945** ... **44.95**

Fiber Glass Single Truckers II

(5) With 10-ft. cable, connector. **21-939** ... **26.95**

Gutter-Clamp Antenna

(6) Stainless spring and whip. About 37" overall. 10-foot cable, connector. **21-909** **19.95**

Fold-Down Gutter-Mount

(7) Features center-loaded coil plus stainless steel spring and whip. Extends to about 38" overall. With 10-foot cable. **21-947** **26.95**

CROSSBOW® Base Antenna

(8) Omnidirectional 1/2 wave, rugged fiber glass, efficient 16-foot radiator. Mounting bracket fits masts up to 1 5/8" diameter. **21-967** **79.95**

Replacement Whips and More

- (1) **Back-of-Set CB Antenna.** **21-921** **7.99**
- (2) **102" Stainless Steel Whip.** **21-903** **13.95**
- (3) **102" Fiber Glass Whip.** **21-905** **12.95**
- (4) **48" Fiber Glass Whip.** **21-934** **10.95**
- (5) **Stainless Steel Whip With Adapter.** Replaces whip antennas 21-904/908/940, many other-brand whips. **21-952** **5.95**
- (6) **Coax Assemblies.** With dual PL-259 connectors.

Length	Cable	Cat. No.	Each
5 ft.	RG-8	278-969	6.49
10 ft.	RG-58	278-966*	6.99
50 ft.	RG-8	278-980	32.99
50 ft.	RG-58	278-971	13.99
2 ft.	RG-58	278-968	4.99

*Has PL-259 connector to spade lugs

Hams...communicate clearly with these Realistic transceivers

Amateur radio is the ultimate in hobby communications—an activity enjoyed worldwide by several million people. It is also an important link to the outside world in times of emergency such as earthquakes and severe weather. Now that the FCC has created the no-code Technician-class license, you can get on the air without having to learn Morse code. This makes it easier than ever to discover the exciting world of Ham radio. Come in to Radio Shack and get your start as a Ham.

Accessories Included!



Case for six alkaline batteries, belt clip, charger, Rubber Ducky antenna



Handheld 2-Meter Synthesized VHF-FM Transceiver*

- Includes large-capacity Ni-Cd battery pack and AC charger

Realistic HTX-202 2-Meter Transceiver. A solid performer built to commercial standards set by Radio Shack's in-house Hams. Feature-packed! Has 12 memory channels plus three priority channels, built-in touch-tone (DTMF) memory dialer and DTMF squelch, built-in sub-audible tone encoder and tone squelch. Multifunction scanning and LCD display. The highly selective receiver fights inter-mod and front-end overload. True FM transmit for superior clarity on voice and outstanding performance on packet. Memory dialer stores up to five 15 number sequences for selective calling or autopatch. May be operated directly from 12 volts with five watts minimum output. High/low RF power switch. With battery case for 6 "AA" alkaline batteries (extra). 6⁹/₁₆ × 2¹/₂ × 1³/₈". See footnote.* (TSP) 19-1120 259.95
Softcase. (CMC) 19-1121 9.95

Mobile SSB/CW Transceiver*

Realistic HTX-100 10-Meter Mobile Transceiver. Designed to be compact, durable and ideal for mobile use. Versatile enough for use as a novice's first rig or as an addition to an experienced operator's equipment. Digital VFO provides full 10-meter coverage and tunes in selectable 10 kHz, 1 kHz or 100 Hz steps. Memory stores 10 frequencies for recall. Also has noise blanker, RF gain control, squelch control and RIT control for fine-tuning. Lighted LCD frequency display, selectable 5 or 25-watt output, LED power/signal strength meter and convenient up/down tuning controls located on the mike. Operates USB (upper-sideband voice) and CW (code) with semi break-in keying and sidetone. Built-in speaker. Jacks: 1/8" for headphone, key, remote speaker. Standard 8-pin mike jack. With bracket, DC power cord. 2⁷/₁₆ × 7⁹/₃₂ × 7⁷/₈". 12VDC neg. ground. See footnote.* (TSP) 19-1101, 259.95

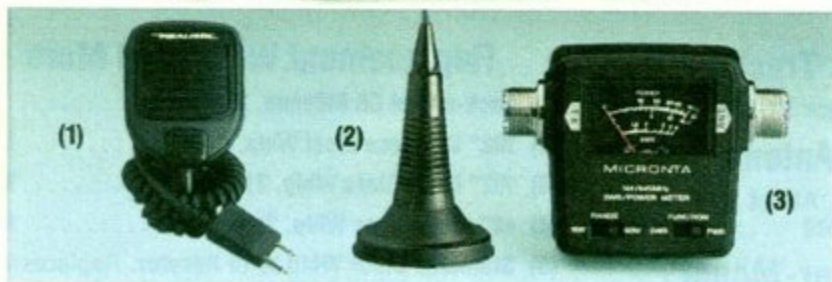

Convenient Accessories for Your Ham/CB Radio

- (1) **Handheld Speaker/Microphone.** Keep your Ham HT on your belt when operating "pedestrian/mobile". Icom/Yaesu compatible. 19-310 ... 19.95
- (2) **5/8" -Wave Magnetic-Mount 2-Meter Ham Radio Antenna.** Holds securely to any flat magnetic-metal surface. No holes to drill. 19-210 37.95
- (3) **VHF/UHF SWR/Power Meter.** For 2-meter and 70 cm Ham bands. Low insertion loss. Measures up to 60 watts. SO-239 connectors. 19-320, 39.95



Study Guides for the Amateur Radio Enthusiast

- No-Code Technician Class Manual.** 62-2413 9.95
- Novice Class License Preparation.** FCC test questions, answers. Two code cassettes. 62-2410 19.95
- Technician Class Manual.** 62-2411 4.95
- General Class License Preparation.** Manual, tapes. 62-2412 19.95
- Now You're Talking.** For Technician and Novice. 62-2414 16.95

*YOU MUST HAVE A CURRENT FCC AMATEUR LICENSE OF APPROPRIATE CLASS TO TRANSMIT WITH THE HTX-100 AND HTX-202

Transceivers to keep you in touch on land or at sea

Clear, dependable communication is essential for business and boating. Our new BTX-120 handheld transceiver can save time and boost efficiency in almost any business, large or small. Either of our marine transceivers is an excellent addition to a pleasure or commercial craft. These precision-crafted radios keep you in touch with other boats, shore stations and Coast Guard. They also receive NOAA weather broadcasts.

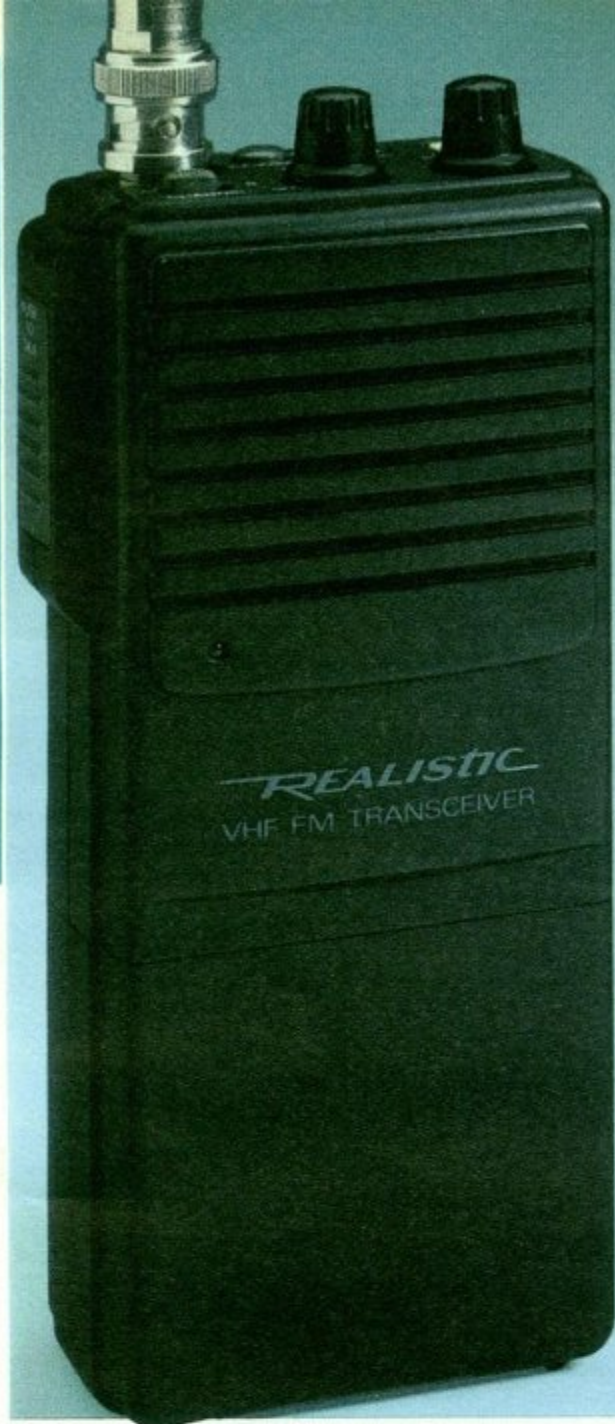

New! Handheld VHF-FM Business Transceiver

- Includes crystals for 151.625 MHz, battery and charger
- Powerful 1-watt output for up to 1-mile range

Realistic BTX-120 Transceiver. This handheld 2-channel transceiver is designed specifically for business use. It is ideal for construction sites, factories, warehouses, school campuses, hospitals—wherever dependable 2-way business communication is needed. The crystal-controlled circuitry precisely locks on-frequency without drift. You can easily add crystals for an additional channel. Adjustable squelch control eliminates noise between transmissions. Automatic level control adjusts for a wide range of voice levels to ensure clearly understandable transmissions. Battery low/transmit indicator shows the battery condition and lights when you receive or transmit. Includes removable rechargeable nickel-cadmium battery pack, UL listed AC charger, carrying case, belt clip, and detachable flex antenna. 6 x 2 1/2 x 1 1/2". (TSP)

19-1201 **149.95**

NOTE: Cannot be operated without FCC license. FCC license application included with unit. Fees will be required.

Spare Battery Pack. Available on special order through CMC.

19-301 Available Sept. 30, 1992 . . . **39.95**

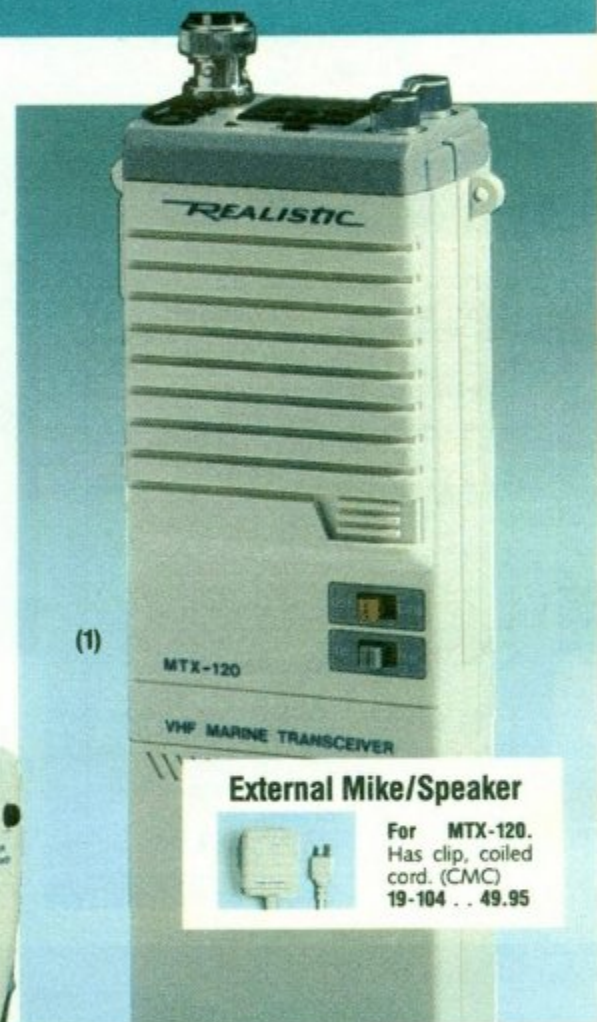

(1)

External Mike/Speaker



For **MTX-120.** Has clip, coiled cord. (CMC) **19-104** . . . **49.95**

Marine Transceivers

- Play it safe and equip your boat right with a Realistic 2-way radio

(1) **Realistic MTX-120.** Rugged, rechargeable portable provides full-featured 2-way communication on 54 U.S. or international VHF marine channels, plus the convenience of handheld portability. Also receives nine NOAA weather channels. You get one-touch pushbutton access to calling/emergency channel 16 for quick help, and selectable 5 or 1-watt power output. Detachable antenna. Includes high-capacity rechargeable battery pack and UL listed AC charger. 8 1/8 x 2 1/2 x 1 1/2". (TSP) **19-1050** **259.95**

Spare Battery Pack. (CMC) **19-103** **64.95**

(2) **Realistic MTX-101.** This deluxe 25-watt transceiver delivers crystal-clear ship-to-ship and ship-to-shore communications from pleasure boats or commercial craft. Selectable 25 or 1-watt power output. One-touch access to channel 16 for quick help in an emergency. Operates on 54 U.S. or international channels and receives nine NOAA weather channels. Jack for adding external speaker. Includes mounting bracket, hardware and detailed instruction manual. 2 3/4 x 8 x 9 3/4". 12VDC neg. gnd. (TSP) **19-1002** **229.95**

VHF MARINE RADIOS INCLUDE FCC LICENSE FORM AND TEMPORARY PERMIT. NOT LEGAL FOR LAND USE!

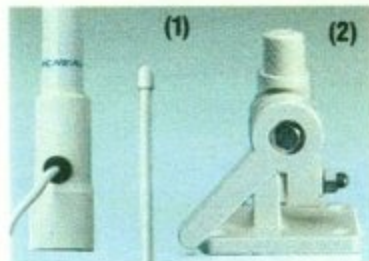

(1) **VHF Marine Radio 8-Foot Antenna.** Fiber glass—won't rust. Full 6 dB gain for maximum range. With 15-ft. cable. **19-101** **39.95**

(2) **Antenna Ratchet Mount.** Durable nylon and stainless steel construction—won't rust. **19-102** **14.95**



(2)

Hear news Hand views from around the world

Interesting, Educational, Wide Variety! Imagine hearing the news—in English or another language—from London, Moscow, Tokyo, Cairo or other major cities. Shortwave lets you keep up with news where relatives are traveling or working. You'll hear Hams worldwide, ships at sea and lots more. Reception conditions vary, so you don't always get every station every time. That's another reason why shortwave is a challenging and exciting hobby!

Model No.	Frequency Coverage
DX-390	AM, FM/FM stereo, LW, SW continuous 150 kHz to 29.999 MHz AM/SSB-CW
DX-380	AM, FM/FM stereo, LW, SW continuous 150 kHz to 29.999 MHz
DX-370	AM, FM/FM stereo (with headphones), shortwave 3.2-7.3 and 9.5-21 MHz
DX-350	AM, FM/FM stereo, SW (MHz) 5.85-6.20 (49m), 7.05-7.45 (41m), 9.45-9.90 (31m), 11.60-12.00 (25m), 13.55-13.85 (21m), 15.10-15.60 (19m), 17.45-18.00 (16m), 21.45-21.95 (13m), 25.70-26.15 (11m)
DX-343	AM, FM, SW (MHz) 5.90-6.20 (49m), 7.05-7.40 (41m), 9.50-9.90 (31m), 11.65-12.05 (25m), 13.55-13.85 (21m), 15.10-15.60 (19m), 17.50-17.90 (16m), 21.45-21.85 (13m)
DX-342	AM, FM, SW (MHz) 5.90-6.20 (49m), 7.05-7.40 (41m), 9.50-9.90 (31m), 11.65-12.05 (25m), 13.55-13.85 (21m), 15.10-15.60 (19m), 17.5-17.90 (16m).



Our Best World-Band Radio

Realistic DX-390. Digital tuning, dual-time LCD display and 45-station memory. BFO to hear SSB voice and CW (code). Scan tuning, wake and sleep controls. Requires 3 "AA" and 4 "C" batteries or AC or DC adapter. Was \$239.95 in 1992 Cat. (TSP) 20-214 **New Low Price! 219.95**

Digital Tuning 4-Band

Realistic DX-370. All-pushbutton digital tuning with LCD frequency display and 24-hr. clock. Memory stores 20 stations. Wake and sleep controls. 4 7/16 x 6 1/16 x 1 9/16". Requires 4 "AA" batteries or AC or DC adapter. (TSP) 20-211 **119.95**



New! Digital-Tuning All-Band AM/FM/SW/LW Radio

Realistic DX-380. Features 45 memories for instant station recall. Search lets you scan for the next available station. Use as clock radio with the wake and sleep controls. Dual time shows the primary clock plus the time in another city.

Battery back-up keeps clock running and preserves memory if power source is interrupted. 7 7/8 x 4 7/8 x 1 3/8". Requires 4 "AA" batteries or AC or DC adapter. Battery back-up requires 2 "AA" batteries. (TSP) 20-213 **179.95**

Compact Shortwave Receivers

(1) **NEW! Realistic DX-342 9-Band.** Pushbutton band selectors with LED indicators. FM stereo and tuning LEDs. Built-in speaker and headphone jack for private listening. External power jack. 2 3/4 x 5 x 1". Requires 2 "AA" batteries or AC or DC adapter. (TSP) 20-217 **69.95**

(2) **NEW! Realistic DX-343 10-Band.** Precise digital LCD clock shows local time plus world time for 260 cities. Alarm and 60-minute sleep timer. Built-in speaker. Jacks for stereo headphone and external power. 6 3/8 x 3 7/8 x 1 7/16". Requires 4 "AA" batteries or AC or DC adapter. (TSP) 20-218 **89.95**

(3) **Realistic DX-350 12-Band.** Easy to use portable is great for travelers. Slide-action band selectors, LED tuning indicator, built-in speaker, jacks for adding headphone and external power. 4 7/8 x 6 1/16 x 1 9/16". Requires 4 "AA" batteries or AC or DC adapter. (TSP) 20-209 **59.95**





New! Digital Tuning & Memory

Features LCD display, 10-station memory and auto station-search. Built-in clock with alarm and snooze. $4\frac{7}{16} \times 5\frac{5}{8} \times 1\frac{7}{16}$ ". Requires 4 "AA" batteries or DC adapter. **12-626, 39.95**



AM/FM/TV-Sound Portable

PortaVision®-40. Hear your favorite shows on VHF-TV channels 2-13, plus FM and AM. 4" speaker, earphone. $8 \times 10\frac{1}{2} \times 2\frac{5}{8}$ ". UL listed AC (or 4 "C" batteries, extra). **12-648, 39.95**

Portables for music and fun on the go

Radio Shack is America's #1 retailer of portable, table, kids', shortwave, and novelty radios. With a wide selection of over 50 models to choose from, we have the radio for you. After all, our first name is "Radio".



New! 6-Band Portable Receiver

- Tunes CB, SW, TV, VHF, plus AM and FM
- Add mike for use as portable PA system

Features fine-tuning control, 4" speaker, earphone. FM-AFC. $14\frac{1}{2} \times 10\frac{3}{4} \times 5\frac{3}{16}$ ". UL listed AC (or 4 "D" batteries or DC adapter, extra). (TSP) **12-649 99.95**

Available Sept. 30, 1992



We Have the AM/FM Portable That's Right For You

■ All have FM-AFC, slide-rule tuning dial and telescoping antenna

- (1) **Switchable AFC.** UL listed AC (or 4 "C" batteries, extra). **12-625 . . . 39.95**
- (2) **Mini Stereo.** Dual 3" speakers. Requires 4 "AA" batteries. **12-722 . . 29.95**
- (3) **Hi/Lo Tone Switch.** UL listed AC (or 4 "C" batteries, extra). **12-716 . . 24.95**



Pocket Radios That Perform Big

(1) **Pocket PortaVision.** Receives TV channels 2-13 audio plus AM and FM. $5\frac{1}{2} \times 3\frac{1}{2} \times 1\frac{3}{8}$ ". Requires 3 "AA" batteries or AC adapter. **12-614 29.95**

(2) **Jetstream® AM/VHF-Air.** Hear pilots talking to the control tower and other planes on 108-135 MHz band. With earphone. $4\frac{3}{4} \times 2\frac{7}{8} \times 1\frac{5}{8}$ ". Requires 9V battery. **12-601 19.95**



Travel Clock Radio

Wake to FM, AM, or "beep" alarm. Bright LCD time display. $3 \times 5\frac{3}{8} \times 1\frac{1}{4}$ ". Requires 2 "AA" batteries. **12-1571 19.95**



Rugged All-Weather AM/FM

Water and sand resistant for use almost anywhere. Reliable IC design, rotary controls. $3\frac{3}{4} \times 5\frac{1}{4} \times 1\frac{3}{4}$ ". Requires 4 "AA" batteries. **12-783 14.95**



AM/FM Flavoradios®

Feature FM-AFC, 2 $\frac{1}{2}$ " speaker, earphone and telescoping antenna. $4 \times 3 \times 1\frac{7}{16}$ ". Require 9V battery. **Strawberry, 12-720. Blueberry, 12-721 Each 9.95**

Delicious Flavoradios

Colorful pocket AM radios with built-in speaker. $4\frac{1}{8} \times 2\frac{5}{8} \times 1\frac{1}{4}$ ". Each requires 9V battery. **Blackberry, 12-201. Blueberry, 12-202. Strawberry, 12-203 . . . Each 6.95**



New! Stylish AM/FM Pocket Radios

(1) Take-along sound! FM-AFC, hi/low tone switch, 2 $\frac{1}{4}$ " speaker. Earphone, wrist strap. $5\frac{1}{3} \times 3\frac{1}{2} \times 1\frac{5}{16}$ ". Requires 3 "AA" batteries. **12-725 14.95**

(2) Slim size and rotary tuning/volume controls. Earphone and wrist strap. $4\frac{13}{16} \times 2\frac{3}{4} \times 1\frac{1}{4}$ ". Requires 2 "AA" batteries. **12-727 12.95**

Clock radios with battery backup

Chronomatic begins and ends your day right, with features, reliability and quality for less. Each is engineered for accurate timekeeping and precise tuning, so you get more stations more clearly. You can wake to your choice of an alarm or your favorite FM or AM radio station.

Chronomatic®



Battery Backup

If AC power fails, backup system keeps clock running up to eight hours, without display, and operates alarm at the preset time.

Battery Sentinel

Exclusive Battery Sentinel® system automatically tests the backup battery daily. The LED lights up to warn you if the backup battery needs replacement.



With Dual Alarm Settings

(1) Chronomatic-1268. With two wakeup times—ideal for working couples. Features up-front controls and a 0.6" fluorescent display with alarm "on" indicator. Snooze and sleep buttons. Fast/slow, forward/reverse, hour/minute buttons. 3 1/2" speaker, 1/8" earphone jack. 3 x 11 x 7". **12-1578 39.95**

(2) Chronomatic-272 Stereo. Features his and her wakeup settings, snooze and sleep controls, 0.6" LED display. Twin 3" speakers. 1/8" stereo headphone jack. 2 3/4 x 11 x 5 1/2". **12-1580 49.95**

(3) NEW! Chronosette®-276 Stereo/Cassette. Wake to alarm, radio or your favorite cassette. Features one-touch recording, tape auto-stop. Snooze, sleep, 0.6" display, lighted dial, dual 3" speakers and 1/8" stereo headphone jack. 5 x 12 3/4 x 6 1/8". (TSP) **12-1584 .. 79.95**

(4) Chronomatic-267. LED indicators for alarms and convenient up-front controls. Snooze resets alarm to turn on again in seven minutes. Sleep and time/alarm set buttons. 3 1/2" speaker, 1/8" earphone jack. 3 x 11 x 7". **12-1577 39.95**



With Built-In Telephone

Chronofone®-270. Space-saving combo! Phone features one-touch redial, can be set to automatically mute radio when handset is lifted from cradle. Clock has 0.6" LED display with hi/lo dimmer. Snooze and sleep controls, 3" speaker, 1/8" earphone jack. 3 3/4 x 8 1/2". Tone/pulse dialing—see page 8. **12-1572 49.95**



AM/FM/Cassette Player

Chronosette-273. Wake up or fall asleep to your favorite tapes. Has 0.6" LED display with dimmer, snooze/sleep. 2 1/2" speaker, 1/8" earphone jack. 9 1/4 x 5 7/8 x 2 3/4". **12-1581 39.95**



Built-In Night Light

Chronomatic-264. Features 0.6" LED display with p.m. and alarm indicators. Snooze and sleep controls plus time-set switch with lock, 3" speaker. 2 1/4 x 10 x 5 3/4". **12-1574 29.95**



Ultramodern Wedge Shape

Chronomatic-263. Large 0.9" LED display with hi/lo dimmer. Has up-front controls, top-mounted snooze and sleep buttons. 2 1/2" speaker. 4 1/2 x 8 1/4 x 4". **12-1573 27.95**

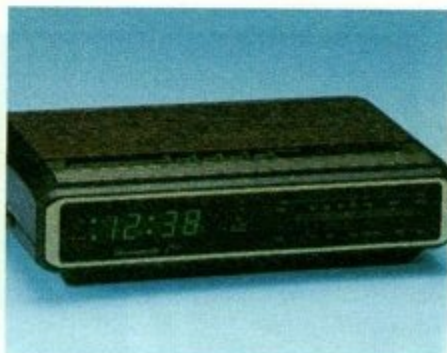

New! Green LED Display

Chronomatic-274. Green 0.6" LED display is easy on your eyes. Has snooze/sleep controls, 3" speaker, earphone jack. 2 5/8 x 10 1/4 x 6". **12-1582 24.95**

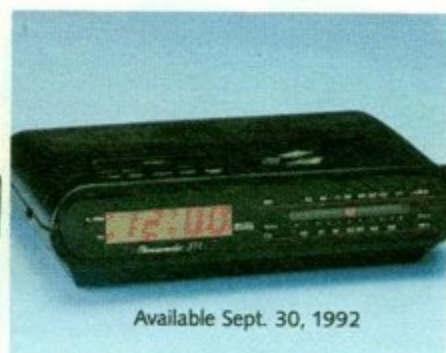

Available Sept. 30, 1992

New! Super-Slim Design

Chronomatic-277. Adjustable alarm volume, alarm "on" and p.m. LEDs, 0.6" display with hi/lo dimmer, sleep/snooze. 3" speaker. 2 x 8 3/4 x 5 3/8". **12-1585 24.95**



New! Wake Up to Value

Chronomatic-275. Small size, small price, big performance. Has top-mounted snooze and sleep controls, 0.6" LED display, 2 1/4" speaker. 2 1/8 x 7 5/8 x 4 7/8". **12-1583 15.95**

Novelty radios/cassettes and Weatheradio® receivers

Introduced in 1968 by Radio Shack, the Weatheradio® is your 24-hour "hotline" to National Weather Service forecasts, storm warnings and traveler's advisories broadcast on commercial-free VHF stations in over 350 cities. Each Weatheradio is crystal-controlled for drift-free reception and has up to 50-mile receiving range. Over one million sold to satisfied customers!



(1) **Archer Road Patrol®**. AM/FM bicycle radio with horn and 3" safety reflector. 3½ x 5¼ x 3⅞". Requires 3 "C" batteries. 12-200 24.95

(2) **Realistic® MTA-15**. Classic AM/FM table radio with terrific sound. 6 x 10¾ x 4". 12-695 39.95

(3) **1934 Atwater Kent Replica**. AM/FM radio with side-mounted monaural cassette player. 12¾ x 10¼ x 8¼". (TSP) 12-697 69.95

(4) **Water Resistant**. AM/FM for patio, pool. Wall bracket. 5 x 5¼ x 1¾". Requires 4 "AA" batteries. 12-784 .. 14.95

(5) **NEW! SPORTS MATE® 3-in-1 Portable**. It's an AM/FM radio, lantern and emergency blinker. 5½ x 4⅝ x 4¼". Requires 4 "D" batteries. 12-206, 19.95

(6) **Waterbuddy™ AM/FM Radio**. It floats! FM-AFC, rotary tuning. Indoor/outdoor use. 8" diameter. Requires 4 "AA" batteries. 12-204 19.95



(1) **Pocket Weatheradio Alert**. Great for travelers. Gives you an advance warning of storms anywhere U.S. Government Weather Service is available. Station activates built-in alarm. 5¼ x 2¾ x 7/8". Requires 3 "AA" batteries. 12-143 29.95

(2) **NEW! Mini Pocket Weatheradio**. Compact size—easy to carry in pocket or purse. Ideal for hunters, boaters, golfers and hikers. Rotary volume control. 4¼ x 2⅝ x 7/8". Requires 9V battery. 12-242 19.95

(3) **Desktop Weatheradio**. Has one-touch on/off button, power "on" LED and fold-down telescoping antenna. 1⅞ x 5¾ x 3½". Requires 9V battery or AC adapter. 12-241 21.95

(4) **Desktop Weatheradio Alert**. Weather alarm tone alerts you of dangerous conditions. One-touch on/off button for continuous forecasts. Alert test/standby with LED indicator. Fold-down telescoping antenna. 2 x 6 x 4⅞". UL listed AC. Backup requires 9V battery. 12-240 39.95



(1) **CTR-86 Recorder/Radio**. Enjoy cassettes and AM stations on-the-go! Features built-in microphone for "live" recordings. Earphone jack. 7¾ x 8¾ x 2¾". Requires 4 "C" batteries or AC or DC adapter. 14-852 29.95

(2) **CTR-63 Recorder**. On-top controls. Auto-stop. Built-in microphone. 8⅞ x 6⅞ x 2¾". Requires 4 "C" batteries or AC adapter. 14-846 27.95

(3) **CTP-70 Sing-Along Player**. With detachable mike. Auto-stop, separate tape/mike volume controls. 8¾ x 7¾ x 2⅝". Requires 4 "C" batteries or AC adapter. 14-851 23.95

(4) **Melody-Mate™ Stereo**. Colorful, musical fun! Child's first AM/FM stereo cassette player. Includes headphones and belt clip. 5⅜ x 4⅝ x 2". Requires 2 "AA" batteries. 14-853 34.95

(5) **CTR-81 Stereo Cassette**. With 2½" speakers and in-ear stereo headphones. 4½ x 11¾ x 3⅜". Requires 4 "C" batteries or AC adapter. 14-840 ... 39.95

(6) **NEW! Karaoke Music System**. Sing along to your favorite cassettes! Features rotary mike/tape balance, volume, music/voice mixer and echo controls. Jack for adding mike. Requires 4 "AA" batteries or AC adapter. 14-856 .. 39.95

STEREO-MATE® personal radios for fun on the run

When it's time to buy a new radio, trust Radio Shack and the STEREO-MATE name! Our proven quality, performance and dependability have made us #1 in U.S. retail sales of radios. With dozens of models to choose from, you'll find the right radio at the right price. And with nearly 7000 locations nationwide, we'll be there when you need us. When it comes to radios, America comes to Radio Shack. Satisfaction guaranteed.



- (1) **All-Weather AM/FM Stereo.** Really rugged—take it along on your next adventure! Sealed with neoprene gaskets to shrug off sand, water spray and dust. Has belt clip. Requires "AA" battery and headphones. 12-142 17.95
- (2) **AM/FM STEREO-MATE With Speaker.** Listen with built-in 1½" mono speaker, or add stereo headphones for privacy and FM stereo sound. Requires 2 "AAA" batteries. 12-132 19.95
- (3) **NEW! AM/FM STEREO-MATE®.** Ideal for

- exercising—clips to waistband. Lightweight AM/FM stereo with in-ear phones and belt clip. Requires 2 "AAA" batteries. 12-182 19.95
- (4) **STEREO-MATE With Speaker.** Add headphones for AM/FM stereo or use built-in mono speaker. Requires 2 "AAA" batteries. 12-179 24.95
- (5) **Super-Thin AM/FM STEREO-MATE.** Fits easily in shirt pocket—just 9/16" thin! Requires 2 "AAA" batteries and headphones. 12-189 24.95



Lightweight STEREO-MATE Headset Radios

- (1) **SPORTS MATE® Headband FM Stereo Receiver.** Withstands wet weather conditions. With head and arm bands, in-ear phones. Requires "AAA" battery. 12-138 19.95
- (2) **Budget AM/FM Stereo.** Slide-action volume control, rotary tuning control, built-in FM-AFC to prevent drift. Requires 2 "AAA" batteries. 12-145 24.95
- (3) **Fold-Up FM Stereo.** Folding headset allows quick, easy storage in pocket or purse—weighs just slightly over two ounces. Requires "AAA" battery. 12-144 ... 29.95

- (4) **AM/FM Stereo.** Weighs just six ounces with batteries! FM-AFC circuit, AM loopstick and FM wire-loop antennas for best reception. Balance control. Low-power-drain circuit for extra-long battery life. Requires 2 "AAA" batteries. 12-146 34.95
- (5) **Folding Micro AM/FM Stereo.** Ideal for working out or just relaxing. Weighs about two ounces with batteries installed, yet delivers superior stereo sound. Adjustable headband. Fold-up design saves space. Requires "AAA" battery. 12-128 39.95

- (6) **Fold-Up Digital-Tuning AM/FM Stereo.** Big performance in a little package—our finest headset stereo! Digital-synthesized circuit locks-in stations precisely, and six FM and six AM memory presets let you find your favorite stations at the touch of a button. Easy-to-read LCD frequency display clearly shows you which station you're tuned to. Features bass-boost and balance controls for customized stereo sound. Folds for easy storage. Built-in AM antenna and FM wire antenna for best reception from all stations. Adjustable headband. Requires 2 "AAA" batteries. (TSP) 12-171 69.95



AM/FM Stereo with Digital Tuner, 10 Presets

Realistic STEREO-MATE. A superb shirt-pocket stereo—just 7/8" thin! Pushbutton tuning—scans up and down, locks in stations. Preset memory stores up to five FM and five AM stations. Has LCD band/frequency/memory preset number display. With removable belt clip. Requires 2 "AAA" batteries and stereo headphones. 12-170 .. 49.95



Digital AM/FM Stereo Tuner with 19 Presets

Optimus® STEREO-MATE. A great performer! Auto-scans all 19 preset stations at the touch of a button. With "lock" switch to prevent accidental changing of settings. Automatically shuts off after 60 minutes to help conserve batteries. LCD display, belt clip. Requires 2 "AAA" batteries and stereo headphones. (TSP) 12-147 59.95



Pocket AM/FM Stereo With VHF-TV Sound

PortaVision®. Keep up with the big game—even if you can't get to a TV. Digital tuning locks in FM and AM stereo plus TV sound on channels 2-13. Pushbutton tuning with 19 presets. LCD display. 60-minute auto-shutoff saves batteries. Built-in monaural speaker and stereo headphone jack. Requires 2 "AA" batteries. (TSP) 12-174, 69.95

**Cassette players...
we sell more than
any store in the USA**

F.Y.I.

AUTO-REVERSE. Automatically reverses direction of a tape during playback, letting you listen to both sides without flipping the tape.

AUTO-STOP. Senses tension on the supply wheel and shuts off mechanism to protect tapes and reduce wear on the tape transport.

BASS BOOST/EXTENSION. Enhances low-frequency response for richer, fuller bass.

DIGITAL-SYNTHESIZED TUNING. Locks your selected frequency to a precise quartz-crystal reference to improve reception and eliminate drift to other frequencies.

DOLBY NR. Noise reduction system that dramatically reduces tape hiss for superior sound. Also increases dynamic range.

FM STEREO/MONO SWITCH. Lets you switch from stereo to monaural mode to improve reception of weak or distant FM stations.



(1) **NEW!** Realistic SCP-18. Separate left/right volume controls. Requires 2 "AA" batteries or DC adapter. 14-1065 19.95

(2) **NEW!** Realistic SCP-21. Separate volume controls and 3-band EQ. Requires 2 "AA" batteries or AC or DC adapter. 14-1064 .. 29.95

(3) Realistic SCP-41 Auto-Reverse. Bass boost adds "punch" to music. Requires 2 "AA" batteries or AC or DC adapter. Was \$49.95 in '92 Catalog. 14-1079 **New Low Price!** 39.95

(4) Realistic SCP-44 Auto-Reverse, Dolby NR. Loaded with features including Dolby™ NR and bass boost for full, clean sound even at low volumes. Cassette has metal-CrO₂/normal tape selector for best sound from all tape types. 14-1083 49.95

(5) **NEW!** Realistic SCP-49 Auto-Reverse. With Dolby NR and bass boost for the best possible sound. Requires 2 "AA" batteries or AC or DC adapter. (TSP) 14-1089 ... 59.95

We Have a Personal Stereo for Everyone



(1) **NEW!** Realistic SCP-47. Separate left/right volume controls, stereo/mono switch, belt clip. Requires 2 "AA" batteries or DC adapter. 14-1087 29.95

(2) Realistic SCP-37. Enjoy your favorite music anytime! Auto-stop conserves batteries and tape. Requires 2 "AA" batteries or AC or DC adapter. 14-1073 39.95

(3) Realistic SCP-42. Auto-reverse and bass boost. Requires 2 "AA" batteries or AC or DC adapter. 14-1081 49.95

(4) Realistic SCP-45. Most-wanted features—Dolby B, tape selector and bass boost for great sound. Requires 2 "AA" batteries or AC or DC adapter. (TSP) 14-1084 79.95

(5) **NEW!** Realistic SCP-50. Loaded with features! Auto-reverse, Dolby NR, digital tuning with 10 presets, tape selector, bass boost, more. Requires 2 "AA" batteries or AC or DC adapter. (TSP) 14-1090 99.95

(6) **Optimus® SCP-43 Auto-Reverse.** Our finest—awesome digital stereo-to-go. And it's rechargeable—you'll never have to worry about batteries! Digital tuning with 10 memory presets, auto search and LCD display. Dolby B, tape selector, bass boost. Includes in-ear phones. With rechargeable battery and UL listed AC adapter/charger. (TSP) 14-1082 199.95

Model Cat. No.	Auto Reverse	Dolby NR	Bass Boost/ Extension	AM/FM Tuner	FM Stereo/ Mono	Digital Tuning	LCD Display	Tape Selector	3-Band EQ	Left/Right Volume	Belt Clip	Rechargeable	Clock
SCP-18 14-1065										✓	✓		
SCP-41 14-1079	✓		✓							✓	✓		
SCP-49 14-1089	✓	✓	✓	✓	✓			✓			✓		
SCP-21 14-1064									✓	✓	✓		
SCP-44 14-1083	✓	✓	✓					✓			✓		
SCP-42 14-1081	✓		✓	✓	✓					✓	✓		
SCP-37 14-1073				✓	✓					✓	✓		
SCP-47 14-1087				✓	✓					✓	✓		
SCP-45 14-1084	✓	✓	✓	✓				✓			✓		
SCP-50 14-1090	✓	✓	✓	✓	✓	✓	✓	✓			✓		✓
SCP-43 14-1082	✓	✓	✓	✓	✓	✓	✓	✓				✓	✓

Portable cassette recorders for home, school and office

Radio Shack has the widest selection of cassette recorders anywhere! And our knowledgeable sales professionals will help you choose the one just right for you—whatever your need or budget. Whether you're recording classroom lectures, conferences, personal memos, "talking letters" or dictation, the choice to make is Realistic—famous for value, quality and long-lasting reliability.

Here's a Realistic sound tip. For easy, "error-free" recordings, consider these features: voice actuation to save tape by recording only when someone is talking, auto-level for perfect-volume recordings every time, and cue/review to hear the tape in fast-forward and rewind so you can find selections quickly.



- (1) **NEW! Realistic® CTR-24 Auto-Level.** Our lowest priced portable! Compact size, auto-stop, earphone jack. Wrist strap. $4\frac{3}{4} \times 3\frac{3}{8} \times 1\frac{3}{8}$ ". Requires 2 "AA" batteries or AC or DC adapter. 14-1102 29.95
- (2) **Realistic CTR-22 Voice Actuation.** Our lowest-priced hands-free recorder. Has auto-level, tape counter, earphone jack. $3\frac{7}{16} \times 5\frac{3}{16} \times 1\frac{1}{2}$ ". Requires 2 "AA" batteries or AC adapter. 14-1100, 39.95
- (3) **NEW! Realistic CTR-76 Voice Actuation.** Auto-level makes recording a breeze. Cue/review and tape counter to help find selections. Pause. Earphone, remote-mike jacks. $4 \times 7 \times 1\frac{5}{8}$ ". Requires 4 "AA" batteries or AC or DC adapter. 14-1156 49.95

- (4) **Miniset®-20 Voice Actuation and Cue/Review.** Convenient compact size. Auto-stop, battery LED, tape counter. With earphone. Jack for remote mike. $4\frac{1}{2} \times 3\frac{1}{4} \times 1\frac{1}{2}$ ". Requires 2 "AA" batteries or AC or DC adapter. 14-1055 59.95
- (5) **Realistic VSC-2001 Variable Speech Control™ and Voice Actuation.** Lets you vary speed and pitch for faster, yet normal-sounding playback with any standard cassette. Ideal for reviewing lengthy lectures or speeches and allows typists to transcribe dictation at top speed. Voice actuation and auto-level team-up for hands-free recording. Cue/review, tape counter, built-in mike. $4\frac{1}{16} \times 6\frac{9}{16} \times 1\frac{5}{8}$ ". Requires 4 "AA" batteries or AC or DC adapter. 14-1058 79.95



Check Out Our Selection of Desktop Cassette Recorders

- (1) **Realistic CTR-62 With Cue/Review.** Also features auto-level to make recording at the correct volume guess-free, auto-stop to protect tapes and a built-in condenser microphone, plus an external mike jack. Comes with earphone for private listening. $1\frac{7}{8} \times 5\frac{5}{8} \times 9\frac{3}{4}$ ". Requires 4 "C" batteries or AC or DC adapter. 14-1150 29.95
- (2) **Realistic CTR-66 AC/Battery.** Easy to operate with auto-level, plus cue/review for audible search in fast-forward and rewind. Features earphone and remote-mike jacks. $1\frac{7}{8} \times 5\frac{5}{8} \times 9\frac{3}{4}$ ". UL listed AC (or 4 "C" batteries or DC adapter, extra). 14-1151 39.95
- (3) **Realistic CTR-73 With Tone Control.** A super "notetaker." Auto-stop saves batteries and protects your tapes. Has built-in mike, auto-level, cue/review, tape counter and record/battery LED. External mike jack. $1\frac{3}{4} \times 5\frac{1}{2} \times 10\frac{1}{2}$ ". UL listed AC (or 4 "C" batteries or DC adapter, extra). 14-1053 49.95
- (4) **NEW! Realistic CTR-67 Voice Actuation.** Includes the most-wanted features: auto-level and cue/review. With earphone and remote-mike jacks. $1\frac{7}{8} \times 5\frac{5}{8} \times 9\frac{3}{4}$ ". UL listed AC (or 4 "C" batteries or DC adapter, extra). 14-1152 49.95
- (5) **Realistic CTR-69 Voice Actuation.** Switch auto-level on for consistent volume on speech recordings or off for wider dynamic range on music. Cue/review and tape counter make it easy to find selections. Cue/review also lets you listen to a recorded passage over and over. Also features LED recording meter and auto-stop. Earphone and remote-mike jacks. $2\frac{1}{8} \times 9\frac{11}{16} \times 6\frac{3}{4}$ ". UL listed AC (or 4 "C" batteries or DC adapter, extra). 14-1154 69.95



- (1) **Realistic Micro-14.** Auto-level, cue/review, 2 speeds, auto-stop, tape counter. Earphone, remote-mike jacks. 4⁷/₈ × 2¹/₂ × 1¹/₁₆". Requires 2 "AA" batts. or AC or DC adapter. **14-1175, 39.95**
- (2) **NEW! Realistic Micro-16.** Same as Micro-14, but with voice actuation. **14-1176 49.95**
- (3) **Realistic Micro-27 With Fast-Play Mode.** Increase playback speed, keep voices understandable. Two speeds. With case, earphone. 4³/₄ × 2¹/₈ × 1⁵/₁₆". Requires 2 "AA" batteries or AC or

- DC adapter. **14-1044 99.95**
- (4) **Realistic Micro-26—Our Finest With Voice Actuation.** Remote-mike jack. With earphone, carry case. 4-⁵/₁₆ × 2¹/₁₆ × 5⁵/₈". Requires 2 "AAA" batteries or AC or DC adapter. **14-1043 149.95**
- (5) **NEW! Realistic Micro-51 Desktop With Voice Actuation.** Earphone. 1¹/₁₆ × 6¹¹/₁₆ × 4³/₈". Requires 2 "AA" batteries or AC or DC adapter. **14-1190, 59.95**

Micro recorders, tape and handy accessories

Microcassette Cleaner Kit. Restores voice clarity. With cleaning cassette, probe, mirror and solution. **44-1168 5.99**

Microcassette Head Cleaner. Loads like a cassette to clean tape path. Nonabrasive. Helps restore clarity. **44-1166 2.99**

Quality Mini and Microcassettes

Type	Total Time	Cat. No.	Each	3-Up
MC-60	Up to two hours	44-640	3.49	3.00
MC-90	Up to three hours	44-644	6.95	5.98

Mini 30. Up to 30 minutes total recording time.
44-633. 1-9 3.29 10-Up 2.79



- (1) **Realistic SCR-42 AM/FM Digital Tuning, Auto Reverse.** Ten memory presets, Dolby NR, separate bass/treble, tuning/time LCD. With stereo mike, in-ear phones and belt clip. 4¹/₂ × 3¹/₄ × 1¹/₄". Requires 2 "AA" batteries or AC adapter. **14-1085 159.95**
- (2) **Realistic SCR-26 AM/FM Dolby B NR Cassette.** Auto-reverse, metal-CrO₂/normal selector, bass boost, separate bass/treble controls, auto-level. With stereo mike, in-ear stereo phones, removable belt clip. 4⁵/₈ × 3¹/₄ × 1¹/₂". Requires 2 "AA" batteries or AC or DC adapter. Was \$139.95 in 1992 Catalog. **14-1078 New Low Price! 99.95**
- (3) **Realistic SCR-51.** Record in stereo with the built-in mikes! Stereo headphone jack, mono speaker, auto-level, left/right volume controls, external mike jacks. 5¹/₈ × 3⁹/₁₆ × 1¹/₂". Requires 2 "AA" batteries or AC or DC adapter. **14-1068 79.95**

Power Adapters for Portable Recorders, Personal Stereo

Stop wasting batteries and start saving money! Convert your portable to two or three-way power with these adapters. They will power your portable tape recorder

from 120VAC house current or 12VDC vehicle power. Especially useful for reviewing lengthy recordings at home or out on the road. Buy one for your home and car!

Cat. No.	AC	Each	DC	Each
14-0529	*	*	270-1534	5.79
14-0532	*	*	*	*
14-0701	*	*	270-1562	14.95
14-0702	*	*	14-844	6.95
14-0705	*	*	270-1562	14.95
14-0752	*	*	14-844	6.99
14-0755	*	*	14-844	6.99
14-0757	*	*	270-1562	14.95
14-0758	*	*	14-844	6.99
14-0759	*	*	270-1562	14.95
14-0760	*	*	14-844	6.99
14-0762	*	*	14-844	6.99

Cat. No.	AC	Each	DC	Each
14-0766	273-1455	7.95	14-844	6.99
14-0767	273-1650	12.95	14-844	6.99
14-0769	*	*	270-1533	3.79
14-0840	273-1650	12.95	270-1560	11.95
14-0846	273-1454	7.95	14-844	6.99
14-0851	273-1454	7.95	14-844	6.99
14-0852	273-1454	7.95	14-844	6.99
14-0853	*	*	*	*
14-0856	273-1651	10.95	270-1562	14.95
14-1043	273-1654	13.95	270-1560	11.95
14-1044	273-1435	6.95	270-1560	11.95
14-1053	*	*	14-844	6.99

Cat. No.	AC	Each	DC	Each
14-1055	273-1654	13.95	270-1560	11.95
14-1058	273-1454	7.95	270-1560	11.95
14-1065	273-1456	6.95	270-1560	11.95
14-1068	273-1654	13.95	270-1560	11.95
14-1073	273-1654	13.95	270-1560	11.95
14-1078	273-1654	13.95	270-1560	11.95
14-1079	273-1654	13.95	270-1560	11.95
14-1081	273-1654	13.95	270-1560	11.95
14-1082	*	*	270-1560	11.95
14-1083	273-1654	13.95	270-1560	11.95
14-1084	273-1654	13.95	270-1560	11.95
14-1085	273-1654	13.95	270-1560	11.95

Cat. No.	AC	Each	DC	Each
14-1087	273-1654	13.95	270-1560	11.95
14-1089	273-1654	13.95	270-1560	11.95
14-1090	273-1456	6.95	270-1560	11.95
14-1100	273-1456	6.95	270-1560	11.95
14-1102	273-1456	6.95	270-1560	11.95
14-1150	273-1454	7.95	14-844	6.99
14-1151	*	*	14-844	6.99
14-1152	273-1454	7.95	14-844	6.95
14-1154	*	*	14-844	6.99
14-1156	273-1454	7.95	14-844	6.95
14-1175	273-1435	6.95	270-1560	11.95
14-1176	273-1435	6.95	270-1560	11.95
14-1190	273-1435	6.95	270-1560	11.95

*Not required, AC power cord included



Realistic SCR-41. Enjoy uninterrupted listening thanks to auto-reverse, plus enhanced sound from Stereo-Wide™ system. High-speed synchro-dubbing. Three-band equalizer. UL listed AC (or 6 "C" batteries or DC adapter, extra). (TSP) 14-760 119.95

NEW! Realistic SCR-43. Digital tuning—six AM and six FM presets let you store favorite stations for instant recall. LCD digital display. Has high-speed dubbing, Stereo-Wide circuit, 3-band equalizer. UL listed AC (or 10 "D" batteries, extra). (TSP) 14-769 119.95

NEW! Realistic SCR-45. Bass boost adds that extra "punch", and Stereo-Wide expands the stereo image. You can tailor sound even more with the 3-band equalizer. Has high-speed dubbing, continuous play. UL listed AC (or 6 "D" batteries, extra). (TSP) 14-701 99.95

Superb sound to carry around...Realistic®



COMPACT
disc
DIGITAL AUDIO

With Programmable CD and Dual Cassettes

NEW! Realistic CD-3307. Top-loading CD player has 16-track memory, repeat, and LCD track display. Synchro-start makes CD-to-tape dubbing and tape duplication easy. Copies tapes at normal or high speed, plays two tapes in sequence and records from CD, FM stereo, AM or "live" with built-in mike. UL listed AC (or 8 "D" batteries or DC adapter, extra). (TSP) 14-532 199.95

With Dual Cassettes, Subwoofer and Dolby™ NR

Realistic SCR-39. Take along powerful portable stereo! Crank up pulsating bass with the dynamic bi-amplified subwoofer. Record from FM stereo, AM, external sources or add mikes for "live" recordings. High-speed synchro-start dubbing. Dolby NR cuts "hiss" and extends dynamic range. 3-band graphic equalizer. UL listed AC (or 6 "D" batteries, extra). (TSP) 14-757 179.95



Realistic SCR-24. Dual cassettes, Stereo-Wide circuit, high-speed dubbing. UL listed AC (or 6 "C" batteries or DC adapter, extra). (TSP) 14-762 79.95



NEW! Realistic SCR-48. Our lowest priced high-speed dubbing cassette. Continuous play, built-in mike. UL listed AC (or 4 "C" batteries, extra). (TSP) 14-705 69.95

Model/ Cat. No.	CD	High-Speed Dubbing Cassette	Auto Reverse	Dolby NR	Digital Tuning	Stereo Wide	Bass Boost/ Extension	Sub Woofer	Stereo	EQ	Built-In Mike
SCR-41 14-760		✓	✓			✓			✓		✓
SCR-43 14-769		✓			✓				✓	✓	✓
SCR-45 14-701		✓				✓	✓		✓	✓	✓
CD-3307 14-532	✓	✓							✓		✓
SCR-39 14-757		✓		✓				✓	✓	✓	
SCR-24 14-762		✓				✓			✓		✓
SCR-48 14-705		✓							✓		✓
SCR-20 14-755									✓		✓
SCR-40 14-759									✓		✓
SCR-34 14-752									✓		✓
CD-3304 14-529	✓								✓		✓
SCR-46 14-702			✓				✓		✓		✓
CTR-83 14-758											✓
CTR-84 14-766											✓
SCR-37 14-767									✓		✓



Realistic SCR-20. Enjoy stereo cassettes plus your favorite FM stereo and AM stations 'most anywhere you go. Records directly off the air or "live" with built-in mike. Auto-level for best recordings. UL listed AC (or 6 "C" batteries or DC adapter, extra). (TSP) 14-755 69.95

Realistic SCR-40. Listen with the ultralight in-ear phones or share the music through the speakers. Two-position tone switch ensures best sound on voice or music. Fold-away carry handle. UL listed AC (or 5 "C" batteries or DC adapter, extra). (TSP) 14-759 59.95

Realistic SCR-34. Big sound from a 2 1/2" -slim portable. Easy to take, too, thanks to the included shoulder strap. Auto-level recording, end-of-tape auto-stop, high/low tone switch. UL listed AC (or 6 "AA" batteries or DC adapter, extra). 14-752 49.95

Values in AM/FM stereo portable cassettes



COMPACT
disc
DIGITAL AUDIO

With CD-to-Cassette Synchro-Dubbing

Realistic CD-3304. Enjoy digital stereo clarity at home or on the go! CD-to-tape dubbing is a snap with synchro-start. Records from FM stereo, AM or "live" with built-in mike, too. Auto-level assures perfect-volume recordings. Auto-stop protects tapes. UL listed AC (or 8 "D" batteries or DC adapter, extra). Was \$199.95 in 1992 Catalog. (TSP) 14-529 **New Low Price! 169.95**

With Auto-Reverse and Extended Bass

NEW! Realistic SCR-46. Enjoy solid bass response you'd expect only from a home stereo. Bass extender brings extra impact to any music. Auto-reverse adds to the enjoyment—listen to both sides without flipping the tape. Record from FM stereo, AM or "live" with built-in mike. FM stereo LED indicator. UL listed AC (or 6 "C" batteries, extra). (TSP) 14-702 79.95



Monaural AM/FM Cassette Portable Player/Recorders

Realistic CTR-83. A terrific portable entertainment value—plays on home AC, batteries or vehicle DC with optional adapter. Auto-stop protects tapes and saves batteries. Big 3 1/2" speaker delivers excellent sound. Built-in condenser microphone. UL listed AC (or 4 "C" batteries or DC adapter, extra). 14-758 39.95

Realistic CTR-84. Delivers excellent sound you'll enjoy at home, by the pool, in the park—you name it. Records direct from FM, AM, or "live" with the built-in electret condenser microphone. Plays on AC, batteries or vehicle DC. UL listed AC (or 4 "C" batteries or DC adapter, extra). 14-766 34.95

Realistic SCR-37. Compact size, large stereo sound! Carry this versatile performer along for listening to your favorite stereo cassettes, FM stereo or AM stations. Record directly off the air or "live" with the built-in mike. Auto-stop protects tapes and saves batteries. High/low tone switch adjusts sound for voice or music. FM stereo LED indicator. Requires 4 "C" batteries or AC or DC adapter. 14-767 39.95

Adapters are available to convert most of these portables to 3-way power—batteries, AC, and DC—see page 37.
SUPERTAPE® audio cassettes always give you best recording results—see page 61.

Stereo music systems with CD players and dual cassettes

F.Y.I.

Look for these features on Realistic and Optimus stereo music systems

DIGITAL TUNING. Locks selected frequency to a precise quartz-crystal reference to improve reception and eliminate drift.

SYNCHRO-START DUBBING. Cassette feature that starts both tapes simultaneously at the touch of a button for easy copying.

DOLBY™ B NR. A noise reduction system that works during tape recording and playback to cut hiss for improved sound.

EQUALIZER. Tone controls for selected frequency bands. Use to adjust sound to personal taste, or to compensate for poor recordings or unusual room acoustics.

E-BASS BUTTON. Extends dynamic range by increasing output of low frequencies.

Music systems do not include recordings shown



100 watts per channel, minimum rms into 8 ohms from 40-20,000 Hz, with no more than 0.9% total harmonic distortion

100 Watts, CD Player, Digital Tuner, Turntable, EQ, 12" Woofers

NEW! Optimus® System 1030. Sensational high-power stereo sound and convenient remote control. Use the remote to operate the 16-track programmable CD player, select from 12 FM and six AM station presets, tune up/down manually and adjust volume/mute from your chair. High-speed dubbing dual-cassette deck has Dolby™ B NR to improve

sound on playback, plus metal/normal tape switch. Five-band graphic equalizer lets you shape sound to your taste. Two-speed turntable with cartridge. Two aux inputs, 1/4" headphone and mike jacks. Speakers each have a 12" woofer, 4" midrange and 3" tweeter in 36"-high wood enclosure. Rack with glass door and casters. (TSP) 13-1249 749.95



120 watts per channel, minimum rms into 8 ohms from 40-20,000 Hz, with no more than 0.9% total harmonic distortion

120 Watts, CD Changer, Surround Sound, 15" Woofers

NEW! Optimus System 1230. Our finest system, with surround-sound output for concert-like realism. Five-disc front-loading carousel holds your favorite CDs for hours of uninterrupted listening. Remote controls CD player, the digital tuner with 12 FM/six AM

presets and volume up/down/mute. High-speed dubbing deck with Dolby B NR and synchro-start. Five-band EQ, 2-speed turntable. 36"-high speakers with 15" woofers, 4" midranges and 3" tweeters. Rack with glass door and casters. (TSP) 13-1250 899.95

CD Player, EQ, Digital Tuner

Realistic® System 320. You get a 20-track programmable CD player, digital tuner with 20 AM/FM stereo presets, high-speed synchro-dubbing, 5-band equalizer, 2-speed turntable, remote. 33 1/8"-high 2-way speakers. (TSP) 13-1238 399.95



AM/FM Stereo With Digital Tuner

Realistic System 120. Has synchro-start cassette with auto-stop and auto-level. Copies personal tapes and records directly from FM stereo, AM or 2-speed turntable. Tuner has FM-AFC, FM stereo LED and extended AM-band coverage. 27 1/4"-high speakers. (TSP) 13-1240 199.95



Without CD



50 watts per channel, minimum rms into 8 ohms from 60-20,000 Hz, with no more than 0.9% total harmonic distortion

4-Disc CD Carousel, High-Speed Dubbing

NEW! Optimus System 700. CD changer has 8-times oversampling and 32-selection memory. You can even change up to three CDs while listening to another. Dual cassette with full-logic auto-reverse and synchro-dubbing. Digital tuner has 36 AM/FM stereo presets. Two-speed turntable, 5-band graphic equalizer, E-bass button, 3-way speakers with 6 1/2" woofers, remote. (TSP)

13-1248 699.95



40 watts per channel, minimum rms into 8 ohms from 60-20,000 Hz, with no more than 0.5% total harmonic distortion

3-Disc CD Changer, Surround Output

NEW! Optimus System 710. CD carousel lets you change discs while listening to another, and features 20-track memory plus dual D/A converters. Has digital tuner with 30 AM/FM presets, 7-band EQ with five preset/five programmable modes. Auto-reverse and high-speed synchro-dubbing. Three-way speakers with 6 1/2" woofers, remote. (TSP)

13-1253 699.95



25 watts per channel, minimum rms into 8 ohms from 60-20,000 Hz, with no more than 0.9% total harmonic distortion

CD-to-Tape Dubbing and Surround Output

NEW! Optimus System 600. Features CD player with 4-times oversampling and 20-selection memory, digital tuner with 19 AM/FM presets, and high-speed dubbing cassette with dual auto-reverse and Dolby NR. Six EQ presets by music styles, plus 7-band spectrum analyzer. Two-way speakers with 6 1/4" woofers, remote. (TSP)

13-1247 599.95



15 watts per channel, minimum rms into 8 ohms from 60-20,000 Hz, with no more than 0.9% total harmonic distortion

6-Disc CD Changer, 20 FM/10 AM Presets

NEW! Optimus System 620. Load the magazine-type disc changer and enjoy hours of pure digital sound! Changer has 4-times oversampling and 20-track memory. Digital tuner has auto-scan. High-speed dubbing cassette with auto-reverse on playback and Dolby B NR. E-bass button, 5-band EQ, 3-way speakers with 4 3/4" woofers, remote. (TSP)

13-1251 579.95

**The hottest thing
in audio—mini
systems with CD**



NEW! Realistic Modulaire®-580. Has 20-memory CD player with random-play, digital tuner with 12 FM/six AM presets, high-speed synchro-dubbing deck, EQ, 2-way speakers and remote. (TSP) 13-1252 349.95



Modulaire-570. Features programmable CD player with 15-track memory, digital tuner with 12 FM/six AM presets, high-speed dubbing deck, EQ, 2-way speakers and remote. (TSP) 13-1246 299.95



Modulaire-560. CD player with 16-track memory, digital tuner with 12 FM/six AM presets, high-speed dubbing deck, 2-speed turntable, 3-band EQ, 2-way speakers and remote. (TSP) 13-1242 299.95



Without CD

Realistic Clarinette®-125. Synchro-start dual cassette copies personal tapes and plays two in sequence. AM/FM stereo, turntable, headphone jack, 15" -high speakers. (TSP) 13-1245 119.95.

OPTIMUS...LIVE IN CONCERT!®

Optimus® audio equipment is the culmination of our more than 70-year tradition of electronics excellence. Every Optimus component is meticulously designed and quality crafted, utilizing superior engineering and manufacturing

processes. And each is backed by the tightest quality-control program in the consumer electronics industry. For a masterful blend of technology, reliability and elegance, always choose Optimus brand audio components.



Main amplifier: 100 watts per channel, minimum rms into 8 ohms from 20-20,000 Hz, with no more than 0.05% total harmonic distortion
Surround amplifier: 25 watts total, minimum rms into 8 ohms at 1 kHz, with no more than 0.5% THD

NEW! Optimus STAV-3250. Wrap yourself in the performance with this superb 100-watt receiver. Dolby Surround™ brings 3-dimensional "movie theater" presence into your home. For non-Dolby material, a Hall mode simulates the depth and realism of a concert auditorium, and Stadium mode brings you all the excitement of sports events. Tailor sound to your taste with the 5-band equalizer and spectrum display. You get 30 AM/FM memory presets with station-name ID, a motorized volume control and search and scan tuning—all controlled by a full-function remote. With front-panel A/V input, A/V dubbing controls and a full array of inputs. Remote requires 2 "AA" batteries. (TSP) 31-3021 449.95
Dolby™ Laboratories Licensing Corp.

Stereo Receivers to Fit Your Budget

(1) **Optimus STA-2170.** Enjoy feather-touch AM/FM tuning and one-touch memory storage of 24 stations. Matrix circuit delivers surround-sound effect from any source—just add rear speakers. Dual 5-step LED power meters. Loudness, FM mono/mute and tape monitor controls, rotary bass and treble controls. Inputs: CD/aux, magnetic phono, tape, video sound source. Was \$339.95 in 1992 Catalog. (TSP) 31-3013 **New Low Price! 299.95**

(2) **NEW! Optimus STA-900.** Features 30 memory presets, search tuning and memory scan, plus a 5-band graphic equalizer and 4-speaker surround-sound control. Loudness, FM mono/mute controls. Inputs: CD/aux, magnetic phono, tape deck, video sound source. Remote requires 2 "AA" batteries. (TSP) 31-2120 **249.95**

(3) **NEW! Optimus STA-825.** Precise digital tuning and 30 memory presets put stations at your fingertips. FM mono and muting controls, separate bass and treble controls, loudness. Convenient tape monitoring control. Inputs: turntable, tape deck, two auxiliary audio sources. Remote requires 2 "AA" batteries. (TSP) 31-2105 **199.95**

(4) **Optimus STA-795.** Drift-free digital tuning, feather-touch controls, 18-station memory. Separate bass and treble, loudness and tape monitor controls. 5-step LED power meter. Inputs: CD/aux, magnetic phono, tape deck, video sound source. Was \$199.95 in 1992 Catalog. (TSP) 31-2101 **New Low Price! 179.95**

(5) **Optimus STA-300.** This compact-sized receiver features drift-free digital tuning, feather-touch controls and one-touch memory storage of 18 stations. Also has multifunction LCD display, separate bass and treble controls, loudness control. Inputs: CD/aux, magnetic phono, tape deck. (TSP) 31-1991 **139.95**

(1) 100 watts per channel, minimum rms into 8 ohms from 20-20,000 Hz, with no more than 0.3% total harmonic distortion

(2) 70 watts per channel, minimum rms into 8 ohms from 20-20,000 Hz, with no more than 0.5% total harmonic distortion

(3) 50 watts per channel, minimum rms into 8 ohms from 40-20,000 Hz, with no more than 0.5% total harmonic distortion

(4) 50 watts per channel, minimum rms into 8 ohms from 40-20,000 Hz, with no more than 0.5% total harmonic distortion

(5) 15 watts per channel, minimum rms into 8 ohms from 40-20,000 Hz, with no more than 0.5% total harmonic distortion



NEW! Optimus STAV-3160. This 100-watt receiver with Dolby Pro•Logic can bring you surround sound superior to some theaters. Just connect left and right front-channel speakers (like conventional stereo) plus a pair of rear-channel speakers for exciting Dolby Surround. Add center-channel speakers and enjoy the full directional impact and clarity of Pro•Logic sound. You can even select Hall mode to enjoy surround effect on non-Dolby material (your favorite CDs, for example.) Digital tuner features 30 memory presets, memory scan and search. A/V dubbing controls, bass, treble FM mono, muting and loudness controls. Sleep timer, 3-day memory backup. Remote requires 2 "AA" batteries. (TSP)

31-3019 399.95

Pro•Logic™ Dolby Laboratories Licensing Corp.
Available Sept. 30, 1992



Main amplifier: 100 watts per channel, minimum rms into 8 ohms from 20-20,000 Hz, with no more than 0.05% total harmonic distortion
Center channel: 20 watts total, minimum rms into 8 ohms at 1 kHz, with no more than 0.5% THD
Rear channels: 20 watts per channel, minimum rms into 8 ohms at 1 kHz, with no more than 0.5% THD

F.Y.I.

DIGITAL-SYNTHESIZED PLL TUNING. Locks selected frequency to a precise quartz-crystal reference to improve reception and eliminate drift.

MEMORY PRESETS. Store AM/FM frequencies for one-touch recall.

LOUDNESS. When switched on, increases low and high-frequency (bass and treble) output normally less audible at low volume levels.

FM MONO. Instantly switches receiver from stereo to monaural operation to improve reception of weak or distant FM stations.

FM MUTING. Eliminates interstation noise when tuning.

PRO•LOGIC SURROUND. Accurately replicates live sound by balancing and steering dialogue and effects to their proper position in the sound stage—directional sounds to the front, environmental sounds to the rear and/or side, and dialogue to the front center.



Optimus 10-Band Equalizer With IMX™ Stereo Expander. Hear sound from between, even *beyond* your speakers! Has 20 narrow-band controls for precise adjustments and a 90-LED spectrum display for analyzing the sound shape. Bypass button for sound comparisons. Tape control center, EQ/record button. (TSP) **31-2025 119.95**



Optimus STA-20. Our smallest, lowest priced stereo receiver delivers excellent sound and is ideal for dorm, office or reception area. Features magnetic phono and aux jacks, plus CD/tape input for connecting a CD or cassette portable. EQ circuit provides uniform energy output. Loudness control. Just 2 3/4 x 10 1/4 x 7 1/4". (TSP) **31-1979 99.95**



(1) Optimus LAB-2250 Turntable. Linear-tracking straight-line tonearm delivers excellent sound and extends record life. Features auto start/shutoff and repeat play. Belt-drive mechanism absorbs vibration. 33 1/3 or 45-RPM selector. LED repeat-play and record-speed indicators. With dual-magnet cartridge. Rumble: -55 dB. Wow and Flutter: 0.1%. UL listed AC. (TSP) **42-2921 149.95**

(2) Realistic® LAB-340 Turntable. Features stereo preamp to match ceramic phono, aux and tape inputs. Straight-line tonearm, auto arm return/shutoff. 33 1/3 or 45-RPM selector, anti-static mat. Includes dual-magnet cartridge. Rumble: -55 dB. Wow and Flutter: 0.15%. UL listed AC. (TSP) **42-2919 99.95**



(1) Realistic SA-10 Amplifier. Micro-size. Inputs for a record player with ceramic cartridge plus tuner or tape deck. Stereo/mono button, left/right volume controls, tone control. 3 1/4 x 8 x 5 1/2". UL listed AC. **31-1982 29.95**

(2) Realistic TM-150 Tuner. Mini tuner features PLL circuitry and exclusive Auto-Magic® FM tuning to ensure best possible reception. Built-in antennas, terminals for external FM antenna. 2 1/2 x 9 x 6". UL listed AC. (TSP) **31-1956 59.95**

(3) Realistic SA-150 Amplifier. Mini size matches tuner above. Magnetic/ceramic phono input for use with all turntables, plus stereo/mono button, tone control and 1/4" headphone jack. 2 1/2 x 9 x 6". UL listed AC. (TSP) **31-1955 59.95**

OPTIMUS... LIVE IN CONCERT!®

No other technology brings you the sound of live music more accurately than digital audio. Optimus compact disc players make the most of this technology, delivering the full audio spectrum with richness and clarity. And, they offer the latest features to enhance your listening enjoyment. Whatever your music, choose Optimus for great performances.

F.Y.I.

OVERSAMPLING. "Rechecks" the digital information on a disc to ensure accuracy.

INTRO SCAN. Provides 10-second "preview" of tracks.

RANDOM PLAY. Randomly selects (shuffles) track order for variety.

AUTO EDIT. Programs maximum number of tracks to fit a cassette for recording.

AUTO SPACE. Inserts a 3-second blank space between tracks on a tape.

AUTO-SEARCH. Locates previous/next track at the touch of a button.

AUDIBLE SEARCH. High-speed forward/reverse search helps find a desired section of the music.



NEW! Optimus CD-6220 5-Disc Front-Loading Carousel Changer. Enjoy hours of uninterrupted digital stereo! Play up to five CDs in sequence, program up to 32 selections in any order or choose random play for variety. Replay one or all discs, your programmed tracks, a single track or a segment of a disc with 5-way repeat. Features intro scan, auto space, auto-search and audible search, plus a 1/4" headphone jack with volume control. Eight-times oversampling ensures brilliant live-concert sound. 3" CD compatible. Remote requires 2 "AA" batteries. (TSP) 42-5024, 229.95



NEW! Optimus CD-6130 5-Disc Top-Loading Carousel Changer. Top-loading design lets you easily view disc titles and add or remove discs without interrupting play. You can play up to five CDs in sequence, program up to 32 selections in any order, repeat one/all discs or your programmed tracks, even vary the concert with random play. Features intro scan, auto-search and audible search, plus 8-times oversampling for pure, dynamic sound. 3" CD compatible. Remote requires 2 "AA" batteries. (TSP) 42-5025 219.95

(1)

(2)

(3)



(1) Optimus CD-1660. Superb sound, real convenience. Program your selections and see up to 16 track numbers on the music calendar. Repeat your program, a track or the disc, even replay a segment with A-B repeat. Has random play, intro scan, auto-space, auto-search and audible search, plus a 1/4" headphone jack with volume control. Eight-times oversampling. 3" CD compatible. Remote requires 2 "AA" batteries. (TSP) 42-5031 179.95

(2) Optimus CD-1760. Enjoy top performance and an array of outstanding features. You get 32-track programmable memory and a 20-track music calendar display, 3-way track/disc/memory repeat, random play to shuffle selections, auto edit for easy dubbing, auto-space, auto-search and audible search. Eight-times oversampling. Has 1/4" headphone jack with volume control. 3" CD compatible. Remote requires 2 "AAA" batteries. (TSP) 42-5030 179.95

(3) NEW! Optimus CD-2470. Even our lowest priced player offers 8-times oversampling for sound that's faithful to the live performance. It's full-featured, too, with 16-track programmable memory, 3-way program/track/disc repeat, random play to shuffle selections, and auto-space for dubbing personal CDs to cassettes. Auto-search and audible search help find desired tracks fast. With 1/4" headphone jack. 3" CD compatible. Remote requires 2 "AAA" batteries. (TSP) 42-5032 159.95

Enjoy superb digital stereo on the go with a high-performance Optimus® CD portable

Why settle for less than the best? With Optimus portable CD players you can enjoy the magnificent sound of compact discs on the patio, at the park, in your car, truck or van.

Simply add stereo headphones for portable use. These players plug into the CD jack on auto sound equipment or you can use the CD-to-cassette adapter, below.



Easy to mount and enjoy in your car, truck, van or RV



Live in Concert! Programmable CD Portables with Eight-Times Oversampling

NEW! Optimus CD-3260. Enjoy spectacular digital stereo sound plus extended low frequencies thanks to Bass-Boost. Features 20-track programmable memory, 2-way repeat of one or all tracks, intro scan to preview tracks, and auto search to find individual tracks easily. LCD digital display, built-in Ni-Cd charging circuit for rechargeable batteries, 1/8" headphone jack and line-out jacks for playback through your home stereo, carry strap. 3" CD compatible. Requires 6 "AA" batteries or AC adapter/charger. (TSP) **42-5018** **159.95**

NEW! Optimus CD-3370. Extra convenient—the wired remote control makes it ideal for use in your car, truck or van. Has Bass-Boost/Hi-Boost control for customizing sound to your liking, 22-track programmable memory, intro scan, random play for variety, 5-way repeat and auto-search. LCD display, 1/8" headphone and line-out jacks for connecting to home stereo, carry strap. 3" CD compatible. Requires 2 "AA" batteries or AC adapter/charger. (TSP) **42-5029** **179.95**

Get the most out of your CD portable with these accessories



(1) Realistic Minimus® 0.8 Amplified Speaker System. Just plug into your CD portable's 1/8" stereo headphone jack for superb sound at home or on-the-go. Bass boost and volume controls. 2 x 4" drivers. Output: 3 watts per channel. 6 3/4" x 2 7/8" x 5 1/8". Requires 8 "C" batteries. **40-1313, PAIR 49.95**

(2) Minimus-0.6 Amplified Speaker System. Enjoy your portable CD player on the patio, at poolside or at the park. Big-sounding little speakers feature 2 1/2" drivers, carry case and audio cable. Output: 2 watts per channel. 5 5/8" x 3 1/4" x 3 1/4". Requires 8 "C" batteries. **40-1259** **PAIR 39.95**

(3) Minimus-0.4 Amplified Speaker System. Speakers interlock for easy portability and separate for improved stereo. Big 4" drivers, separate bass and treble controls, carry strap. 5 x 4 3/4" x 2 1/2". Requires 4 "C" batteries or AC or DC adapter. **40-1267** **PAIR 29.95**

(4) NEW! Amplified Mini System. Our lowest priced amplified speakers are compact-sized to fit perfectly on a desktop. Bass and treble boost controls let you customize sound to your liking. Output: .75 watt per channel. 3 7/8" x 3 3/8" x 2 1/8". Requires 4 "AA" batteries. **40-167** **PAIR 19.95**



(1) Vehicle-Mount CD Bracket. Holds your CD portable securely at any angle. Skip-reducing damping action. Pre-assembled platform, universal swivel mount. With hardware and under-dash mounting bracket. **42-3050** **24.95**

(2) CD Player-to-Cassette Adapter. Play your CD portable through car cassette or home cassette deck. Plugs into portable's 1/8" headphone jack, loads like a tape. **12-1951, 19.95**

(3) PRO-25 Headphones. Titanium-layered diaphragms, oxygen-free coil windings and neodymium magnets combine for pure, dynamic stereo. Response, 15-25,000 Hz. 6-ft. cord with in-line volume control and 1/8" plug. **33-1022, 39.95**

PORTABLE CD PLAYERS REQUIRE STEREO HEADPHONES WITH 1/8" PLUG—SEE PAGE 51 FOR OUR COMPLETE SELECTION

One more time! Play it again on a stereo cassette deck



(1) Full-Featured Dual-Cassettes With Convenient High-Speed Dubbing

- (1) **Optimus® SCT-37.** Enjoy performances that continue where others end. Dual auto-reverse plays both sides of two tapes automatically and simplifies dubbing by copying both sides of a tape at high or normal speed with one touch of the synchro-start control. Dolby™ HX Pro makes this deck ideal for recording from digital audio—captures the wide dynamic range of CDs and transfers more signal to tape without audible distortion. You also get Dolby B-C to enhance sound quality on playback. Automatic metal/CrO₂/normal tape selector sets bias and equalization for best sound from any type of tape. Features quick-reverse for nearly inaudible change of tape side, plus continuous mode to auto-play two tape sides in sequence. With LED record-level and peak-level meters, plus 1/4" jacks for adding mikes and headphones. Was \$279.95 in 1992 Catalog. (TSP) 14-659 . . . **New Low Price! 259.95**
- (2) **Optimus SCT-36.** Just the thing for extended listening and really easy tape duplication. Features dual auto-reverse and high-speed synchro-dubbing, Dolby B-C for enhanced sound on playback, continuous play, automatic tape selector, and LED record-level and peak-level meters. With 1/4" jacks for adding mikes and headphones. Was \$229.95 in 1992 Catalog. (TSP) 14-658 . . . **New Low Price! 199.95**
- (3) **NEW! Optimus SCT-39.** Even at this low price you'll enjoy the convenience of high-speed synchro-dubbing plus remarkably true-to-life sound on your recordings thanks to Dolby B-C and HX Pro. Continuous play, metal/CrO₂/normal tape bias selectors, LED record-level meter. With 1/4" jacks for adding mikes and headphones. (TSP) 14-662 (Available Sept. 30, 1992) . . . **169.95**
- (4) **Optimus SCT-38.** Features high and normal-speed dubbing with one-touch synchro-start, Dolby B for improved sound, continuous play, metal/CrO₂/normal tape bias selectors and LED record-level meter. With 1/4" jacks for adding mikes and headphones. (TSP) 14-660 . . . **139.95**



Compact Record/Playback and Play-Only Decks

- (1) **Realistic® SCP-32 Player.** Auto-reverse—just the thing for background music, music-on-hold or uninterrupted entertainment. Even at this low price, you get Dolby B, metal-CrO₂/normal tape selector, auto-stop and pause control. (TSP) 14-600 . . . **99.95**
- (2) **Realistic SCT-86 Recorder/Player.** The low-cost way to add a full-featured recording deck to any stereo system. Features Dolby B, auto-stop to protect tapes and player's mechanism, dual record-level controls and LED record-level meters. Metal-CrO₂/normal tape selector, pause control, tape counter, 1/4" jacks for adding mikes. (TSP) 14-654 . . . **89.95**
- (3) **Realistic SCP-31 Player.** Just right for office, dorm or bedroom—the inexpensive way to add cassette playback to any existing stereo system with aux or tape-in jacks. Auto-stop, metal-CrO₂/normal tape selector, pause control. 14-647 . . . **49.95**

Model and Cat. No.	SCT-37 14-659	SCT-36 14-658	SCT-39 14-662	SCT-38 14-660	SCP-32 14-600	SCT-86 14-654	SCP-31 14-647
Type	Recording	Recording	Recording	Recording	Play-Only	Recording	Play-Only
High-Speed Dubbing	✓	✓	✓	✓			
Auto-Reverse	Dual	Dual			✓		
Continuous Play	✓	✓	✓	✓			
Dolby System: B	✓	✓	✓	✓	✓	✓	
C	✓	✓	✓	✓			
HX Pro	✓		✓				
Tape Selector	Auto	Auto	Manual	Manual	Manual	Manual	Manual
Headphone Jack	✓	✓	✓	✓			
Mike Jacks	✓	✓	✓	✓		✓	



Audio Source Control Center. A terrific addition to your audio system. Expands an amplifier or receiver's single auxiliary input to play from three stereo sources. 42-2110 . . . **14.95**

3-Input/Output Control Center. Adds versatility to your home recording studio by letting you monitor, record and dub with up to three separate cassette decks. Ends the hassle of patch cord swapping, too. Connects to tape monitor jacks. 42-2115 . . . **25.95**

OPTIMUS...LIVE IN CONCERT!®

High-performance speaker systems

Discover what millions of satisfied listeners know—for unparalleled value and quality, there's no better place to buy speakers than Radio Shack. Together, our Optimus® and Realistic® speakers outsell every other brand in the USA. Each is designed to deliver full-range, life-like sound. Most are finished in genuine walnut—not vinyl or plastic like so many brands. And all must pass strict quality control.

5-Year Limited Warranty Included

Realistic Nova, Minimus 7/77/26/21/0.3/2.5, Optimus and Mach Three speaker systems are warranted against defects for five years from the date of purchase. Within this period Radio Shack will repair the equipment without charge for parts or labor. Simply bring in your sales slip as proof of purchase date to your Radio Shack store. Warranty does not cover equipment subjected to misuse or accidental damage. This warranty gives you specific legal rights and you may also have other rights which vary from state to state.

POWER RATINGS. The figures stated with 40-series speaker systems indicate the speaker may be used with equipment delivering up to the stated (RMS) continuous power per channel driven to clipping 10% of the time on normal source material.



Optimus Mach Three®. Experience true concert-like sound—a magnificent blend of rich bass, smooth midrange and crisp, clean treble. The massive 15" woofer and bass-reflex, tuned-port design team up for *bass you can actually feel*. The midrange and tweeter horns are ferrofluid-cooled to increase power handling without adding distortion, and have variable level controls to adjust output to your taste or listening-room acoustics. Removable cloth grille. Furniture-grade oiled walnut finish.

40-4039 Each **299.95**
 Response: 30-20,000 Hz. Power Handling Capacity: 160 watts. Size: 30 x 17 1/4 x 13".

Optimus-1050. An excellent value incorporating qualities usually found only in more expensive speakers. Its high-performance design is the perfect complement to today's high-powered digital audio systems. A tuned port combines with the huge 15" woofer for superb low-frequency response. The 5" midrange is engineered for smooth, natural sound, and the 3" cone tweeter delivers pure, accurate highs. Handsomely styled, with removable cloth grille and furniture-grade oiled walnut finish.

40-1131 Each **199.95**
 Response: 55-20,000 Hz. Power Handling Capacity: 100 watts. Size: 29 1/4 x 17 1/4 x 12".

(1) Optimus-990. Our finest 2-way speaker is a powerful performer! The giant 15" long-throw woofer and tuned port join together to pump out rock-solid bass, while the wide-dispersion, 3 x 15" horn tweeter brings out detailed highs. Removable cloth grille, real walnut finish.

40-1125 Each **169.95**
 Response: 50-20,000 Hz. Power Handling Capacity: 100 watts. Size: 23 1/4 x 19 1/2 x 11 1/4".

(2) Optimus-950. Enjoy great sound plus handsome styling that's at home in any room. Features bass-reflex design with long-throw 12" woofer for deep, rich bass, a 5" dynamic midrange and a 3" cone tweeter for crisp highs. Removable cloth grille, real walnut finish. Was 169.95 in 1992 Catalog.

40-1122 **New Low Price! Each 139.95**
 Response: 50-20,000 Hz. Power Handling Capacity: 100 watts. Size: 30 1/4 x 14 1/4 x 11 1/4".

(3) Optimus-660. A 3-way system at a remarkable low price. Efficient long-throw 10" woofer and tuned port work in concert for accurate bass response, while the 5" dynamic driver and 2 x 3" wide-dispersion horn tweeter ensure smooth midrange and clean highs. Removable cloth grille, real walnut finish.

40-1102 Each **129.95**
 Response: 55-20,000 Hz. Power Handling Capacity: 100 watts. Size: 25 1/2 x 12 1/4 x 10 1/4".



(1) **Realistic Nova®-18.** An excellent low-priced 2-way system for high-powered digital audio. The tuned-port bass-reflex design and 10" long-throw woofer combine for rock-solid low-frequency response, and the 3" tweeter is ferrofluid-cooled for crisp highs with low distortion. Genuine walnut veneer. Removable cloth grille. Response: 65-20,000 Hz. Power handling capacity: 100 watts. $22\frac{5}{8} \times 12\frac{3}{16} \times 8\frac{1}{8}$ ". 40-4037 Each 99.95

(2) **NEW! Realistic Nova-14.** Value-priced two-way acoustic-suspension system with 6 $\frac{1}{2}$ " woofer, 1" tweeter. Genuine walnut veneer. Removable cloth grille. Response: 70-20,000 Hz. Power handling capacity: 50 watts. $14\frac{7}{8} \times 8\frac{7}{8} \times 8\frac{3}{4}$ ". 40-4038 Each 89.95

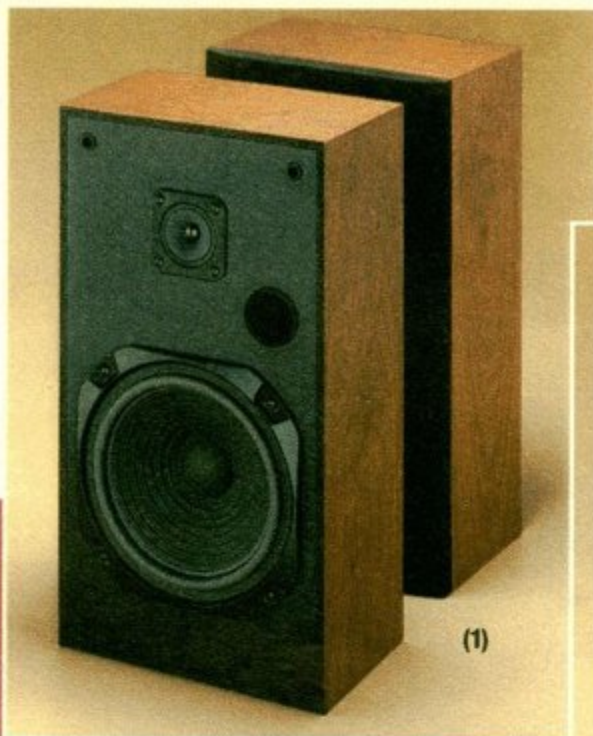

(1)



(2)

For value, quality and selection, think Realistic

You'll be in good company. Millions of listeners have trusted the Realistic® brand for true-to-life sound since 1956. Each Realistic speaker, from our powerful subwoofer to extension speakers, meets tough quality-assurance standards. Whether for your home audio system, vehicle installation or a personal stereo, there's a Realistic speaker just right—and at the right price—for you.

(3) **Realistic Nova-16.** Smart choice for placement on floor or a larger shelf. Bass-reflex design with 8" long-throw woofer and 2 $\frac{1}{2}$ " wide-dispersion tweeter. Real walnut veneer. Removable cloth grille. Response: 65-20,000 Hz. Power handling capacity: 60 watts. $18\frac{1}{2} \times 10\frac{1}{4} \times 7\frac{1}{2}$ ". 40-4036 Each 79.95

(4) **Realistic Minimus-26.** Compact sized, with big-speaker performance. Sealed-enclosure system with 5" long-throw woofer and 2 $\frac{1}{2}$ " tweeter. Walnut vinyl finish. Removable cloth grille. Response: 90-20,000 Hz. Power handling capacity: 40 watts. $11 \times 6\frac{3}{4} \times 4\frac{3}{8}$ ". 40-226 Each 36.95



(3)



(4)

Share the Music! Amplified Speakers Make Any Stereo Portable a Mini-System



(1)

(2)

(3)

(4)

(5)

Enjoy amplified sound from any personal stereo or portable CD player. Just plug these battery-powered speakers into a $\frac{1}{8}$ " stereo headphone jack for superb sound at home or on-the-go.

(1) **NEW! Minimus-0.7.** Bass-reflex system with 3 $\frac{1}{2}$ " woofers, 1 $\frac{1}{2}$ " tweeters. Surround-sound, bass boost, volume controls. Output: 3.5 watts/channel. $7 \times 5\frac{1}{4} \times 5$ ". Requires 8 "C" batteries. 40-1312, PAIR 59.95

(2) **NEW! Minimus-0.8.** Enjoy on the patio or at the park. Bass boost and volume controls. 2×4 " drivers. Output: 3 watts per channel. $6\frac{3}{4} \times 2\frac{7}{8} \times 5\frac{1}{8}$ ". Requires 8 "C" batteries. 40-1313 PAIR 49.95

(3) **Minimus-0.6.** Big-sounding little speakers feature 2 $\frac{1}{2}$ " drivers, carry case and audio cable. Output: 2 watts per channel. $5\frac{5}{8} \times 3\frac{1}{4} \times 3\frac{1}{4}$ ". Requires 8 "C" batteries. 40-1259 New Low Price! PAIR 39.95

(4) **Minimus-0.4.** Interlocking. 4" drivers, separate bass and treble controls, strap. Output: 1.5 watts per channel. $5 \times 4\frac{3}{4} \times 2\frac{1}{2}$ ". Requires 4 "C" batteries or AC or DC adapter. 40-1267 PAIR 29.95

(5) **NEW! Personal Mini System.** Our lowest priced, yet rich-sounding. Ideal on a desktop. Bass and treble boost. Output: .75 watt per channel. $3\frac{7}{8} \times 3\frac{3}{8} \times 2\frac{1}{8}$ ". Requires 4 "AA" batteries. 40-167 PAIR 19.95

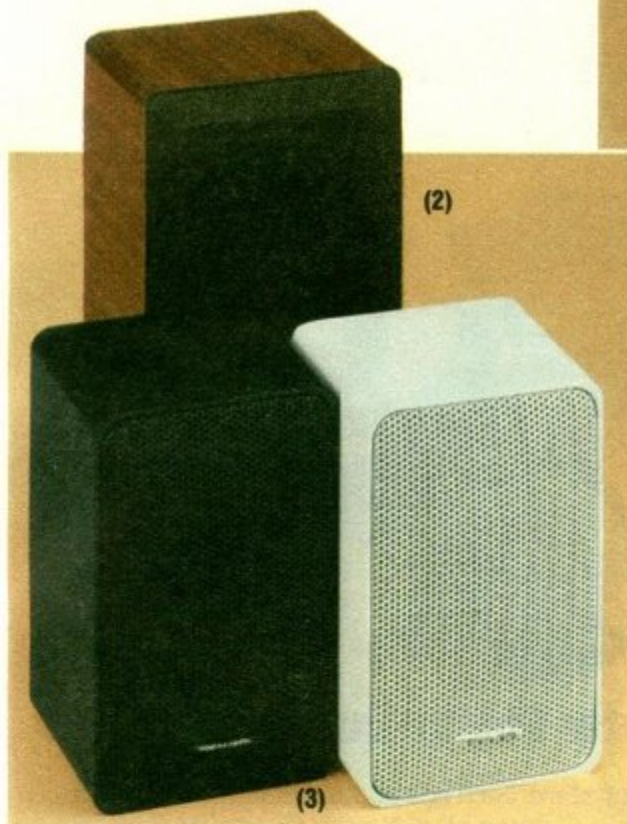

(2)

(3)

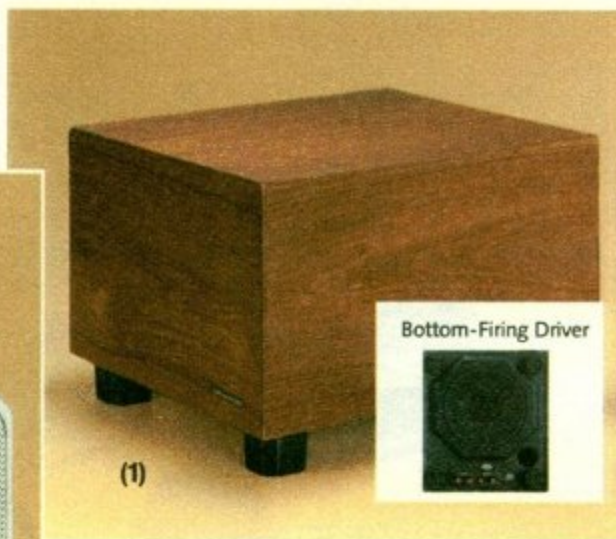

Bottom-Firing Driver

(1)

(1) Realistic 12" Subwoofer. Enjoy thunderous bass, even in a room too small for large speakers. This is the perfect complement to our Minimus-7 and 77 systems plus other smaller speakers that lack the "punch" only a subwoofer can provide. And because low-frequency output is non-directional, you can place it almost anywhere in a room. Features a long-throw 12" driver with dual voice coils for bass you can actually feel, a built-in crossover and push terminals for input from receiver and for connecting satellite speakers. Response: 35-200 Hz. Power handling capacity: 100 watts total. Genuine oiled-walnut veneer, not plastic or vinyl. 12⁵/₈ × 18¹/₈ × 15³/₄". **40-4050 149.95**

(2) Realistic Minimus-7W. Our renowned 2-way system in a handsome oiled-walnut finish. Only 8" high—just right on a bookshelf, ideal for surround sound and the perfect satellite speaker for the subwoofer above. Long-throw 4" woofer, soft-dome 1" tweeter. 120-20,000 Hz. 40 watts. 8 × 5 × 4⁵/₈". **40-2039 Each 59.95**

(3) Realistic Minimus-7. Our famous die-cast system with the same features and superb sound of Fig. 2. Just 7¹/₁₆" high, fits nearly anywhere. Recessed spring terminals, keyhole hanger slot. 7¹/₁₆ × 4⁷/₁₆ × 4³/₁₆". **Black, 40-2030. White, 40-2045 Each 49.95**

Mounting Brackets. Black, 40-2031. White, 40-2060 (CMC) PAIR 17.95

(4) Realistic Minimus-77. Die-cast system combines a 5" woofer and 1" tweeter. Excellent in a vehicle or as a monitor speaker for singers. Keyhole slot, spring terminals. Response: 50-20,000 Hz. Capacity: 55 watts. 9¹/₄ × 5¹⁵/₁₆ × 4³/₈". **Black, 40-2054. White, 40-2055 Each 79.95**

Mounting Brackets. Black, 40-2053 (CMC). White, 40-2062 (CMC) PAIR 19.95

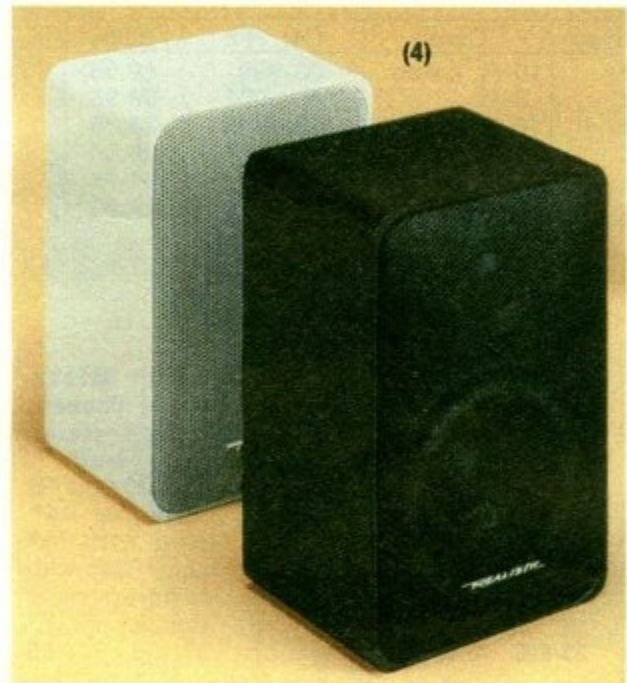

(4)

Big-sounding, Best selling Minimus speakers

Big surprises do indeed come in small packages, as our remarkably rich-sounding Minimus® speakers prove. Take the popular Minimus-7, for example—America's best-selling speaker. It provides clean, accurate sound—tight bass, smooth midrange and crisp highs—across the audio spectrum. And, it delivers years of listening enjoyment. Versatile Minimus speakers put big sound in small places. P.S. No wonder we've sold millions of them!

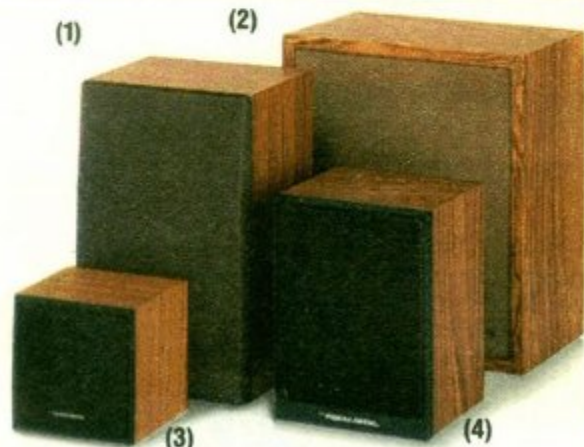

(1)

(2)

(3)

(4)

(1) Minimus-21 Walnut-Vinyl Speaker. 4" driver. 10 watts. 9³/₈ × 5⁵/₈ × 4³/₄". **40-228 Each 26.95**

(2) Minimus-3. Full-range 5" driver. 7 watts. 10 × 8¹/₂ × 5¹/₂". **40-913 Each 16.95**

(3) Minimus-0.3. Cube speaker with 3" driver. 7 watts. 4 × 4 × 3³/₈". **40-1250 Each 15.95**

(4) Minimus-2.5. Shielded, OK near TV. 4" driver. 10 watts. 6⁵/₈ × 4⁷/₈ × 4¹/₈". **40-1999 Each 19.95**

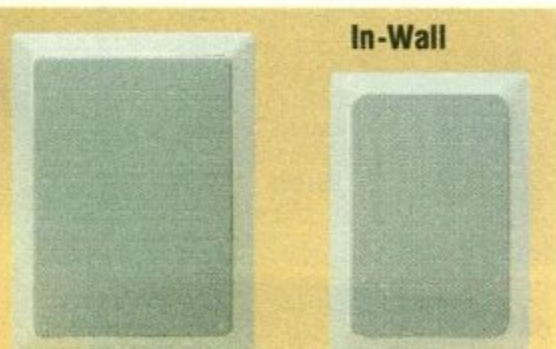

In-Wall

NEW! 8" 2-Way System. Flush-mounts in wall or ceiling. Has 8" woofer and 1" soft-dome tweeter. Response: 40-20,000 Hz. Capacity: 50 watts. Mounting bracket. 14¹¹/₁₆ × 10¹¹/₁₆ × 3³/₈". **40-1366 Each 99.95**

5¹/₄" 2-Way System. As above, with 5¹/₄" woofer, 1" tweeter. Response: 60-20,000 Hz. Capacity: 30 watts. Mounting bracket. 11¹/₈ × 7⁵/₈ × 2¹/₂". **40-1365 Each 49.95**

Angled Stands for Speakers. Enhance sound and improve stereo imaging by elevating and angling speaker systems. 7¹/₂ × 13¹/₁₆ × 10¹/₈". **40-1266, PAIR 34.95**

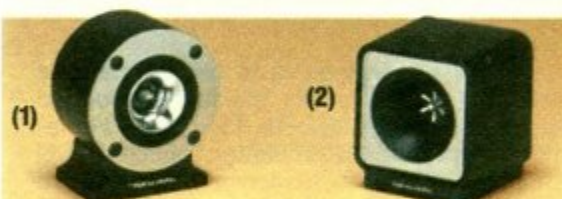
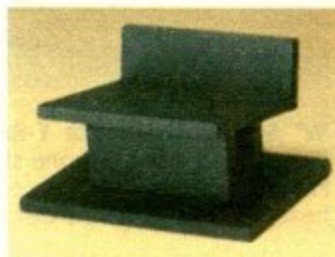

(1)

(2)

(1) Dynamic Super Tweeter. Extends response to 40,000 Hz. Built-in crossover. Capacity: 50 watts. 3⁷/₈" diameter. **40-1310, Each 24.95**

(2) Piezo Super Tweeter. Extends response to 27,000 Hz. Capacity: 75 watts. 3¹/₂" square. **40-1380 Each 12.95**

Realistic Minimus-3.5. Great for desktop or vehicle. High-density molded enclosure with steel grille. 3" driver. Capacity: 15 watts. 5¹/₄ × 3⁵/₈ × 3¹/₈". **40-1996 Each 24.95**



Personal Speaker. Share the music! Plugs into 1/8" headphone jack of most personal stereo cassette and CD players. **40-155 9.95**



Discover personal stereo listening at its very finest

Radio Shack is the store that offers you a choice in headphones. Instead of few, we offer 17 quality models to bring rich stereo music to your ears.



NEW! PRO-80. Engineered to convey the wide dynamics of digital audio. Titanium-evaporated diaphragms deliver smooth 15-25,000 Hz response. Convenient attenuating volume control is built into the 8-ft. oxygen-free-copper cord with gold-plated 1/4" plug. (TSP) 33-1011, 69.95



Full-Size Headphones for Studio-Quality Sound

The perfect addition to your home audio system. Each has padded earcushions so you can listen in comfort for hours. All have a 1/4" stereo plug. Nova®-66 and LV-20 have inline volume/balance controls. Nova-28 has balance controls on the earcups.

Fig.	Model	Frequency Response	Cord	Cat. No.	Each
1	PRO-60	15-25,000 Hz	10-Ft. coiled	33-999	49.95
2 NEW!	LV-20	20-20,000 Hz	8-Ft.	33-1001	39.95
3	Nova-66	20-20,000 Hz	10 Ft.	33-1025	34.95
4	Nova-55	20-20,000 Hz	10-Ft. coiled	33-2004	29.95
5	Nova-40	30-18,000 Hz	10-Ft. coiled	33-993	24.95
6 NEW!	Nova-28	20-20,000 Hz	9-Ft.	33-1029	19.95



Our Best In-Ear Stereo Phones. Deep bass! 16-22,000 Hz response. 40" cord, handy inline volume control, gold-plated 1/8" plug. With case. 33-991 29.95



Stereo "Ear-buds". Easy to carry. Phones and cord wind up inside the case. 0.42 oz. 120-20,000 Hz response. 43" cord with 1/8" plug. 33-980 13.95



NEW! Micro In-Ear Phones. 0.5 oz. stereo "ear buds". 120-20,000 Hz response. 46" cord with 1/8" plug. Case with wind-up cord storage. 33-970 ... 8.95



NEW! Add-On Volume Control for Headphones. Just plug in to add a convenient inline attenuating volume control to any stereo headphones equipped with 1/8" plug. 1-ft. cord. 42-2459 4.95



20-Foot 1/8"-to-1/4" Extension Cord. Has 1/8" stereo plug at one end and a 1/4" stereo jack at the other end. Connect full-size phones to 1/8" stereo headphone jack. 42-2464 5.99



20-Foot 1/4"-to-1/8" Extension Cord. Has 1/4" stereo plug at one end and an 1/8" stereo jack at the other end. Connect your lightweight headphones to a 1/4" stereo headphone jack. 42-2460 5.99



20-Foot 1/8" Headphone Extension Cord. Lightweight, flexible, extra-durable stereo audio cable with 1/8" stereo plug at one end and 1/8" stereo headphone jack at the other end. 42-2462 6.39

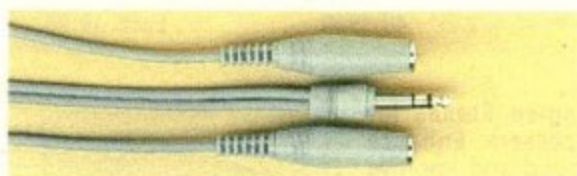

1/4" Stereo Headphone Y-Adapter. Connect two stereo headphones to one stereo headphone jack. Has 1/4" stereo plug at one end and two 1/4" stereo headphone jacks at the other end. 42-2448, 5.39



1/8" Stereo Headphone Y-Adapter. Connect two stereo headphones to one stereo headphone jack. Has 1/8" stereo plug at one end and two 1/8" stereo headphone jacks at the other end. 42-2463, 4.99



Lightweight Headphones for Superb Stereo To-Go

Upgrade your personal stereo player! All have a 1/8" stereo plug. PRO-25 features titanium-layered diaphragms for wide, super-linear response. It's equipped with an inline volume control and gold-plated plug. Nova-45 includes a 1/8" to 1/4" plug adapter.

Fig.	Model	Fold-Up	Frequency Response	Cord	Cat. No.	Each
1	PRO-25		15-25,000 Hz	6-Ft.	33-1022	39.95
2	Nova-45		20-20,000 Hz	6 1/2-Ft.	33-1021	24.95
3	Nova-53	✓	50-20,000 Hz	5-Ft.	33-981	19.95
4	Nova-37	✓	50-20,000 Hz	45"	33-2003	15.95
5 NEW!	Nova-38		50-20,000 Hz	6-Ft.	33-982	11.95
6	Nova-36	✓	40-20,000 Hz	4-Ft.	33-2002	8.95
7	Nova-34		Wide Range	4-Ft.	33-1000	5.95

Extra Foam Earpads for Nova-34. (Not shown.) 33-375 Pair 99c



New! Wireless Headphone System

Enjoy crystal-clear monaural sound anywhere in the room, without wires. Transmitter plugs into radio or TV headphone jack and sends an infrared signal up to 20 feet to the headphones. (For use with stereo equipment, add our #274-374 or #274-363 adapter, page 106. Sound will be mono.) With UL listed AC adapter and 1/8" -to-1/4" adapter. Headphones require 2 "AAA" batteries. 32-2052 ... 59.95

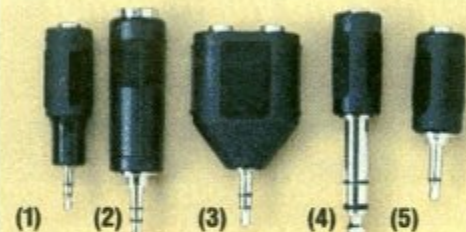

Headphone Plug Adapters

(1) Accepts 1/8" Stereo Plug. Plugs Into 3/32" Stereo Jack. Connect lightweight headphones to a portable that has a 3/32" headphone jack. 274-373 ... 2.99

(2) Accepts 1/4" Stereo Plug. Plugs Into 1/4" Stereo Jack. Connect full-size stereo headphones to portables that have an 1/8" stereo headphone jack. 274-366 ... 1.79

(3) Accepts Two 1/8" Stereo Plugs. Plugs Into 1/4" Stereo Jack. Share your music! Lets you connect two headphones to one player. 274-313 3.29

(4) Accepts 1/8" Stereo Plug. Plugs Into 1/4" Stereo Jack. Connect lightweight stereo headphones to a stereo system that has a 1/4" headphone jack. 274-367 ... 1.79

(5) Accepts 1/8" Stereo Plug. Plugs Into 1/8" Monaural Jack. Connects lightweight stereo headphones to monaural TVs, radios, walkie-talkies and scanners. 274-368 1.19



Pillow Speaker. Slips under pillow and lets you listen to TV or radio without disturbing others. 4-ft. cord with 1/8" monaural plug. (For use with stereo equipment, add our #274-374 or #274-363 plug adapter, page 106. Sound will be mono.) 33-206 ... 3.59



NEW! Deluxe Pillow Speaker. Fits under pillow. Ideal for enjoying TV, radio, and books on cassette. Has volume control and 6-ft. cord with 1/8" monaural plug. (Add plug adapter for use with stereo equipment. Sound will be mono.) 33-208 ... 4.99

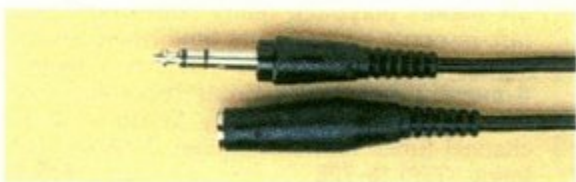

24-Foot 1/4" Coiled Headphone Extension Cord. Coiled, nontangling stereo audio cord with 1/4" stereo plug at one end and 1/4" stereo jack at the other end. 42-2443 8.39



Monaural Earphone. With ear clip and 3 1/4" cord. With 3/32" Submini Plug. 33-174 1.79
With 1/8" Mini Plug. 33-175 1.79



Deluxe Monaural Earphone. With 1/8" mini plug. With 10-Foot Cord. 33-177 3.99
With 25-Foot Cord. 33-178 5.99



20-Foot 1/4" Headphone Extension Cord. Noncoiled stereo cord with 1/4" stereo plug at one end and 1/4" stereo jack at the other end. Just the thing to extend the cord of full-size headphones. 42-2442 .. 5.79

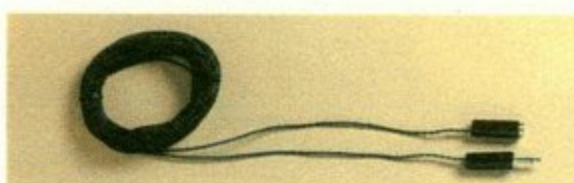

20-Foot 1/8" Earphone Extension Cord. Has 1/8" monaural plug at one end and 1/8" monaural jack at the other end. Enjoy TV or radio sound from across the room without disturbing others. 33-176 2.69



Foam Earpad Replacement Set. These soft, durable covers fit most lightweight stereo headphones. Includes four replacement pads, two blue and two black. 33-374 Set 2.79

HI-FI STEREO



NEW! Memorex™ VHS Model 52. Enjoy superior video and effects from 4-head, double-azimuth mid-mount design, plus auto video-noise reduction, VHS Hi-Fi Stereo and broadcast stereo-TV sound with SAP. Full auto system, auto-tracking, index and skip search, 1-year/8-event timer with on-screen English/Spanish prompts, quick-timer. Up-front A/V inputs, 179-channel tuner. Remote requires 2 "AA" batteries. (TSP) **16-622 .. 399.95**

HI-FI STEREO



NEW! Memorex VHS Model 51. Features 4-head, double-azimuth design with VHS Hi-Fi Stereo plus broadcast stereo-TV sound with second audio program (SAP). Auto power-on, play and rewind, index search, 1-year/6-event timer with helpful on-screen prompts in English and Spanish, quick-timer. A/V inputs, 179-channel tuner. Remote requires 2 "AAA" batteries. (TSP) **16-621 379.95**



NEW! Memorex VHS Model 92. VCR Plus™ system built into the remote eliminates timer programming—just enter the TV listing code number to record your selected program. Features 4-head, double-azimuth design, auto-tracking, 1-year/6-event timer with helpful on-screen prompts in English and Spanish, and quick-timer. A/V inputs, 179-channel tuner. Remote requires 2 "AAA" batteries. (TSP) **16-530 329.95**

Now showing... very affordable 8mm stereo deck, plus VHS

Discover the advantages of the 8mm video format

Enjoy superb video performance and real convenience. Videomakers especially will appreciate our two new 8mm models—just pop a tape from your 8mm camcorder into these machines for instant playback. No need for RF converters or VHS adapters. You can also record TV directly and enjoy prerecorded movies now available in 8mm. Easy to store, the compact tapes are about the size of audio cassettes.



HI-FI STEREO

NEW! Memorex 8mm Model 800 VCR. Advanced video features plus broadcast stereo-TV sound and SAP. A flying erase head provides seamless transitions between recorded segments, and "just-in-time" recording adjusts tape speed to fit

an automatic-timer recording onto cassette. Full auto system, auto-tracking, time search, 1-year/8-event timer, quick-timer. A/V inputs, 179-channel tuner. Remote requires 2 "AA" batteries. (TSP) **16-654 499.95**



HI-FI STEREO

NEW! Memorex Super VHS Model 35. Experience the added clarity of Super VHS—400 lines of horizontal resolution, plus VHS Hi-Fi Stereo with SAP. The 4-head, double-azimuth design, comb filter and Artificial Intelligence picture control combine to deliver outstanding video and effects. Automatic power-on/play/rewind/power-off makes playback really convenient, and fast-response system saves time when advancing or rewinding tape. Time search, 1-month/4-event timer, quick-timer recording and 4-hour extended Memory Sentinel. 179-channel tuner. Remote requires 2 "AAA" batteries. (TSP) **16-705 549.95**



HI-FI STEREO

NEW! Memorex VHS Model 53. Recording made simple! The wireless remote has VCR Plus built in so you can set the recording timer instantly by entering a program number found in your TV listings. Four-head, double-azimuth mid-mount design with auto head cleaning ensures optimum picture every play plus virtually maintenance-free operation. And, sensational video really comes alive thanks to VHS Hi-Fi Stereo sound. You also get automatic power-on/play/rewind/power-off, blank search, index search and 1-year/6-event timer. Front A/V inputs, 179-channel tuner. Remote requires 2 "AAA" batteries. (TSP) **16-623 449.95**

ALL MEMOREX VCRs HAVE CABLE-COMPATIBLE TUNERS, ELIMINATING THE NEED FOR CABLE BOXES IN MANY CASES.



NEW! Memorex VHS Model 93. Experience clear video—the 4-head, double-azimuth mid-mount design and video-noise reduction system ensure excellent clarity every play. Easy to use—features automatic power-on, play, rewind, stop and eject, plus fast response to tape commands, 1-year/8-event daily/weekly timer and quick-timer. 179-channel tuner. Remote requires 2 "AAA" batteries. (TSP) **16-531** **299.95**



NEW! Memorex VHS Model 91. Enjoy clear video and effects from the 4-head, double-azimuth design. Features helpful on-screen prompts in English, Spanish and French for easy remote programming. Auto power-on, play and rewind, fast response, auto-tracking, 1-year/6-event daily/weekly timer, quick-timer. 179-channel tuner. Remote requires 2 "AAA" batteries. (TSP) **16-529** **289.95**



Memorex VHS Model 29. Features fast response to tape commands—saves time when advancing or rewinding tape. Easy to use—just insert tape for fully automatic power-on, playback, rewind and power off. You also get a 1-year/8-event timer, plus quick-timer, which starts a timed recording at the touch of one button. 179-channel tuner. Remote requires 2 "AA" batteries. Without Memory Sentinel (TSP) **16-517** **239.95**

VCRs, TV/VCR combos and laser disc



New! Portable Color TV With Built-In 8mm VCR

Memorex 8mm Model 17 TV/VCR. Ideal for business presentations or for personal use—conveniently view 8mm cassettes and record programs at home, office or in your vehicle. Portable 5" color TV/monitor has top-loading 8mm VCR with hi-fi monaural sound, flying erase head for glitch-free editing, and auto-tracking control. On-screen displays, 179-channel TV tuner with auto channel memory. Records up to two hours on SP setting. With AC and vehicle DC power cords. Carry handle, built-in antenna, 75-ohm input, A/V inputs/outputs, 3" speaker. (TSP) **16-409** **799.95**

F.Y.I.

ON-SCREEN DISPLAYS. Prompts on your TV screen make programming easy.

DOUBLE-AZIMUTH. Video head alignment that optimizes clarity on both standard (SP) and slow (LP, EP) speeds.

AUTO CHANNEL MEMORY. Stores all active channels in one step, instantly.

SAP. Second audio program on stereo models, often 24-hour weather.

Memory Sentinel

Memorex exclusive! Protects clock/timer settings and channel memory with up to one hour of backup during loss of AC.



NEW! Memorex VHS Model 16 Video Cassette Player. For home or vehicle. Auto play, rewind and shutoff, plus fast response. RF cord for TV hookup, AC and DC power cords. Remote requires 2 "AA" batteries. (TSP) For playback only. **16-408** **199.95**

Color TVs with Built-In VHS Video Players



NEW! Memorex Model 20. Compact 19" TV/VCR is ideal for personal use in bedroom, dorm or office, and for video presentations to small groups in businesses, schools, churches and clubs. Features full auto system, so it's easy to use—just insert a tape for automatic play, stop, rewind and eject. Remote controls major TV and tape functions. You also get 3-speed recording and playback, forward/reverse visual search for finding scenes on tape quickly and auto-repeat. Convenient remote on-screen programming and quick-start recording. Dark-glass screen keeps colors brilliant even in bright light.

Cable-compatible 181-channel tuner with auto-storage. A/V inputs, 75-ohm "F" connector, 1/8" ear-phone jack. UL listed AC. Remote requires 2 "AA" batteries. (TSP) **16-412** **599.95**

NEW! Memorex Model 18. As above, with 13" screen, 155-channel tuner. Remote requires 2 "AA" batteries. (TSP) **16-410** **499.95**

NEW! Memorex Model 19. Color 9" TV with built-in video cassette player only. Plays on AC or vehicle 12VDC. 179-channel tuner. Remote requires 2 "AA" batteries. (TSP) **16-411** **499.95**



HI-FI STEREO

CD/Laser Video Disc Player

Realistic MD-1000. Delivers a movie-clear picture superior to all other video formats plus stunning digital stereo. Plays laser video discs, standard and 3" CDs, and 5" CDVs. Remote 20-track/chapter programming with on-screen displays. Memory-stop restarts a disc where you stopped it. 4x oversampling. RF and A/V outputs. Remote requires 2 "AAA" batteries. (TSP) **16-302** .. **399.95**

Capture all the sights, sounds and magic of the moment with a Memorex™ camcorder—there's one that's just right for you

NEW! Memorex 8mm Model 157. Palm-sized, packed with features and a delight to use! Just point and shoot—the one-touch full auto system makes focus, color balance, exposure and shutter speed worry-free. Advanced 16x digital zoom with macrofocus brings distant action dramatically close, and 1-lux low-light sensitivity provides a clear video image even when shooting in poor light. Flying erase head, hi-fi monaural sound, titler, A/V dubbing, wireless remote. With accessories. 4 1/2 x 4 3/8 x 6 7/8". 1.8 lbs. (TSP) 16-858 899.00

Extra-Life Battery. Available on special order (CMC). 16-2311 49.95

Remote Pause Control. (CMC) 16-2312 34.95

Wide-Angle/Telephoto Lens Kit. (CMC) 16-2313 99.95

Lens Filter Kit. (CMC) 16-2314 39.95

Free Arm Accessory Shoe. (CMC) 16-2315 54.95



Get the picture others miss! Capture more detail, emotion and expression with 16x digital power zoom.



Wireless Remote lets you get in the picture



NEW! Memorex VHS-Compact Model 155. Palm-sized for shooting ease, plays back on any VHS VCR for convenience. Fully automatic focus, color, exposure and shutter speed, plus 8x zoom with macro, 1-lux low-light sensitivity, flying erase head, A/V dubbing and digital fader. DC video light, wireless remote, VHS cassette adapter, accessories. 4 5/8 x 3 5/8 x 8 1/8". 1.7 lbs. (TSP) 16-856 899.00

Wide-Angle/Telephoto Lens Kit. Available on special order (CMC). 16-2307 99.95

RF Adapter. (CMC) 16-2308 39.95

Lens Filter Kit. (CMC) 16-2309 29.95

Extra-Life Battery. (CMC) 16-2310 49.95

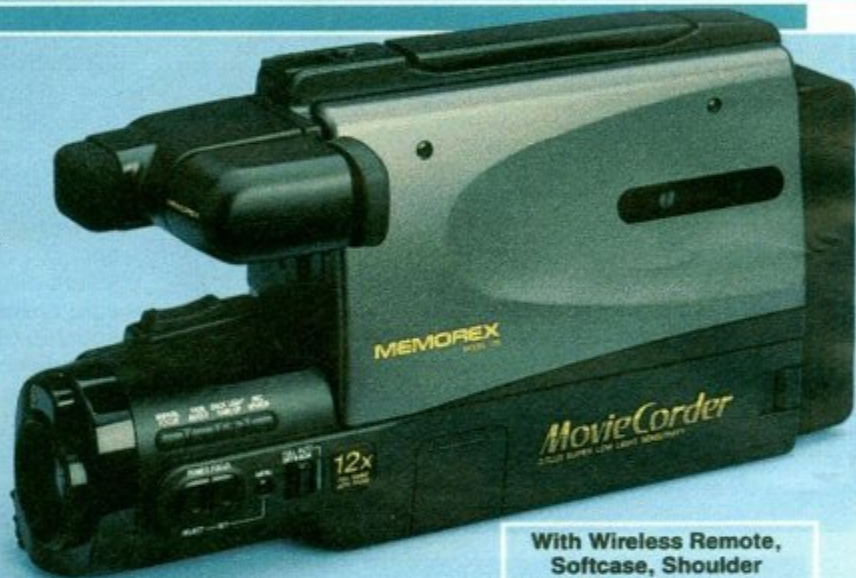

NEW! Memorex VHS Model 128. Our smallest, lightest full-size VHS ever, with 12x continuous zoom and astounding 0.7-lux extra-low-light sensitivity. One-touch full auto system, flying erase head, A/V dubbing, fader, remote, accessories. 7 1/8 x 3 x 12 3/4". 3.3 lbs. (TSP) 16-828 899.00

Remote Pause Control. Available on special order (CMC). 16-2300 19.95

Step-Up Ring. 43mm to 46mm. (CMC) 16-2301 4.95

Lens Filter Kit. (CMC) 16-2302 29.95

Extra Battery. (CMC) 16-2303 44.95

DC Adapter/Charger. (CMC) 16-2304 79.95

With Wireless Remote, Softcase, Shoulder Strap, Battery, AC Adapter/Charger

 Deluxe Hardcase. Foam padded. 16-2003 ... 79.95	 Softcase. 16-2011, 49.95 Minicase. 16-2012, 39.95	 15-Watt Video Light. 16-2010 79.95	 FM Wireless Microphone System. 32-1226, 69.95	 Super-Unidirectional Mike. 16-2008 ... 69.95	 Accessory Dual Mount. 16-2007 4.95
 Camcorder Cleaner/Care Kit. 16-2004 4.95	 Replacement for Camcorders 12V Battery. 23-187, 39.95 AC Chgr. (CMC) 17-610, 54.95	 VHS Battery. 23-183, 39.95 8mm. 23-184 19.95	 Extra-Capacity VHS Battery. 23-186 39.95	 Fluid-Head Tripod. Weighs only 4 1/4 lbs., yet is super-sturdy to give movies a steady, professional look. Adjustable tilt and pan tension, geared column. 61" extended, 24" collapsed. 16-2009 89.95	

A visual feast! TVs and monitors

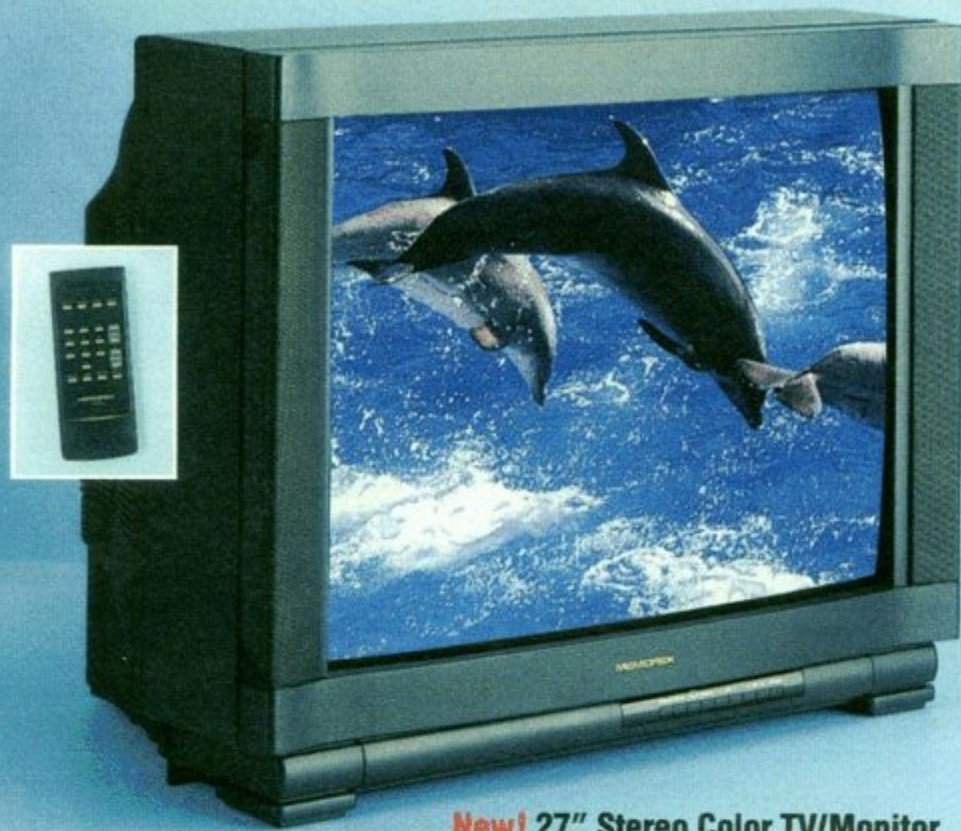

New! 27" Stereo Color TV/Monitor

Memorex TC-2700. Our biggest and best! High-contrast flat/square screen, MTS stereo-TV sound with second audio program (SAP), cable-compatible 179-channel tuner, on-screen displays. A/V in/out jacks. UL listed AC. Remote requires 2 "AA" batteries. (TSP) 16-280 599.95



NEW! Memorex TC-1004 20" Stereo Color TV/Monitor. Flat/square screen, MTS stereo and SAP, cable-compatible 179-channel tuner, on-screen displays. UL listed AC. Remote requires 2 "AA" batteries. (TSP) 16-254 369.95



Memorex TC-193 13" Color TV/Monitor. Features a cable-compatible 122-channel tuner, direct A/V inputs and on-screen displays. UL listed AC. Remote requires 2 "AA" batteries. (TSP) 16-229 249.95

Memorex 9" Portable Color TV/Monitor. Enjoy it at home, in your van, RV or boat. Plays on AC or 12VDC with included cord. Recessed carry handle. UL listed AC, 12VDC neg. gnd. (TSP) 16-244 299.95

NEW! Memorex 5" Portable Color TV/Monitor. Plays on AC, vehicle DC or batteries. Carry handle, A/V inputs, 12VDC cord. UL listed AC adapter, 12VDC neg. gnd. (or 9 "D" batteries, extra). (TSP) 16-123 249.95



NEW! Memorex TC-1014 19" Color TV/Monitor. High-contrast screen, cable-compatible 179-channel tuner, on-screen displays. UL listed AC. Remote requires 2 "AA" batteries. (TSP) 16-263 .. 299.95



3 1/2" B&W Portable TV. Ideal for desk or night table. Convenient Adjusta-tilt™ stand, removable battery pack, built-in Ni-Cd charging circuit, carry case. UL listed AC adapter (or 6 "C" batteries or DC adapter, extra). (TSP) 16-122 99.95

4 1/2" "Everything" B&W Portable. This AM/FM stereo cassette with built-in TV features dual 4" speakers, stereo headphone jack and auto-level recording. Monoaural mike jack. UL listed AC (or 8 "D" batteries or DC adapter, extra). (TSP) 16-119 129.95

5" B&W Portable. Perfect on a countertop, under a cabinet, in van, boat or RV. Plays on home AC or on vehicle DC with included cord. Mounts under cabinet with swivel bracket, slips out for portable use. UL listed AC or 12VDC neg. gnd. 16-121, 79.95



Digital-Tuning Pocket LCD Color TVs

NEW! Memorex 2.2" Pocket TV. Telescoping antenna, jacks for earphone and external antenna. Only 5 1/2 x 3 1/4 x 1 3/8". (TSP) 16-162 129.95

Memorex 2.7" Pocket TV. As above, with A/V inputs for use as portable monitor. Only 5 1/2 x 3 7/16 x 1 7/16". (TSP) 16-163 199.95

Each requires 4 "AA" batteries (or AC or DC adapter, extra).

Stereo satellite TV offers more! 200 channels plus!

Enjoy more movies, more sports, more music and more information than cable TV offers, plus 80 crystal-clear satellite radio channels. Satellite TV makes your home A/V system a true "window to the world" for the family.

Home Satellite System. A vast variety of programming plus real convenience. Just select a desired channel by remote from the on-screen display—the Memorex™ receiver does the rest, auto-positioning the 9-foot dish for best reception. Built-in timer lets you program a channel for recording by your VCR while you're away. You can even black out unwanted channels with parental lock. Engineered for do-it-yourself installation, or you can opt for professional installation. Upgradable to Ku-band.
Complete C-Band System 1995.00



Exclusively from our Satellite Shack™



SAVE! Exclusive Descrambler/Programming Offer for Memorex Owners. Satellite Source, a major supplier of satellite programming, is offering owners of Memorex receivers the VideoCipher® II Plus descrambler module plus a full year of programming for one low price. Your money-saving package includes channels such as CNN, A&E, Discovery, USA, Lifetime and The Nashville Network, plus options for special-interest networks and premium channels. You'll save big compared with the rising cost of cable, and get movies and videos in *stunning digital stereo* that cable doesn't provide! **Call TOLL-FREE for details: 800-477-1234** 9 a.m.-1 a.m. ET, Mon.-Sat. VideoCipher® II Plus is a registered trademark of General Instruments Corp.

These Components Available Separately for Upgrading Existing Systems

- | | |
|--|--|
| Memorex SR 2014 C/Ku Band Receiver. (TSP)
16-2511 799.95 | Advanced 45° LNB. 950-1450 MHz output.
16-2512 179.95 |
| 9-Foot Perforated Sectional Antenna. With horizon-to-horizon motorized mount. 16-2508, 1299.95 | Feedhorn. 16-2510 99.95 |

Security Alarm

Loud buzzer sounds if cable to dish antenna is cut or disconnected. Use alone or with a home security panel. Connects indoors at receiver. UL listed AC. Backup requires 9V battery. **49-441 . . . 29.95**



20 dB Inline Coax Amplifier

Perfect for satellite TV systems, UHF-TV and scanner radios. Boosts signals in 430-1450 MHz range—helps cut loss from long cable runs. "Bullet" amp is easy to install inline near the antenna. VHF pass-through. With DC block module and power injector. 75 ohms. UL listed AC. **15-1115 29.95**



Accessories to Enhance Your Satellite System

- Available on special order (CMC). All items delivered to your nearby Radio Shack store, with no extra charge for shipping or postage.
- | | |
|--|---------------|
| 100-Foot Cable Extension. 16-2316 | 99.95 |
| 50-Ft. Cable Extension. 16-2317 | 59.95 |
| Ku-Band LNB. 16-2318 | 199.95 |
| Terrestrial Interference Filter. For 16-2511. 16-2319 | 199.95 |
| Two-Way Signal Splitter. 950-1450 MHz. 16-2320 | 7.95 |
| Four-Way Signal Splitter. 950-1450 MHz. 16-2321 | 9.95 |
| C/Ku Feedhorn. 16-2322 | 169.95 |

Escape the remote jungle with a single handy control



(1)



(2)



(3)



(4)



(5)

(1) NEW! Preprogrammed 3-in-1 Easy Remote. This is the one you've been waiting for! Makes it a snap to control the three most common video components—TV, cable box and VCR—because it's pre-programmed. You just enter a 3-digit code from the included list for each of the components. Oversize buttons are perfectly positioned for convenience. Extra-powerful infrared beam. Requires 4 "AAA" batteries. **15-1906 29.95**

(2) Realistic® Model 150 4-in-1. Programmable—learns and reproduces commands of up to four remotes. Nine VCR keys, volume, channel scan. Requires 4 "AAA" batteries. **15-1902 49.95**

(3) VCR Plus™ Instant Programmer. Makes programming your VCR a snap! Just find the code number of the program you want to record in your TV listings. Enter that number into VCR Plus and point it at your VCR. Requires 4 "AAA" batteries. **15-1920, 59.95**

(4) Preprogrammed 4-in-1 Remote. No complicated setup—just enter a 3-digit code from the included list for each of up to four components. Works with Radio Shack brands and many others. Requires 4 "AAA" batteries. **15-1904 39.95**

(5) NEW! Preprogrammed 6-in-1 Remote. Controls six audio/video components, also works with Plug 'n Power remote modules to control lights and appliances. Requires 4 "AAA" batteries. **15-1905 59.95**



Video Dubbing Processor

Preserves picture detail and sound quality normally lost during duplication. Connects VCR to VCR for superior dubbing of personal tapes, or camcorder to TV for improved viewing. Features separate continuously variable audio gain and video enhancement controls to ensure that your copies sound and look good. UL listed AC adapter. **15-1955 24.95**



Audio/Video Control Center

Ends the hassle of swapping audio and video cables—with the flip of a switch you can connect your TV or VCR to your camcorder, video disc player, satellite receiver or second VCR. Handles baseband (separate video and audio) signals. Stereo compatible. Four inputs, one output. RCA phono jack connectors. **15-1956 24.95**

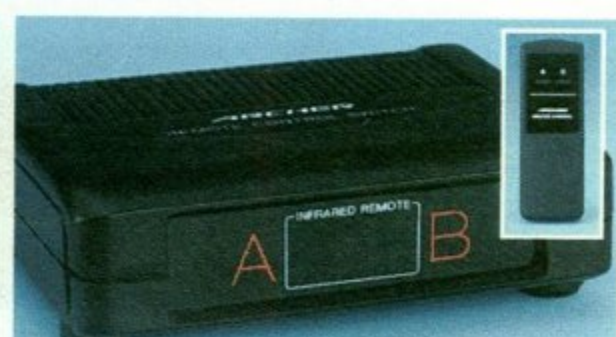

Remote Video A-B Switch

Wireless remote lets you plug in two 75-ohm video sources, then switch between them without getting up from your chair. Switch between any two of VCR, laser disc, satellite, cable or broadcast TV—no swapping cables or keying-in long remote sequences. High isolation between sources. Remote requires 2 "AA" batteries. UL listed AC. **15-1957 39.95**

Upgrade your video system with Archer® electronics

Take control of your entire audio/video system with these versatile, inexpensive accessories. Choose from a great line-up of selectors and amplified selectors, processors, enhancers and distribution systems.

Not sure what you need? Our sales staff will help you determine which model is right for your particular needs. And they'll make sure you get the right cables and connectors to make setup fast and easy.

Come in and see what a difference Archer can make in your viewing enjoyment!



Wireless Video Distribution System

Watch what you want where you want! Wireless system lets you watch a program from your VCR, laser disc, cable box, satellite receiver or security camera on a TV in another room. Transmitter installs between video source and main TV, sends signal to main TV and to receiver unit plugged into a TV in another room. Has two transmitting frequencies for best possible results, plus antenna pass-through and switchable base-band/RF inputs. UL listed AC. (TSP) **15-1958** **99.95**
Extra Receiver. Available on special order (CMC). **15-2301** **49.95**

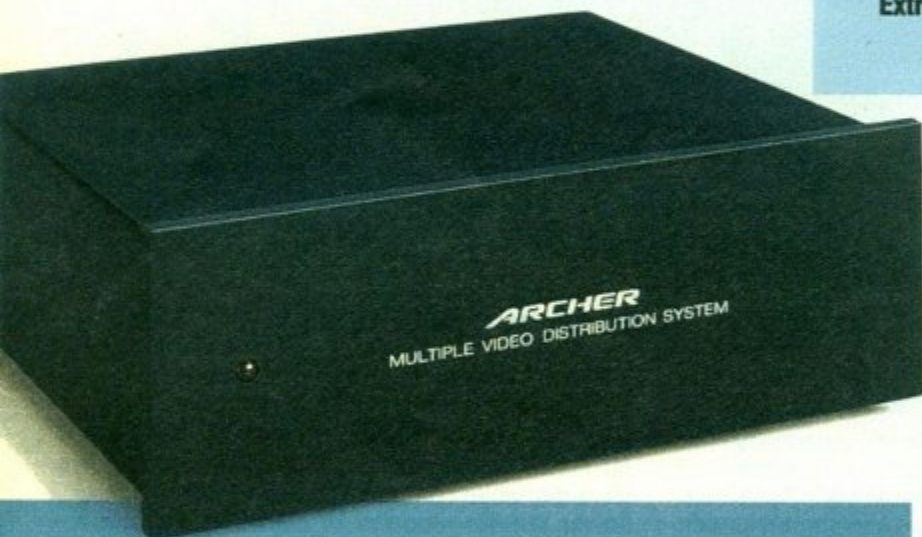

Multiple Video Distribution System Feeds Three TVs

Now every TV can be tuned to a different video source included in your system! Sends signals from your cable box, VCR and satellite system or antenna to every TV in the house—viewers can choose a different source and select what they want to watch simply by using the TV's tuner. A single coax cable runs from each of the three outputs to up to three TV sets, and you can add splitters to hook up even more TVs. All outputs are amplified for best reception, even in distant rooms. Works with all standard TV receivers. Easy hookup with coax cable, or you can use existing coax in prewired homes. LED "on" indicator. UL listed AC. (TSP) **15-1290** . . **54.95**



70-Channel Cable-TV Converter Box

Don't rent a cable company box—buy your own. Our converter works with virtually all cable systems, and can pay for itself in installation and rental fee savings in no time. Features full-function wireless IR remote control with scan or direct-entry tuning, last-channel flashback to return to previous channel and 90-minute sleep timer to automatically turn off the converter. Fine-tuning feature lets you adjust converter to accurately tune frequencies in any cable system. Channel 3 or 4 output. With patch cable and splitter. Remote requires 9V battery. (TSP) **15-1287** . . . **99.95**



Complete VCR Multiplying System

It's like having a VCR in every room! Inexpensive system lets you share a single VCR with a second TV, or use VCR on one set while viewing a TV program on the other. There's no hassle of moving or reconnecting your VCR. You can even use your existing IR remote to control your VCR from any room that has an Archer multiplier receiver—even though the VCR is in another room. System includes transmitter, receiver, cables and ultrathin connecting wire for easy hookup in minutes. UL listed AC. **15-1953**, **49.95**
Extra Receiver. Available on special order (CMC). **15-1954** **29.95**

**Great audio and
video made clear**



Dolby Surround™ Decoder/Amplifier. Decodes surround-sound channel on stereo laser discs, video tapes and many stereo-TV broadcasts, when connected to line-level stereo outputs. 20 watts total power. UL listed AC. (TSP) 15-1279 129.95



New! Video Enhancer/Audio Mixer

Now you can add professional-sounding narration and background music to the soundtrack of your home videos while enhancing the quality of the video image. Controls: video enhance/bypass, audio mixing, music mixing, microphone mixing, master audio. Inputs for CD/cassette, camcorder/VCR and microphone. VCR/TV output. 1/4" headphone jack. With dubbing cables. UL listed AC. (TSP) 15-1961 59.95



4-in-1 Video Processor. Variable A/V enhancer improves dubs. Comparator wipe displays before/after enhancements on split screen. Stereo synthesizer. Fader for synchronized A/V fade-in/outs. UL listed AC. (TSP) 15-1276 129.95

New! Amplified 4-Input, 2-Output A/V Selector

Stop battling a maze of cables when you want to change your TV's or VCR's input source. With this compact control center you can route A/V signals from any of up to four sources—such as satellite/cable/antenna, videodisc player, VCR and camcorder—to a TV for viewing, plus a VCR for recording or a second TV. Push a single button to choose the combination you want. Baseband design cuts RF interference between inputs. RCA-type phono connectors. UL listed AC adapter. 15-1951 39.95

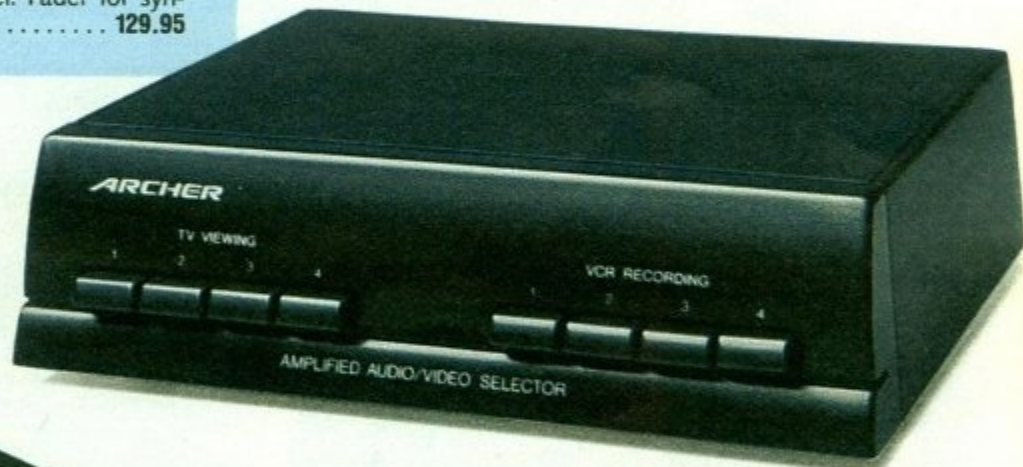

Amplified 5-Input, 3-Output Video Selector

Simplify your system! This versatile control center ends cable swapping and simplifies video dubbing—lets you connect up to five video sources for viewing or recording with any combination of three TVs/VCRs. Just push a button to select source and output. Inputs for antenna, cable, VCR and two aux sources. Three TV/VCR outputs. Three built-in amplifiers eliminate almost all signal loss caused by switching and splitting of the TV signals. Signal is amplified 12 dB at antenna/cable-TV inputs for a superb picture. Use with TV antenna, cable TV, VCR, videodisc player or computer. High isolation helps prevent interference between inputs. 75-ohm connectors. UL listed AC. (TSP) 15-2100 79.95



5-Input, 2-Output Video Selector

Add versatility to your video system and eliminate cable-swapping! End the hassle of battling a maze of cables when you want to change the input source on your TV or VCR. Provides real convenience and flexibility—two banks of pushbutton controls let you select sources independently and record from any source, even from VCR to VCR. Directs RF signals from up to five different inputs to a TV for viewing, plus a VCR for recording or a second TV. Inputs for TV antenna, cable TV and VCR, plus two aux inputs. 75-ohm inputs/outputs—use with TV antenna, cable TV, VCR, video disc player or computer. 15-1266 39.95

You can really see the difference with SUPERTAPE

Our exclusive SUPERTAPE® brand brings out the best from your VCR or camcorder, whatever its format. Our VHS, VHS-C, 8mm and Beta cassettes deliver more vibrant colors, increased picture detail and superb audio, play after play.



8mm Video Cassettes

HG-120. Our finest! High-grade metal coating provides up to a 25 percent improvement in picture and sound quality. 44-452, 8.99
MP-120. Metal-particle formula gives you superb video clarity. Up to four hours of recording time at VCR's LP speed. 44-451 .. 7.99



For VHS-C Camcorders

TC-20 MHG. Master high grade is ideal for recordings you intend to keep or duplicate. 44-431, 5.99
TC-20 SHG. Super high grade. True-to-life colors, even after many recordings and playbacks. 44-430 4.99

SUPERTAPE for VHS and Beta Recorders

VHS T-120 Cassette. High-density formula delivers excellent color stability. Precision low-friction housing. Up to six hours recording time at LP speed. 44-400 3.99
Beta L-750 Cassette. This long-life particle formulation is ideal for multiple recordings and playbacks. Make this your timeshifter tape. Up to 4½ hours recording time at LP speed. 44-475 4.99
VHS T-120 HIGH GRADE Cassette. Exceptional resolution and color reproduction even at slow speed. 44-410 5.99
Beta L-750 HIGH GRADE Cassette. Incomparable recordings. Delivers quality you'll continue to notice, even after many playbacks. 44-480 5.99
VHS T-120 PRO HI-GRADE Cassette. The right choice for master recordings. Premium fine-particle formulation reduces dropouts while improving detail and color purity. Supplied in a professional-quality protective storage box. 44-411 8.99
NEW! Super-VHS T-120 MLC Cassette. Multilinear particle construction provides unsurpassed performance. Enjoy the more accurate color and extra resolution that the S-VHS format is famous for. Up to two hours of recording time. 44-413 12.95
VHS T-30 PRO HI-GRADE Camcorder Cassette. Engineered to meet the demands of commercial applications, and priced right for everyday use, too. Premium fine-particle formulation. Up to 1½ hours recording time. 44-412 6.99



Wear-Saving Video Cassette Winders

(1) **VHS Rewinder/Fast-Forwarder.** Frees VCR for use while you rewind or forward another tape. Saves wear on VCR's motor and heads. Requires 4 alkaline "C" batteries or AC adapter. 44-1140 29.95
 AC Adapter for Fig. 1. UL listed. 273-1455 7.95
 (2) **Deluxe VHS/Beta Rewinder/Fast-Forwarder.** With end-of-tape auto-stop to protect your video cassettes. Includes UL listed AC adapter. 44-1141 41.95
 Car DC Adapter for Fig. 2. 270-1533 3.99



Bulk Tape Eraser

Works fast, erases completely. Perfect for video and audio tapes, including metal audio tape. UL listed. 44-233, 31.95



Deluxe Cover

Quilted material provides excellent protection for your VCR. About 4 x 17½ x 14". 44-1183 9.99



Cleaners to Keep Your VCR or Camcorder Working Like New

(1) (2) **Automatic.** Our best. Wet nonabrasive system cleans heads, capstans, pinch rollers and guides. With fluid. For VHS, 44-1148. For Beta, 44-1149 Each 12.95
 (3) **VHS Wet/Dry System.** Fast, safe and effective. 44-1143 9.99
 (4) **8mm VCR/Camcorder Cleaner.** Nonabrasive wet system. 44-1144 10.95
 (5) **Economy VHS Cleaner.** Just load and play. 44-1146 6.95
 (6) **VCR Cleaning Kit.** For all types of VCRs and camcorders. Includes brush, mirror, probe, glove and a bottle of nonabrasive cleaning fluid. 44-1157 9.95

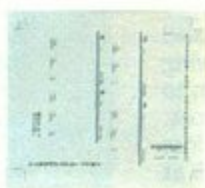

Relabeling Kit

Gives collection a neater look, makes tapes easier to find. 10 adhesive label sets. For VHS or Beta tapes. 44-1103 1.59



Stackable Storage

Holds six VHS or Beta tapes. Easy to expand as collection grows—just add more modules. 44-1102 Each 4.99



Library Albums

Individual book-style storage cases help you organize and protect VHS or Beta tapes. 44-1105 Pkg. of 3/2.99



Our Finest Cassettes! Digital-Ready Metal Type IV

Designed for recording on metal-capable decks and playable on all cassette equipment. Provides greater high-frequency headroom, so it's excellent for personal taping from compact discs. Precision 5-screw housing reduces wow and flutter. Nonabrasive cleaning leader assures optimum performance on every playback. Each is supplied in a protective hinged storage box with an index card.

Type	Total Recording Time	Cat. No.	Each			
			1-2	3-11	12-49	50-499
MIV-60	60 Minutes	44-960	4.99	4.49	3.99	3.49
MIV-90	90 Minutes	44-961	5.99	5.39	4.79	4.19

Premium MII Type II Metal for Hi-Bias Decks

A superb metal tape for recording on decks with Chrome/Hi-bias (70 μS) switch position. Plays on all cassette equipment. Exceptionally wide dynamic range and much lower noise. Each has a nonabrasive cleaning leader, 5-screw housing and a hinged storage box with index card.

Type	Total Recording Time	Cat. No.	Each			
			1-2	3-11	12-49	50-499
MII-60	60 Minutes	44-950	3.99	3.59	3.19	2.79
MII-76	76 Minutes	44-952	4.49	4.04	3.59	3.14
MII-90	90 Minutes	44-951	4.79	4.31	3.83	3.35
MII-100	100 Minutes	44-953	4.99	4.49	3.99	3.49

Digital-Ready HD Chrome-Equivalent Type II

For recording on decks with Chrome/Hi-bias switch position. Plays on all cassette equipment. Captures loudest and softest passages while reducing noise. Precision 5-screw housing. Nonabrasive cleaning leader. Hinged storage box with index card.

Type	Total Recording Time	Cat. No.	Each			
			1-2	3-11	12-49	50-499
HD-46	46 Minutes	44-942	2.39	2.15	1.91	1.67
HD-60	60 Minutes	44-940	2.49	2.24	1.99	1.74
HD-76	76 Minutes	44-943	2.79	2.51	2.23	1.95
HD-90	90 Minutes	44-941	2.99	2.69	2.39	2.09
HD-100	100 Minutes	44-944	3.69	3.32	2.95	2.58

Premium XR Extended-Range Ferric Type I

Audiophile quality at a bargain price! For recording and playback on all cassette equipment. Delivers optimum performance at normal bias for greater detail. Precision 5-screw housing. Nonabrasive cleaning leader. Hinged storage box with index card.

Type	Total Recording Time	Cat. No.	Each			
			1-2	3-11	12-49	50-499
XR-46	46 Minutes	44-920	1.39	1.25	1.11	.97
XR-60	60 Minutes	44-921	1.49	1.34	1.19	1.04
XR-90	90 Minutes	44-922	1.99	1.79	1.59	1.39
XR-120	120 Minutes	44-923	2.79	2.51	2.23	1.95



Carrying Cases

- (1) For Personal Stereo Player. Adjustable strap. 44-689 .. 7.95
- (2) Universal Case. For stereo or up to 10 tapes. 44-681 ... 9.95



Padded Tape Cases

- (1) Protects up to 30 audio tapes or 24 8mm tapes. 44-686, 14.95
- (2) Stores up to 24 audio tapes or 12 8mm tapes. 44-635, 8.95



Universal Tape Case

Protect your tape collection. Stores up to 60 boxed, 96 unboxed audio tapes or up to 48 8mm tapes. 44-679 .. 18.95



Audio Cassette Tray

Organizes 15 cassettes. Tinted cover keeps out harmful dust and moisture. Perfect for your vehicle. 44-665 3.99



Audio Tape Module

For 10 boxed or 16 unboxed tapes. Easy to add on. Modules lock-on horizontally or vertically. 44-685, Each 2.69

High-performance audio tape made by us in the USA

In tests made by a leading audio magazine, SUPERTAPE outperformed many other famous-maker audio cassettes. Compare its true-to-life sound and our low prices, then stock up for all of your recording needs.



LN Low-Noise Ferric Type I Cassettes

High-flux-density oxide formula delivers high output with low noise. For recording and playback on all cassette equipment. Precision housing cuts wow and flutter.

Type	Total Recording Time	Cat. No.	2-Pack
LN-30	30 Minutes	44-901	1.69
LN-60	60 Minutes	44-902	1.99
LN-90	90 Minutes	44-903	2.39
LN-120	120 Minutes	44-904	3.49



Open-Reel Concertape® and Tape Reels

Open-Reel Tape. No better value for general purpose recording. Heavy-duty 1 mil Polyester base is super-strong, resists stretching and humidity, delivers long life at low cost. 1800 feet, 7" reel. 44-1018 2.99

Tape Reels. Ideal for replacing damaged and warped take-up reels on open-reel recorders. Plastic. Included storage box has a convenient index and timing chart. 5" Reel. 44-278 1.69
7" Reel. 44-279 1.89

Accessories Designed to pamper your recording equipment and tapes



Bulk Eraser

Get your tapes erased in a hurry! Easy to use. (Not for metal tapes or video cassettes.) UL listed AC. 44-232 19.95



Demagnetizer

Just load it like an ordinary cassette! Works fast and "tells" you when it's done. With indicator and battery. 44-1165 .. 10.95



Lighted "Demag"

The lighted 3 1/2" probe helps you easily find and demagnetize tape heads. UL listed AC. 44-207 15.95



(1)

(2)



(4)

(5)

(6)

Audio/Video Tape Equipment Cleaner Kits

- (1) "Pro" Video Cleaning Kit. 44-1115 4.99
- (2) Budget Cleaning Kit. 44-1112 3.89
- (3) "Pro" Cleaner Spray. For all tape equipment. 44-1114, 4.99
- (4) Pro-Style Tape Head Cleaning Solvent. 44-1113 3.59
- (5) Standard Tape Head Cleaning Solution. 44-1010 99¢
- (6) Cleaner/Lube Kit. For tight spots. 44-217 2.59



Head Cleaning and Demagnetizing Kits for Cassette Players

- (1) Head Cleaner Kit. Helps extend tape and player life. Cassette works with cleaning fluid to clean entire tape path. 44-1162 2.89
- (2) Head Cleaner/Demagnetizer Kit. Ideal for all types of cassette players and answering machines. Includes demagnetizing cassette, probe, mirror and cleaning solution. 44-1167 5.95
- (3) Dry Head Cleaner. Non-abrasive tape works without cleaning solution to help restore sound clarity to your player. 44-1160 1.99
- (4) Liquid Deck Cleaner. The felt pads move back and forth to gently scrub the head, roller and capstan clean. Includes 1/2-oz. bottle of cleaning solution. 44-1116 3.99

Cleaning Swabs

- (1) Foam. Ultrathin. 44-1001 ... Pkg. of 10/2.49
- (2) Foam. Dual-tipped. 44-1094 ... Pkg. of 10/2.39
- (3) Cotton. Dual-tipped. 44-1093 .. Pkg. of 100/2.19

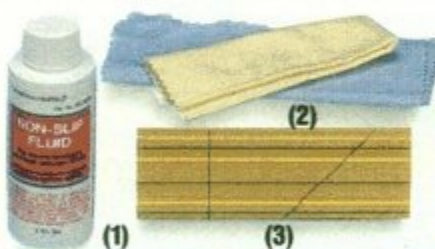

(1)

(3)

Tape Accessories

- (1) Non-Slip Solvent. For belts, idlers. 44-1013 99¢
- (2) Equipment Cleaning Cloths. 44-1088 Pkg. of 4/2.19
- (3) Edit Block. 44-224 .. 3.99



Cassette Tape Splicer. 44-214 6.99



(1)

(2)

(3)

- (1) Splicing Tape. 100" rolls. 7/32" wide, 44-1125. 3/8" wide, 44-1126. 1/8" wide, 44-1128 Each 89¢
- (2) Leader Tape. 200" rolls are 7/32" wide. 44-1131 99¢
- (3) Sensing Tape. 100" roll. 44-1155 3.39



Cassette Shell

Replaces damaged housing. With 24" of leader and instructions. 44-626 1.19



Cassette Boxes

Hinged boxes store and protect audio cassette tapes. 44-611 Pkg. of 3/1.39



Index Labels

Self-adhesive. Six each of red, yellow, blue and green. 44-621 Pkg. of 24/99¢



Index Cards

Keep track of music or data on tapes. Fits standard cassette box. 44-623, Pkg. of 20/1.29



Cassette Mailers

Excellent for demo tapes. Comply with all first-class postal regulations. 44-608 ... Pkg. of 3/99¢



Budget Mailers

Heavy-duty cardboard. Meet all first-class postal regulations. With labels. 44-632 ... Pkg. of 6/89¢



Foot Switch

Hands-free remote operation of recorders. Ideal for typing from dictation. 44-610 3.69



Phone Pickup

For recording personal calls. (May be incompatible with some electronic phones.) 44-533 .. 3.29



Car AC Adapter

Saves on batteries and works with most portables. Delivers 6 or 9 volts. 14-844 6.99

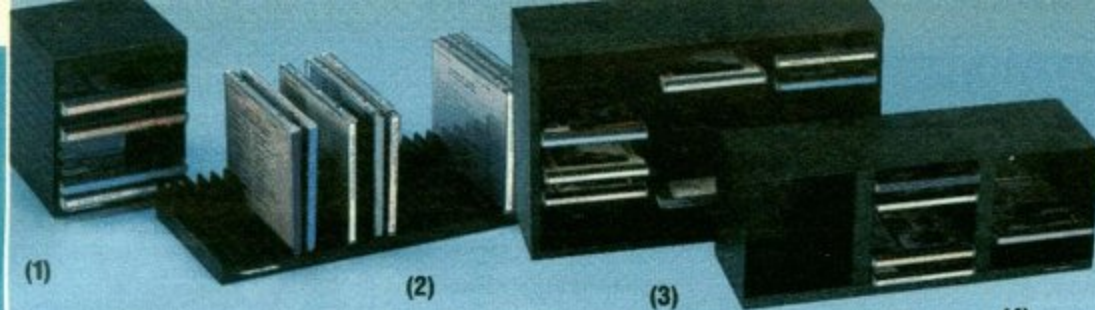

Keep Your Discs Organized With a CD Storage Rack

- (1) Organize and store up to 10 compact discs in their jewel boxes. 42-214, 5.95
- (2) Lets you keep up to 25 CDs in a vertical position for easy access and protection. Attractive and durable molded construction. 42-215 5.95

- (3) **NEW!** Holds up to 45 CDs! Attractive, contemporary case has space for double-disc sets, too. Horizontal design makes titles easier to read. 42-219 24.95
- (4) Holds up to 36 CDs. Molded construction, rubber feet. 42-216 12.95

Radio Shack is your source for everything in phono cartridges and CD/phono care



Protect and Maintain Your CDs With These Accessories

- (1) **CD Carry Bag.** Holds your CD portable plus five compact discs in separate compartment. With shoulder strap. 42-217 17.95
- (2) **NEW! Scratch 'n Fix.** In just a few moments it fills light scratches on CDs so players can read disc and stop "skipping". 42-127 9.95
- (3) **CD Jewel Boxes.** Replaces broken CD jewel boxes. 42-122 ... Pkg. of 2/2.99
- (4) **CD Player Lens Cleaner.** Safe and easy to use with home or portable players. (Not for magazine-type changers.) 42-123 14.95
- (5) **CD Cleaning System.** Removes dust, dirt and oil from CDs. 42-116 .. 12.95
- (6) **NEW! Disc Stick™.** Ideal for portable use! A CD cleaning system that you can take with you anywhere. Easy to use. 42-141 4.95
- (7) **Replacement CD Cleaner Fluid.** One fluid oz. 42-126 2.59
- (8) **Budget CD Cleaner.** With base, pad and fluid. 42-113 4.95

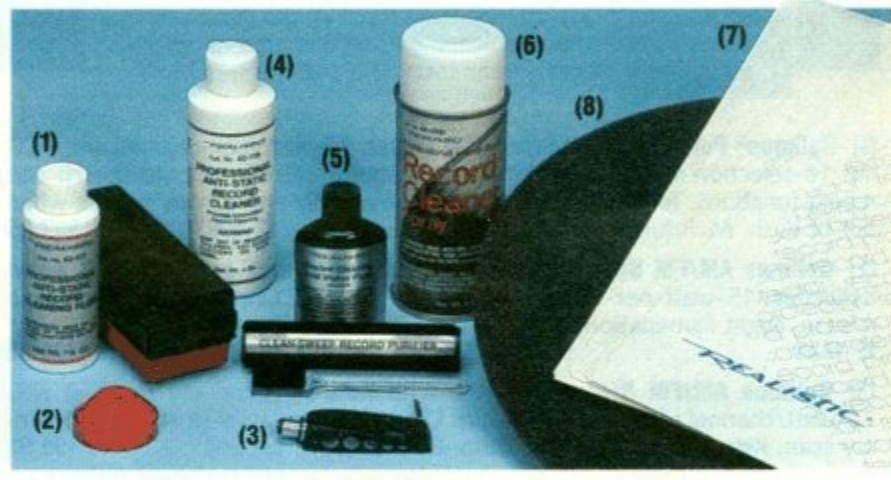

Get the Most From Your Turntable

- (1) **Pro Record Cleaner.** Velvet-surfaced brush, 2 oz. cleaning fluid. 42-117, 7.95
- (2) **45-RPM Adapter.** Play 45s on LP spindles. 42-120 69¢
- (3) **Headshell Replacement.** Low-mass design. Fits most S-shaped phono tonearms and accepts popular cartridges. With hardware. 42-2752 5.99
- (4) **Record Cleaning Fluid.** Four-ounce bottle. 42-119 1.99
- (5) **Record/Stylus Cleaner.** Cleans records and stylus tip. 42-140 4.99
- (6) **NEW! Pro Record Cleaner Spray.** Removes dust and dirt. Prolongs life of needle and records with regular use. 42-2501 2.99
- (7) **Laser Disc/LP Sleeves.** Replacement sleeves to help protect LPs and 12" laser video discs. 42-132 Pkg. of 10/2.79
- (8) **12" Foam Turntable Cushion.** Helps protect LPs from sliding and scratching on hard turntable surfaces. 42-361 1.19



Phono Cartridges

- (1) **V15 Type RS.** Our best! 5-30,000 Hz frequency response, 30 dB channel separation. 42-2800 79.95
- (2) **R25XT.** 20-20,000 Hz. 2.5-3.5 gram tracking. 42-2777 19.95
- (3) **R47XT.** 20-20,000 Hz. 1.75-2.25 gram tracking. 42-2778, 26.95
- (4) **RXP3.** P-mount design, 1.25 gram tracking. 42-2790 29.95

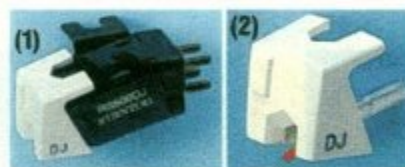

Realistic/Stanton

- (1) **RS500DJ Cartridge.** For broadcast and DJ use. 42-2794 ... 29.95
- (2) **R500DJ Stylus.** 42-2793, 19.95

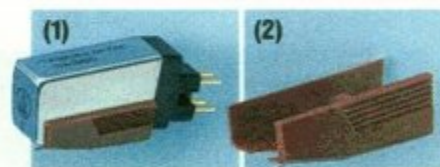

Realistic/Audio Technica

- (1) **RX 1500 Cartridge.** Diamond elliptical. 1-1.5 g. 42-2775 ... 29.95
- (2) **RT1500 Stylus.** 42-2776, 19.95



Diamond Replacement Styli

- (1) **R3X.** For R25, M71, M75ECS series. 42-2780 14.95
- (2) **R5X.** For R47, M70, M75 series. 42-2781 17.95
- (3) **RS3P.** For RXP3, M92E, M104E. 42-2791 19.95



Cartridge and Stylus Hotline!

Our "Hotline" Service can deliver most replacement styli and cartridges to your nearby Radio Shack fast! Hundreds of types available. If the type you need isn't on this page, we'll order it for you. Bring in your cartridge or stylus if you're not sure what you need. No extra charge!



Diamond Stylus Replacements

- (1) **RS-166.** For BSR cart. or stylus no. SC7H, SC8M, ST-16, ST-17, ST-21. 42-2892 ... 3.99
- (2) **RS-98.** Tetrad cart./stylus 51-54D, 61-64D, A1-A3, B-1-B-4, T5HD, 20HD. 42-2802, 3.99
- (3) **RS-127.** For Tetrad cart. or stylus 40-44D, 20-24D, C-01/2/3, T3, 30MD. 42-2841, 3.99

High-power in-dash car stereo players



NEW! Realistic® Pullout AM/FM Stereo/Auto-Reverse Cassette. Anti-theft! Take it with you or put in trunk for safekeeping. 13-watt/channel amp, 1/8" CD jack. Tuner stores stations automatically and retains presets when out of dash. Night illumination. (TSP) 12-1988, 179.95

- (1) **Optimus® Pullout AM/FM Stereo/CD Player.** 16-watt-per-channel amp. CD has 16-selection memory, random play to shuffle selections, auto-search and repeat functions. Tuner stores stations automatically and retains presets when out of dash. Multifunction display. Night illum. (TSP) 12-1987 359.95
- (2) **Optimus AM/FM Stereo Cassette With Auto-Reverse and Dolby™ B Noise Reduction.** 15-watt-per-channel amp, front-panel CD input jack. Key-off tape release. Night illumination. DIN-E. Was \$219.95 in '92 Catalog. (TSP) 12-1938 **New Low Price! 199.95**
- (3) **Optimus AM/FM Stereo Cassette With Auto-Reverse and Dolby B NR.** 22-watt/channel amp, remote-mount CD jack. Tuner auto-storage and memory scan. Key-off release. Night illum. DIN-C. (TSP) 12-1944 199.95
- (4) **Realistic® AM/FM Stereo Cassette With Auto-Reverse and CD Input Jack.** 15-watt/channel amp, front-panel jack for connecting portable CD player. Key-off tape release. Night illumination. DIN-E. (TSP) 12-1945 179.95
- (5) **Realistic AM/FM Stereo Cassette Auto-Reverse and 5-Band Equalizer.** 14-watt-per-channel amp, equalizer to customize frequency response. Key-off tape release. Night illumination. DIN-C. (TSP) 12-1949 159.95
- (6) **Optimus AM/FM Stereo Cassette With Auto-Reverse, Dolby B NR, Remote CD Input Jack.** 14-watt/channel amp. Key-off tape eject. Night illum. DIN-C. Was \$179.95 in '92 Catalog. (TSP) 12-1936 **New Low Price! 159.95**
- (7) **Realistic AM/FM Stereo Cassette With CD-Input Jack.** Sensational 15-watt-per-channel sound plus a front-panel 1/8" jack for connecting a portable CD player. Night illumination. DIN-E. (TSP) 12-1940 149.95
- (8) **Realistic AM/FM Stereo Cassette With Auto-Reverse.** 15-watt-per channel amp. Line-out jack. Night illumination. DIN-C. (TSP) 12-1946 149.95
- (9) **NEW! Realistic AM/FM Stereo Cassette With Seek and Scan.** 14-watt-per-channel amp. 30-preset tuner. Cassette has locking fast-forward, auto-stop, manual eject. Night illumination. DIN-C. (TSP) 12-1950 ... 129.95



(7)



(8)



(9)

INSTALLATION INFORMATION FOR OUR IN-DASH CAR STEREO EQUIPMENT

Sizes are stated Height x Width x Depth

PULLOUT - Fits the single rectangular dash opening in many late-model vehicles. The player slides out for safekeeping. Its mounting bracket stays in dash. The bracket requires a 2 1/8" -high by 7 1/4" -wide dash opening and a space of at least 2 1/8 x 7 1/4 x 6 7/8" behind the dash. Please compare these dimensions with your vehicle's dash opening and the space available behind dash.

DIN-E - This is the "flat face" chassis design that fits the single rectangular dash opening in many late-model vehicles. These players require a 2 1/8" -high by 7 1/4" -wide dash opening and a space behind the dash at least 2 1/8" high and 7 1/4" wide. The minimum depth required behind the dash varies by player model and is listed in the table below.

Player Model	12-1938	12-1940	12-1942	12-1945	12-1948
Depth Behind Dash	6"	5 5/8"	6 1/2"	6"	6 3/8"

DIN-C - These players require dash openings for two control shafts and an opening between the shafts at least 1 3/4" high by 4 3/16" wide for the player's nosepiece. Control shafts of these players adjust from 5 1/8" to 5 13/16" spacing. We include a trimplate and a trimmable rubber gasket for a good-looking fit in a wide variety of vehicles. The bodies of these players require a space of at least 2 x 7 1/16 x 6 3/8" behind the dash. Please compare these dimensions with your vehicle's dash opening and the space available behind dash.

MINI/UNIVERSAL - #12-1927 has control shafts that adjust 5 1/8" to 5 13/16". Requires a dash opening at least 1 11/16" high by 3 3/4" wide and space behind dash of 1 31/32 x 6 7/16 x 4 7/8".

GENERAL INFORMATION - All models include cable for two speakers, plug-in wiring harnesses with labeled leads, fuse, switched power lead for accessories (except #12-1927). CAUTION: High-power players require **ungrounded** speaker wiring, two wires to each speaker. Some vehicles may require dash modification. NOTE: Shaft spacing in most older domestic trucks is 6 3/16".

Super-value mobile stereo! 19 feature-packed models



Optimus CD-36 Under-Dash CD Player With 36-Watt Amp. No need to remove present in-dash stereo—this powerful player works with it or by itself. Line-out jacks and auto search. 2 1/16 x 6 7/8 x 7 3/16". Was \$349.95 in '92 Catalog. (TSP) 12-1941 **New Low Price! 249.95**

- (1) **Realistic AM/FM Stereo Cassette With Auto-Reverse.** Tuner stores strong stations automatically. Really handy when you drive in a different city—just push one button to set the 18-preset memory. Memory scan provides a brief sample of preset stations. Has line-out jacks for adding an external amplifier. DIN-E. (TSP) 12-1942 **149.95**
- (2) **Realistic AM/FM Stereo Cassette With Auto-Reverse.** Auto-reverse convenience and digital-electronic tuning for a price you might expect to pay for a strictly manual radio/cassette player. Night illumination. DIN-C. (TSP) 12-1943 **139.95**
- (3) **NEW! Realistic AM/FM Stereo Cassette With Pullout Anti-Theft Chassis.** Take this player with you when you leave vehicle, or store it in the trunk. Tuner stores strong stations automatically and retains preset stations when out of dash. Memory scan provides a brief sample of preset stations. Night illumination. (TSP) 12-1989 . . . **129.95**
- (4) **Realistic AM/FM Stereo Cassette With CD Jack.** Front-panel 1/8" jack lets you connect a portable CD player and enjoy it through your car system. Tuner has 30 presets and stores stations automatically. Night illumination. DIN-E. (TSP) 12-1948 **119.95**
- (5) **Realistic AM/FM Stereo Cassette With Seek and Scan Tuning.** Digital-electronic tuning and convenient seek and scan functions, now even a better value! Night illumination. Was \$129.95 in '92 Catalog. DIN-C. (TSP) 12-1939 **New Low Price! 99.95**
- (6) **Realistic AM/FM Stereo Cassette With Seek and Scan Tuning.** What a buy! You get excellent sound and extra-feature digital-electronic tuning at extremely low cost. Night illumination. DIN-C. (TSP) 12-1947 **99.95**
- (7) **Under-Dash Stereo Cassette Player.** Good sound and all the basic features in a compact size, only 1 11/16 x 5 1/2 x 5 1/2". 12-1984 **34.95**
- (8) **Mini-Size In-Dash AM/FM Stereo Cassette.** Designed to fit small spaces. Lighted dial. Cassette auto-stop to protect tapes. Mini/Universal size. (TSP) 12-1927 **59.95**



Below: The word "Auto" means that the feature is automatic. Stereo sep. refers to FM stereo separation in dB. Sens. indicates FM tuner sensitivity in microvolts. ASMS is cassette auto-search music system, a feature that helps you find selections quickly.

Cat. No.	Price	Amplifier					Tape						CD	Radio					FM Specs		Style		
		Watts/Channel	Bass & Treble	Line In/Out	Spkr. Fader	CD Jack	Loudness Control	Auto Reverse	Dolby NR	ASMS	Metal Cr02	Auto Stop		Locking FF/Rew.	Station Presets	Clock Display	Mono Stereo	Local/DX	Auto Seek	Auto Scan		Stereo Sep.	Sens.
12-1927	59.95	4																			30	4.0	Mini/Universal
12-1936	159.95	14	✓	Out	✓	✓	✓	✓	✓	✓	✓	✓	✓	12	✓			✓	✓	33	2.5	DIN-C	
12-1938	199.95	15	✓	✓	✓	✓	✓	✓	✓	✓	✓	✓	30	✓		✓	✓	✓	40	2.2	DIN-E		
12-1939	99.95	14	✓		✓								12	✓	✓	Auto	✓	✓	35	3.5	DIN-C		
12-1940	149.95	15	✓	✓	✓	✓							30	✓	Auto	✓	✓	✓	36	1.5	DIN-E		
12-1941	249.95	18	✓	Out									✓									Under Dash	
12-1942	149.95	5		Out	✓								✓	18	✓	✓	Auto	✓	✓	35	2.5	DIN-E	
12-1943	139.95	5			✓								✓	12	✓	✓		✓	✓	33	1.5	DIN-C	
12-1944	199.95	22	✓	✓	✓	✓	✓	✓	✓	✓	✓	✓	✓	30	✓		Auto	✓	✓	42	1.4	DIN-C	
12-1945	179.95	15	✓	✓	✓	✓	✓	✓	✓	✓	✓	✓	✓	30	✓		✓	✓	✓	42	1.4	DIN-E	
12-1946	149.95	14	✓	Out	✓		Auto	✓					✓	30	✓	Auto		✓	✓	38	2.2	DIN-C	
12-1947	99.95	5												12	✓	✓	Auto	✓	✓	36	1.8	DIN-C	
12-1948	119.95	4			✓	✓								30	✓	Auto	Auto	✓	✓	35	2.2	DIN-E	
12-1949	159.95	14	(EQ)	Out	✓								✓	30	✓	✓	Auto	✓	✓	35	1.8	DIN-C	
12-1950	129.95	14	✓		✓		Auto	✓					✓	30	✓	Auto	Auto	✓	✓	38	2.2	DIN-C	
12-1984	34.95	4																				Under Dash	
12-1987	359.95	16	✓	Out	✓		✓						✓	18		✓	✓	✓	✓	28	2.0	Pullout	
12-1988	179.95	13	✓		✓		Auto	✓					✓	30		Auto		✓	✓	35	2.5	Pullout	
12-1989	129.95	4			✓								✓	30			✓			33	1.4	Pullout	

Autosound EQs & boosters

Increase power and dynamic range to "punch up" bass, smooth out midrange and precisely shape the sound to your taste, speakers and vehicle interior.

Stereo Equalizers and Amplifiers

- (1) **NEW! 7-Band Equalizer.** Ideal addition to amps and equipment with line-level input/output jacks. Features slide-action controls with 12 dB range, 1/8" CD input, power on/off LED indicator and bypass button. 1 x 7 x 5 1/4". 12-1965 39.95
- (2) **7-Band EQ With Subwoofer Output.** Our finest car equalizer, with separate line-level outputs and front/rear power amps, selectable 60/100 Hz subwoofer crossover switch, front 1/8" CD jack, dual 5-LED power meter and slide action fader. Speaker/line-level input. 1 x 7 x 5 1/16". (TSP) 12-1962 89.95
- (3) **80-Watt Amplifier.** 40 watts per channel, 20-25,000 Hz. Auto power-on with LED indicator plus a switching power supply and isolated inputs to cut electrical noise pickup. Fully overload protected. 1 x 7 x 6 7/8". (TSP) 12-1957 79.95
- (4) **160-Watt Amplifier.** 80 watts per channel, 20-30,000 Hz. Input level control, auto power-on with LED, switching power supply and noise-isolated inputs. Speaker-level/line input. Fully overload protected. 1 1/2 x 8 3/4 x 7 1/2". (TSP) 12-1960 . . 139.95
- (5) **NEW! 120-Watt Subwoofer Amplifier.** Bridgeable circuit—can be used as a 60 watts per channel stereo amp or as a 120-watt mono subwoofer amp. 60 Hz/120 Hz low-pass filter. Gold-plated inputs, remote power on/off with LED indicator. 1 1/2 x 8 5/8 x 7 1/2". (TSP) 12-1964 139.95



40-Watt Booster and Equalizer/Booster

- (1) **Compact Stereo Power Booster.** Budget-priced, under-dash amplifier features power on/off button, LED "on" indicator, speaker-level input. 1 x 4 3/16 x 4 5/16". 12-1869 19.95
- (2) **5-Band EQ/Booster With CD Jack.** Small size, big performance! Features include fader control to balance 4-speaker systems and bypass button. Band centers: 60, 250, 1000, 3500, 12,000 Hz. Speaker-level input. 1 3/4 x 6 5/16 x 4 1/4". 12-1963 49.95



7-Band EQ/Boosters for Power and Performance

- (1) **NEW! 40-Watt EQ/Booster.** Front-rear speaker fader, 10-segment LED power meter, high and low-level inputs. 1 1/4 x 6 3/8 x 5". (TSP) 12-1966 59.95
- (2) **60-Watt EQ/Booster.** Features selectable 4/8-ohm speaker output, fader control, front 1/8" CD input, speaker/line-level inputs. 1 7/8 x 6 7/8 x 6 1/4". (TSP) 12-1959 79.95

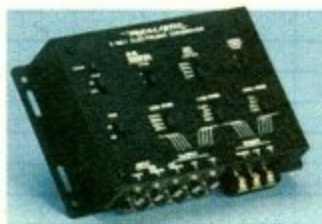
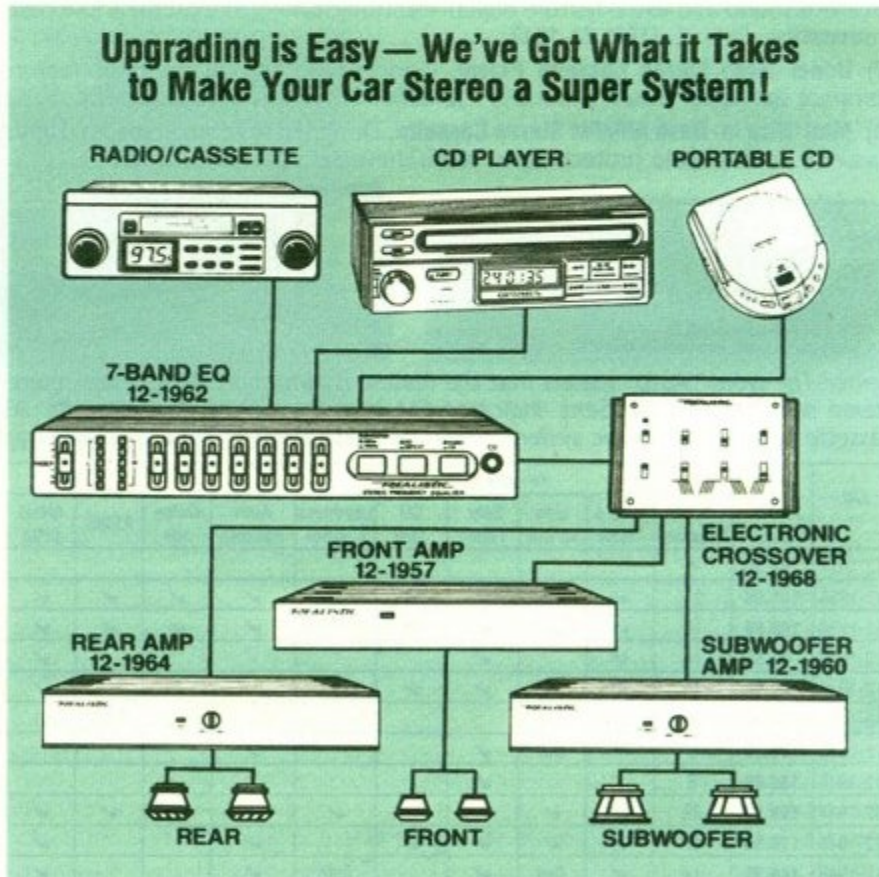

3-Way Electronic Crossover

Adds flexibility and improved speaker response. Two pairs of inputs, three pairs of outputs. Low-pass 80/120/180/250 Hz, mid-pass between 80/120/180 Hz & 2.4/3.5/5/7 kHz, high-pass 2.4/3.5/5/7 kHz. Crossover slopes: 12 dB/octave. 12VDC neg. gnd. 12-1968, 49.95

NOTE: BOOSTERS RATED TOTAL WATT'S RMS OUTPUT, BOTH CHANNELS. BOOSTERS REQUIRE 4-WIRE UNGROUNDED SPEAKER WIRING. FOR 12VDC NEGATIVE GROUND ONLY. ILLUSTRATED INSTRUCTIONS AND UNDER-DASH MOUNTING HARDWARE INCLUDED.

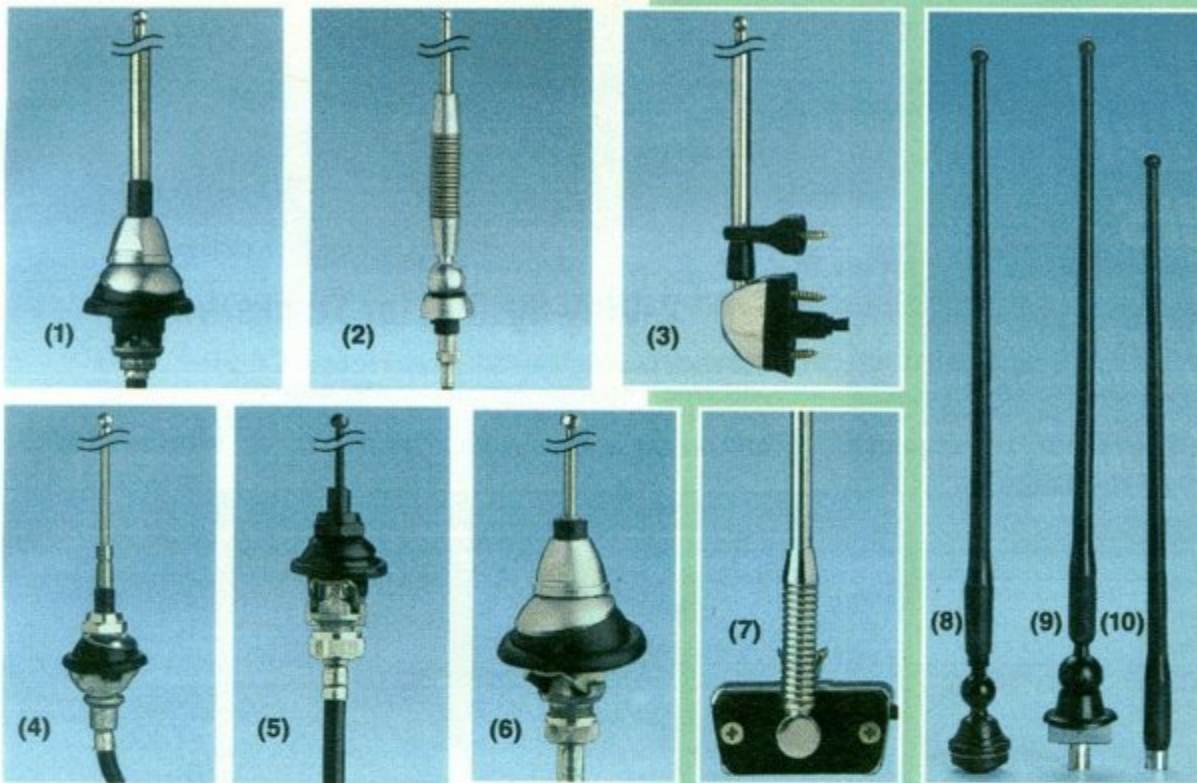

Autosound Antennas

- (1) **Universal "8-Ball"**. Top cowl/fender mount. Extends from 21 to 55", adjusts 35°. Stainless steel whip. 54" cable. **12-1306, 5.99**
- (2) **Stainless Steel Spring**. Swivel ball mount for cowl/fender. Extends from 25 to 55". Adjusts 90°. 48" cable. **12-1307 8.79**
- (3) **Pillar Mount**. Fits most Japanese cars except Honda. Extends from 19½ to 51". 61" cable. Mtg. hole spacing: 2¼ to 18". **12-1320, 8.49**
- (4) **One-Piece Mini**. For narrow fenders. 31" stainless steel whip. 54" cable. **12-1322, 6.99**
- (5) **Black One-Piece Mini**. **12-1334 7.99**
- (6) **Top Fender/Cowl Mount**. Tapered, 31" stainless steel whip. 48" cable. **12-1329 8.99**
- (7) **Gutter-Mount**. Three section whip extends to 29½". 78" cable. **12-1324 7.99**
- (8) **Rubber Ducky Antenna**. Roof/trunk/fender mount. 16" long. 50" cable. **12-1327 ... 5.99**
- (9) **Flexible Universal Antenna**. Fender or cowl mount. 15" long. 54" cable. **12-1331 ... 5.99**
- (10) **Flexible Replacement Whip**. Fits over stub of broken antenna. 14" long. **12-1333 .. 3.99**

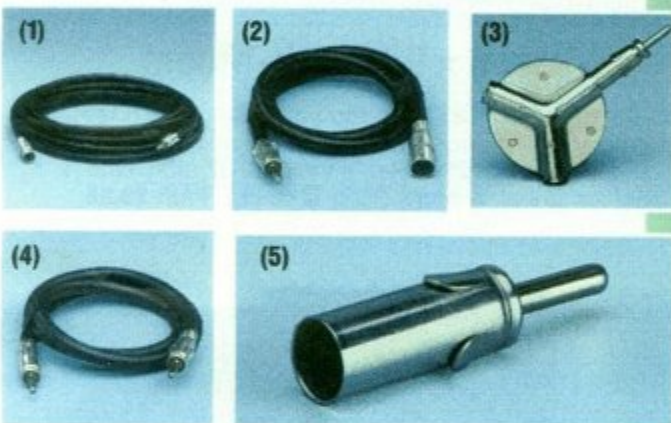

Extensions and Adapter

- (1) **12-Foot Inline Male-to-Female Extension**. Plug with jack. Built-in capacitor. **12-1311, 4.19**
- (2) **24" Male-to-Female Inline Extension**. Increases reach of cable to allow you to mount antenna anywhere on vehicle. **12-1312 ... 1.49**
- (3) **Universal 3-Way Antenna Cable Connector**. Versatile—couples two antennas to one radio or one antenna to two radios. **12-1313 1.99**
- (4) **24" Male-to-Female Extension**. **12-1314 1.49**
- (5) **GM Antenna Adapter**. Adapts GM mini connector to standard radio jack. **12-1336 ... 1.99**



Windshield AM/FM Antenna

Transparent antenna tape attaches easily to windshield—no holes to drill, no difficult hardware to install. With lead-in cable and fender cap. **12-1325 4.99**

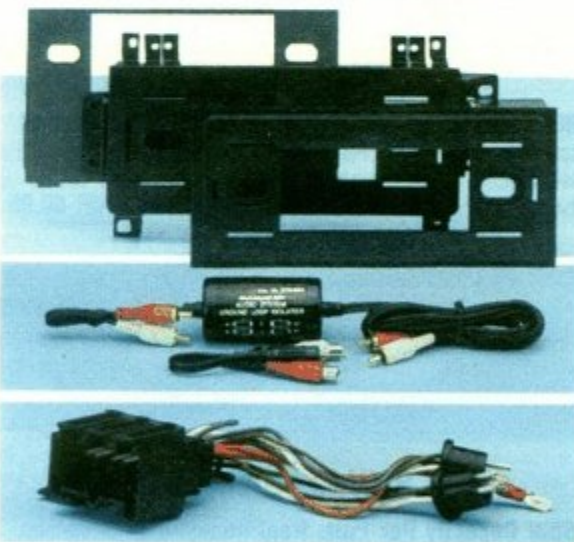

In-Dash Installation Kits

All include DIN chassis sizes and mounting hardware
GM. Fits 39 models. **12-1361 8.95**
Ford/Chrysler. Fits 69 models. **12-1362 10.95**
Toyota. (Special order from CMC.) **12-1363, 10.95**

Ground Loop Isolator

Cuts stereo system electrical noise and hum. Installs in-line between CD player and equalizer or amp input. **270-054 11.95**

Wiring Harness Adapter

For 1978-88 GM models. **270-755 9.95**
 Ask store manager about harnesses for other makes.
 Special order through our CMC system.

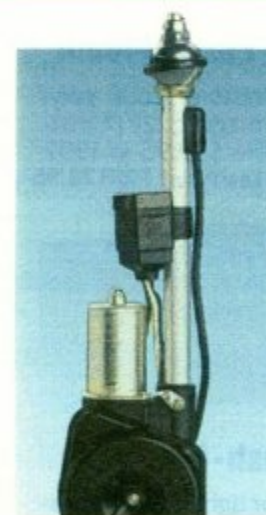

AM/FM Power Antenna

Helps prevent vandalism and breakage. Fits most cars and trucks—needs only 13" of room below mounting surface. Connects to ignition or radio and extends or retracts when either is turned on or off. Extends to 39". Stainless steel. Adapts to semi-automatic use. Includes support strap and mounting hardware. 12VDC neg. ground. **12-1330 ... 41.95**



LED Mini Car Clock

This quartz-accurate timepiece features hi/lo brightness control for easy viewing in any light. Display blanks when the ignition is off. For 12VDC negative or positive ground. **63-833 17.95**

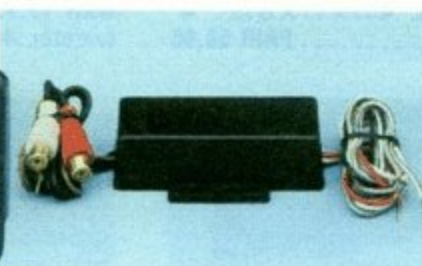

New! Line-Out Converter

Just what you need to connect amplifiers, boosters and equalizers to car stereos not equipped with line-out jacks. Available on special order (CMC). **12-1337 24.95**



FM Signal Booster

For use in "fringe" areas. Boosts FM signals by more than 10 dB to bring in more FM stations more clearly. With bracket. 1 x 2¼ x 3¾". For 12VDC neg./pos. ground. **12-1873 19.95**



CD-to-Cassette Adapter

Enjoy pure digital CD sound, with no wiring! Connects portable CD player to your current home, portable or car cassette player. It's easy—just load like a regular tape. **12-1951 19.95**

USE YOUR RADIO SHACK VALUEPLUS CARD FOR PURCHASES OF ANY AMOUNT UP TO YOUR CREDIT LIMIT

Tune up your vehicle with value-packed Realistic[®] speakers

Good speakers really make a difference, and you'll find an unbeatable selection at Radio Shack.

Choose from matched pairs and the amplified subwoofer shown below. Or, design your own super-performance system using the speakers, grilles and accessories shown on the facing page.



8" 2-Way System for Trucks/Vans

200 Watts Capacity Per Pair. Awesome bass! Carpeted, ported enclosures. Polypropylene 8" woofer with 1 1/2" voice coil and 13.3-ounce magnet. Top-firing piezo tweeter. 12 1/2" x 18 1/2" x 6 1/4", each. 4 ohms. (TSP) 12-1712 . . . PAIR 189.95



New! Amplified Subwoofer System

100 Watts Maximum Output. Adds thunderous bass to any car stereo. Has 8" woofer with dual voice coil, bass-level control, 120/250 Hz selector, on/off switch, prewired leads, easy hookup. 9 x 17 1/2 x 8 3/4". 4 ohms. (TSP) 12-1718, Each 99.95



New! 3-Way 6 x 9" Flush-Mount

200 Watts Capacity Per Pair. Flush mount design is ideal for rear deck, many door panels. Moistureproof polypropylene woofer, 20-oz. magnet. 2" mylar midrange. 1" polyamide tweeter. Molded grilles. 4 ohms (TSP) 12-1719 . . PAIR 99.95



Deluxe 6 x 9" 3-Way Flush-Mount

120W Capacity Per Pair. Moisture-proof polypropylene woofer with 16-oz. magnet, 2 1/2" midrange, 1 1/2" piezo tweeter. Were \$99.95 in 1992 Catalog. (TSP) 12-1859 . . New Low Price! PAIR 79.95



4-Way! Our Finest Surface-Mount

100W Capacity Per Pair. Superb performance and looks. Each has 4" woofer with 8-oz. barium magnet, 2" midrange, dual 1" tweeters. Metal grilles. 5 1/16 x 11 7/16 x 6 11/16". (TSP) 12-1713 . . PAIR 79.95



5 1/4" 3-Way Plate-Design

80W Capacity Per Pair. Plate design fits 4 1/2" round to a 6 x 9" hole. Needs only 1 1/2" depth. 5 1/4" woofer, 6 1/4-oz. magnet, 2 1/2" midrange, 1 9/16" tweeter. 2 3/4 x 9 3/4 x 6 3/4". (TSP) 12-1711, PAIR 69.95



6 x 9" 2-Way Flush-Mount

80W Capacity Per Pair. Ideal for tight spaces. Moistureproof polypropylene woofer with 10-oz. magnet, 2 1/2" tweeter. Were \$69.95 in 1992 Catalog. (TSP) 12-1715 New Low Price! PAIR 59.95



4 1/4" 3-Way Surface-Mount

80W Capacity Per Pair. Each has 4 1/4" woofer with 8-oz. barium magnet, 2 1/2" midrange, 1" tweeter. Metal screen grille. Approx. 4 1/2 x 11 x 6 1/2". 4 ohms. (TSP) 12-1716 PAIR 59.95



5 1/4" 3-Way Flush-Mount

60W Capacity Per Pair. Real heavyweights deliver amazing performance! Each has a 5 1/4" woofer with 17.72-oz. magnet, 2" midrange and a 1" tweeter. 4 ohms. 12-1717 PAIR 49.95



Compact 2-Way Surface-Mount

30W Capacity Per Pair. Great sound; low-profile design ideal for rear deck. 3" woofer, 3.6-oz. magnet, 2" tweeter. 3 7/8 x 5 1/8 x 6 1/4". Were \$42.95 in 1992 Catalog. 12-1707, New Low Price! PAIR 39.95

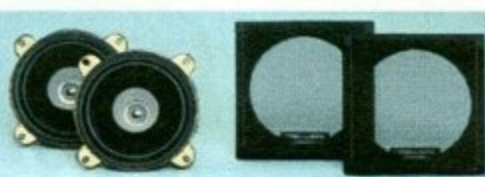

Full-Range 4" Flush-Mount

40W Capacity Per Pair. Only 1 1/2" deep, they fit where space is tight. Each has a moistureproof polypropylene dual-cone driver with 4.8-oz. magnet. Open-mesh grilles. 12-1704 PAIR 29.95



Economical 5 1/4" Flush-Mount

20W Capacity Per Pair. For limited space. Less than 2" depth needed for mounting. Wide-range driver, 2.9-oz. magnet. Molded grilles. Were \$22.95 in 1992 Catalog. 12-1714, New Low Price! PAIR 19.95



Upgrade to a Piezo Tweeter

■ No crossover required ■ 75-watt capacity
 (1) 2", 5-25 kHz response. 40-1383, Each 4.95
 (2) 3 1/4", 4 kHz-25 kHz. 40-1397 ... Each 9.95



6x9" Enclosure Pair

Deluxe, extra-sturdy wood boxes covered in carpet. Use 'em at home, too. Spring terminals for fast hookup. 8 1/4 x 12 3/4 x 7 1/2". 40-171 .. PAIR 34.95



America's Favorite Speaker

Minimus®-7.40W. 4" woofer, 1" tweeter. 7 1/16" tall. Black, 40-2030. White, 40-2045, Each 49.95
 Black Mounting Brackets. 40-2031 PAIR 17.95
 White Mtg. Brackets. (CMC). 40-2060 PAIR 17.95



Dynamic Horn Tweeter

Improve your system's high-frequency response with this wide-dispersion, 2 1/2" tweeter. 6 kHz to 16 kHz. 50W capacity. 40-1278 Each 13.95



Polypropylene-Cone Woofers

Size	Power Capacity	Magnet Wt.	Cat. No.	Each
8"	35 Watts	10 oz.	40-1024	33.95
10"	50 Watts	12 oz.	40-1014	37.95
12"	50 Watts	19 oz.	40-1026	53.95



100 watts capacity

2-Way Speaker Crossover

Sends lows to woofer and highs to tweeter. Sealed polyurethane enclosure. Crossover: 3000 Hz. 12 dB/octave. 3 7/16 x 5 7/16 x 1 15/16". 40-1305 .. 17.95



Soft-Dome Dynamic Midrange

Smooth 1.5 kHz to 10 kHz response adds convincing realism. 4". 70 watts capacity. 10.8-oz. magnet. 40-1281 Each 23.95



Dual-Voice-Coil Subwoofers

Size	Power Capacity	Magnet Wt.	Cat. No.	Each
8"	100 Watts Total	18 oz.	40-1348	41.95
12"	120 Watts Total	19 oz.	40-1350	61.95



New! Speaker Crossover Coil

Use this high-linearity coil to make your own custom crossover. 200 watts capacity. Cutoff: 150 Hz at 4 ohms, 300 Hz at 8 ohms. 40-1326 .. 13.95



3 1/2" Round Speakers

Capacity in Watts	Magnet Weight	Cat. No.	Each
20	5.0 oz.	40-1325	8.95
4	2.8 oz.	40-1333	4.95



4x6" Oval Speaker

Popular size with wide-range sound and 5.3-oz. ceramic magnet. 10 watts capacity. Replace your worn out speakers. 40-1298 Each 7.95



4" Round Speakers

Capacity in Watts	Magnet Weight	Cat. No.	Each
10	6.8 oz.	40-1197	10.95
2	0.53 oz.	40-1208	5.95



5x7" Oval Speaker

Fits many Chrysler and Toyota rear decks. Selectable 4/8/16 ohms. 10 watts capacity. 40-1261 Each 11.95



5" Round Speakers

Capacity in Watts	Magnet Weight	Cat. No.	Each
20	9.8 oz.	40-1284	10.95
10	5.3 oz.	40-1909	8.95
5	2.8 oz.	40-1240	6.95



4x10" Oval Speakers

Capacity in Watts	Magnet Weight	Cat. No.	Each
30	10.0 oz.	40-1297	15.95
10	5.3 oz.	40-1243	13.95

Speaker Grilles

Deluxe Wire-Mesh Grilles

Shown above. Protect speakers and add a classy custom appearance to any vehicle. Include mounting hardware.

For Speaker Size/Style	Cat. No.	Each
5 1/4" Round	40-1336	4.99
6 x 9"	40-1335	6.99

Rugged All-Steel Grilles

For Speaker Size/Style	Cat. No.	Each
6 x 9"	40-1175	3.69
8" Round	40-1345	7.95
10" Round	40-1357	8.95
12" Round	40-1346	10.95
15" Round	40-1358	16.95



5 1/4" Round Speakers

Capacity in Watts	Magnet Weight	Cat. No.	Each
40	10.0 oz.	40-1354	13.95
8	3.3 oz.	40-1241	6.95



6x9" Oval Speaker

Capacity in Watts	Magnet Weight	Cat. No.	Each
30	10 oz.	40-1265	16.95
6	3 oz.	40-1269	11.95



3-Way 6x9" Speaker

Super value! 30 watts capacity, 3" midrange, 1/2" tweeter, 10-oz. magnet. 40-1356 Each 27.95

Low-Cost Molded Grilles

(1) Door Mount For 4" or 5" speakers. 40-1321 Each 3.29
 (2) Rear Deck. For 6 x 9" speakers. 40-1322 Each 5.95



Speaker Fader Control

Balances front and rear speakers to suit taste. Easy to install under dash. Handles up to 50 watts total output. 270-048 8.99



Selector Switch

Lets you switch speakers between a separate stereo tape player and radio. With mounting hardware. 270-045, 4.99

FADER AND SELECTOR HAVE COLOR-CODED LEADS, ARE 8 OHMS IMPEDANCE AND INCLUDE HOOKUP INSTRUCTIONS



New! Compact Tri-Band Detector

GaAs diode front-end gives you long-range warning of X, K and Ka-band "photo" radars. Has separate LEDs and tones for each band. Tone's pulse-rate and LED meter indicate distance. Selectable tone/LED or tone-only alert. Mute button cuts tone volume and resets for next encounter. City/highway control and FAST circuit cut false alerts. (TSP) 22-1637, 159.95



Tri-Band Detector, New Low Price!

GaAs diode front-end for long range on X, K and new Ka "photo" radar. Large main LED plus separate LEDs and tones for X, K and Ka. Tone/LED/both modes. Tone's pulse-rate and 5-LED meter indicate relative distance. City/highway control and our FAST processor cut annoying false alarms. Was \$149.95 in Flyer #487. (TSP) 22-1629 . . . **New Low Price! 119.95**

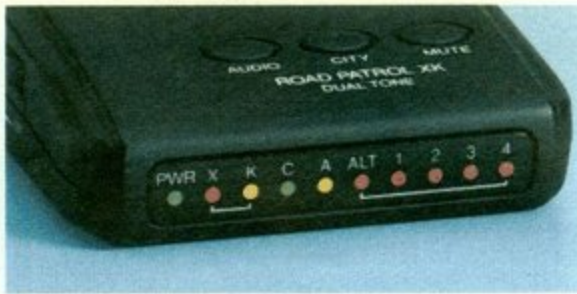

New! Pocket-Size Dual-Band Detector

Excellent, money-saving choice if you drive in areas where Ka-band radar is not used. Separate LED indicators and different tones for X and K-band. Tone pulse rate and 4-LED meter indicate relative distance. Has selectable tone/LED or tone-only modes and convenient mute/auto-reset. City/highway sensitivity switch and FAST reduce falsing. (TSP) 22-1638, 89.95

A Road Patrol XK[®] can help you be a better driver

It's easy for any driver to unknowingly exceed the speed limit, especially on an open highway. All Road Patrol-brand radar detectors provide long-range alerts to traffic radar. By increasing awareness of enforced limits, one of these ultracompact radar detectors can actually help a driver remain at safer, legal speeds.



Available Sept. 30, 1992

Our Best Ever! New Tri-Band Detector With UltraWideband Ka Coverage

Designed to detect the full range of Ka-band frequencies used by the new wideband traffic radar guns and "photo" radar. Sensitive GaAs (gallium arsenide) diode front-end gives you maximum range on all radars—X, K and Ka.

Separate LEDs and different tones for X, K and Ka. Dark mode button for discreet night driving. Tone-mute button. FAST circuit cuts false alerts and spurious signal output while extending range. (TSP) 22-1639 . . . **199.95**



New! Compact Dual-Band Detector

Small in size, it's a giant in performance! This detector features different tones to alert you to X and K-band traffic radars. A 5-LED signal-strength meter and the tone's pulse rate help you judge relative distances to radar. You also get a city/highway sensitivity switch and Radio Shack's exclusive FAST signal processor to help reduce false alerts. Rotary on/off/alert volume control. (TSP) 22-1628 . . . **79.95**



Radar Detector Accessories

- (1) **NEW! Radar Detector Bracket.** 270-038 **14.95**
- (2) **NEW! Universal Clip.** Stainless steel. Visor-mount radar detector or glasses case. Use as belt clip. 270-033 . . . **3.49**
- (3) **Suction-Cup Mount.** For windshield mtg. 270-034, **7.99**
- (4) **Adjustable Bracket.** Easy way to mount, precisely position and remove most radar detectors. 270-037 **9.95**
- (5) **Y-Adapter.** Power two 12VDC devices. 270-1535, **5.99**
- (6) **Universal Coiled Power Cord.** Four plug adapters. Fits most detectors, 12VDC TVs. 2-amp fuse. 270-1528, **9.95**

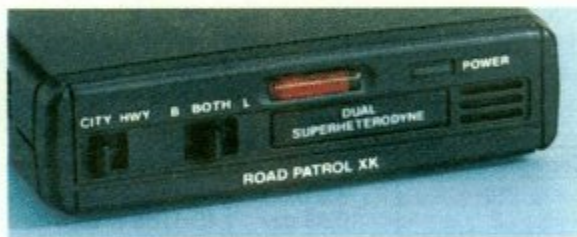

Dual-Band Detector, New Low Price

A better value than ever! Even our lowest priced detector gives you a discreet size and the long-range performance of a GaAs diode front-end and a superhetrodyne circuit. You also get tone/LED/both selectability, city/highway and hi/lo/off switches and our exclusive FAST signal processor system to minimize annoying false alerts. Was \$79.95 in 1992 Catalog. (TSP) 22-1623 **New Low Price! 59.95**

READY TO USE IN SECONDS! Every Road Patrol radar detector comes with a fuse-protected power cable that plugs into your vehicle's lighter socket. We include a clip-on sun visor bracket plus a set of hook and loop fasteners for dash-mounting. Either mounting method lets you quickly remove your detector for safekeeping.

FAST[®] SYSTEM. All Road Patrol radar detectors feature False Alert Suppression Technology. This unique signal processor circuit prevents false alarms caused by signals from other radar detectors but does not reduce sensitivity to authentic traffic radar signals.

Cat. No.	22-1623	22-1628	22-1638	22-1629	22-1637	22-1639
Price	59.95	79.95	89.95	119.95	159.95	199.95
Size	3/4 x 2 3/4 x 4 1/8"	3/4 x 2 3/4 x 4 1/8"	1/2 x 2 3/8 x 4 1/2"	3/4 x 3 1/8 x 4 1/4"	1 1/16 x 2 1/4 x 3 11/16"	1 1/8 x 2 7/8 x 4 2/16"
Dual-Band	✓	✓	✓			
Tri-Band				✓	✓	
Tri-Band Wide						✓
Visual Indicators			X, K	X, K, Ka	X, K, Ka	X, K, Ka
Separate Tones		X, K	X, K	X, K, Ka	X, K, Ka	X, K, Ka
City/Highway Switch	✓	✓	✓	✓	✓	✓
Mute			✓		✓	✓
Meter LEDs		5	4	5	4	5
Sensitivity*	X: -114; K: 104	X: -114; K: -104	X: -114; K: -104	X: -114; K: -114; KA: -103	X: -114; K: -104; KA: -100	X: -112; K: -102; KA: -95

*Sensitivity measurement in dBm/cm²



Alarm With Pocket Pager and Remote*

Automatically disables engine starter when armed—provides maximum 24-hour protection! Keychain remote arms and disarms system and has "panic" button to sound the alarm in an emergency. When triggered, system transmits signal to pocket pager up to two miles away and/or sounds loud electronic siren. Instant and delayed alarms. Selectable security code—prevents false pages and arming/disarming from other systems. Pager requires 9V battery. **49-796 159.95**
Extra Keychain Remote. (CMC) 49-901, 14.95. Extra Pager. (CMC) 49-920, 31.95



Keychain Remote and Starter Disable*

A great basic alarm system for your vehicle! Keychain remote easily fits in pocket or purse and allows you to arm/disarm system from up to 20 feet away. Starter disable with remote override prevents the engine from being started while the system is armed. Valet override temporarily disengages the system and provides access to your vehicle for parking attendants and mechanics. Includes dash-mount status lights and mounting hardware. **49-850 89.95**
Extra Keychain Remote. (CMC) 49-902 19.95



Our Best! With Pager and Remote Locator/Panic Button*

Our finest alarm system is loaded with most-wanted features! Sounds siren and/or signals pager up to 2 miles away. Automatic starter disable. Includes 2 keychain remotes with arm/disarm and "panic" button to activate siren and car horn in an emergency. Car locator "chirps" siren and/or flashes lights. Selectable security code. Each pager requires 9V battery. **49-875 199.95**
Extra Keychain Remote. (CMC) 49-903 . . 21.95 Extra Pager. (CMC) 49-921 . . 39.95

**Every 22 seconds
 A car is stolen...
 is yours next?**

Why take unnecessary chances with your investment? It's simple and inexpensive to add a Mobile Alert® vehicle alarm to your car. Come to Radio Shack today and let us help you find the right alarm for your vehicle. Mobile Alert alarms can help keep your car from becoming just another statistic.

** May qualify for auto insurance discount. Call your agent.*

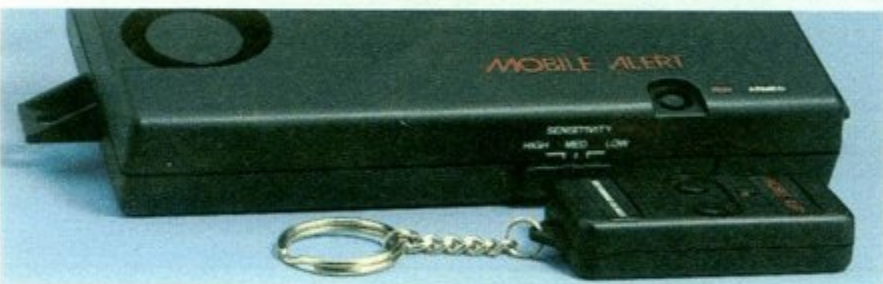

Infrasonic Alarm With Keychain Remote

Reliable, state-of-the-art security. Senses sudden, subaudible changes in air pressure, such as a car door or trunk opening. Keychain remote control arms/disarms system from up to 20 feet away. Sounds high-power built-in siren, or add #49-488, below. High/medium/low sensitivity switch. Programmable security code prevents system from being turned on or off by another system on the same frequency. Exit delay gives you time to get out of car before alarm arms. External siren output terminals. Easy 2-wire hook-up—system is ready to run in just minutes. **49-825 49.95**

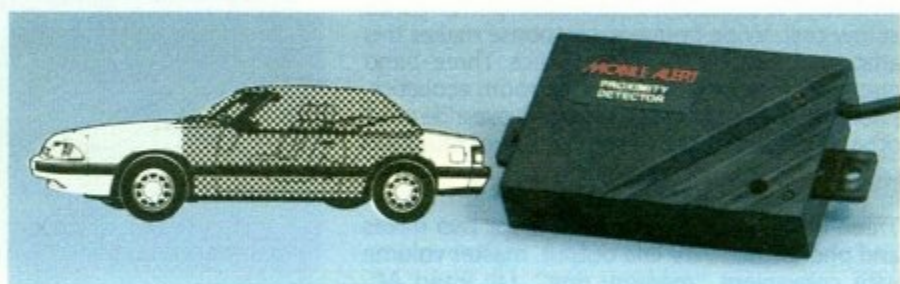

New! Proximity Intrusion Sensor

Now it's safe to leave your top down! The sensor creates an invisible electronic "bubble" that protects your vehicle even with the top down or windows open. The moment any part of an intruder passes through the electronic field, the sensor activates your alarm. High-frequency shield actually penetrates plastic, glass and wood for out-of-sight mounting under rear seat or console. Ignores wind, temperature changes and sunlight. Add state-of-the-art technology to your existing system, or use with any of the systems on this page. Works well with cars, boats, trucks and camper shells. **49-640 39.95**

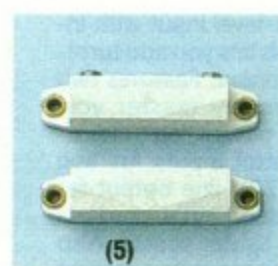

Siren and Motion Sensor

- (1) **Extra-Loud 2-Sound Siren.** Requires 12VDC at 500 mA. **49-488 19.95**
- (2) **Electronic Shock/Motion Sensor.** Quick response, extremely low current drain. **49-630, 12.95**

Alarm Pin Switches

- (3) **Short Pin Switches.** For limited space. Solderless lug terminals. **49-508 Pkg. of 2/2.99**
- (4) **Long-Throw Pin Switches.** Crimp-style connector. Customize your alarm system. **49-509, Pkg. of 2/2.89**

Switches and Decals for Door or Window

- (5) **Door/Window Switch.** Ideal for sliding truck windows. **49-512 5.19**
- (6) **Window Decals.** Function as a low-cost deterrent. **49-507 Pkg. of 4/1.19**

Make Radio Shack your #1 choice in PA equipment

We've got it all—amplifiers, speakers, mixers, mikes and stands, cables and connectors—everything you need for a custom public address system. And, our knowledgeable sales staff can help you select a system that meets your particular needs.



(1)



(2)



(3)

(1) Realistic® MPA-95 100-Watt Amplifier With Built-In Mixer and Antifeedback Control. Our best has the power and performance demanded in auditoriums, churches and dance clubs. Features four high-impedance mike inputs with 1/4" phone jacks and four low-impedance inputs with professional-type XLR 3-pin jacks. Has aux input for adding mixer or tape deck. Variable feedback filter cuts any selected frequency from 300 to 3000 Hz, by 12 dB, to eliminate feedback. Convenient rotary knobs for precise control of each channel. 70V line output, lighted power meter and LED clipping indicator. Fully overload protected. UL listed AC. (TSP) 32-2036 219.95

SPECIFICATIONS. Frequency Response: 60-20,000 Hz \pm 3 dB. Power: 100 watts rms at 4 ohms. Outputs: Mix bus, EQ in/out, push-terminals, 70V line and phono-type jacks for 4 to 16-ohm speakers, 1/4" headphone jack. Power Requirement: 120VAC, 60 Hz, 200W. Size: 4 x 14 1/2 x 10 1/2".

(2) NEW! Realistic MPA-45 35-Watt Amplifier With Built-In Equalizer. Dependable performance at low cost. Wide frequency response makes this amp ideal for music as well as voice. Three-band graphic EQ for tailoring sound to room acoustics. Priority terminals permit Channel-1 override of all other channels—handy for talking over music for paging or emergencies. Built-in mixer, plus built-in preamp for magnetic-cartridge turntable. Three rotary knobs control inputs for two mikes and phono/aux. 70V line output, master volume with convenient "memory ring". UL listed AC. (TSP) 32-2035 99.95

SPECIFICATIONS. Frequency Response: 70-20,000 Hz \pm 3 dB. Power: 35 watts rms at 8 ohms. Outputs: 4, 8, 16 ohms; 70V line; terminals for adding optional SPST switch for remote priority switching. Power Requirement: 120VAC, 60 Hz, 200W. Size: 3 1/2 x 11 1/4 x 7 1/2".

(3) NEW! Realistic MPA-30 20-Watt Dual-Power Amplifier. Operates on AC or 12VDC—excellent for indoor or mobile use. Accepts either low or high-impedance mikes. High-level input with individual channel fader controls lets you add turntable or other auxiliary component. Features two front-panel mike inputs, rotary master volume/tone controls and LED power "on" indicator. Three rotary knobs control inputs for two mikes and phono/aux. Has 70V line output for multi-speaker systems. Included 12VDC cord lets you plug amp into cigarette lighter socket. Also includes AC cord and a handy mounting bracket for mobile use. Ventilated metal case. UL listed AC. (TSP) 32-2034 79.95

SPECIFICATIONS. Frequency Response: 150-20,000 Hz \pm 3 dB. Power: 20 watts rms at 8 ohms. Outputs: 4, 8, 16 ohms; 70V line. Power Requirement: 120VAC, 60 Hz, 40W or 12VDC neg. ground. Size: 3 5/8 x 11 1/2 x 9".

A guide to designing a public address system

Each PA sound system installation is unique. The best installation for your purposes can only be found through trial and error. However, the following steps will help you get started designing your sound system.

Speaker Locations. Speakers usually should be placed at the front of the room facing the audience. Longer, narrower rooms will need more speakers. These should be placed along the side walls, angled towards the back/center of the audience area. Keep all speakers facing the same end of the room and never facing the microphones. Use 70-volt line transformers with systems having over 200 feet of speaker cable.

Power Requirements. Calculate the area of your listening room and the length-to-width ratio. Check the table at right to find the number/size of speakers and the amplifier power needed. "Room A" refers to rooms with a length-to-width ratio of 1.5 to 1. "Room B" ratio is between 1.5 and 3 to 1.

Room Area In Square Feet	Amplifier Power	Room A Speakers	Room B Speakers
Less than 10,000	20 watt	2 - 8"	4 - 8"
10,000 to 50,000	35 watt	2 - 12"	4 - 12"
Over 50,000	100 watt	4 - 12"	6 - 12"

Noise levels and room acoustics play a part when determining the amount of power needed. If you are unsure, buy the next higher-power amplifier. You can never have "too much" power.

Microphones. Use omnidirectional mikes for small conferences and cardioid mikes if acoustics (crowd noises, moving stage props) are a problem.

Amplifier. Select an amp with ample power to drive the speakers you have selected (from table). Be sure the amplifier has the correct type of mike inputs (low or high impedance) and inputs for any accessories you want to add (mixer, CD player).

And, as always, courteous assistance is as close as your nearby Radio Shack store.



(1)



(4)



(2)



(5)



(3)



(6)

Say it loud & clear with a complete Realistic PA system

Whether you need a PA system for your company picnic, small business or meeting hall, Radio Shack has one that's right for you. And we have all the accessories to make installation easy.

F.Y.I.

70-VOLT LINE TRANSFORMERS. Used in multiple-speaker systems, these let you drive different speakers at different volume levels. They help lower line losses and permit easier exact speaker matching.

DESK vs FLOOR MIKES. All our microphones have a standard 5/8" thread and can be used on either desktop stand or floor stand.

WIRELESS MIKES. Permit speakers and singers to move freely around the stage without a trailing cord.

(1) Indoor/Outdoor System . . 147⁸⁰

- Realistic MPA-30 20-watt AC/mobile amplifier
 - Highball-2 dynamic mike ■ Two 5" speakers
- 32-2034/33-985/40-1236

(2) Office/Restaurant 225²⁵

- Realistic MPA-45 35-watt amp with built-in EQ
 - Tight-cardioid microphone ■ Desk stand
 - Four 10W, 70-volt line transformers
 - Four 8" speakers with ceiling grilles
- 32-2035/33-992/33-370/32-1031/40-1272/40-1223

(3) "Anywhere" System 251⁶⁰

- Realistic MPA-30 20-watt AC/mobile amplifier
 - Super-omnidirectional mike with deluxe stand
 - PA-96 portable column speaker system
- 32-2034/33-1070/33-325/40-1413

(4) Auditorium System 415⁶⁵

- Realistic MPA-45 35-watt amp with built-in EQ
 - Two tight-cardioid mikes with cast-base stands
 - Two PA-96 column speaker systems
- 32-2035/33-1073/33-320/40-1413

(5) Stage Performance 647⁷⁰

- Realistic MPA-95 100-watt amplifier
 - Unidirectional dynamic microphone with stand
 - FM wireless mike ■ Two PA-96 column speakers
- 32-2036/33-1073/33-320/32-1228/40-1413

(6) Versatile Club System . . . 813⁶⁰

- Realistic MPA-95 100-watt amplifier
 - Two Highball microphones with mike stands
 - One wireless mike ■ Two PA-100 speakers
- 32-2036/33-984/33-320/32-1224/40-1412

Announcing: sound buys to address your needs, by Realistic



Monitor-Style Speaker

Realistic® PA-100. Ideal both for auditoriums and outdoors, suitable for voice and music amplification. The big 15" woofer and piezo horn tweeter team up to deliver powerful sound with deep bass and crisp, clear highs. Extended frequency response of 60-25,000 Hz. Handles 100 watts. Impedance, 8 ohms. Sensitivity: Rated 92 dB (SPL at 1W/1M). The rugged vinyl-coated enclosure, protective metal corners and carrying handle make it perfect for portable operations. Spring terminals and 1/4" jack make hookup easy. 23³/₄ × 18³/₄ × 11".

40-1412 159.95

Column-Style Speaker

Realistic PA-96. Designed for uniform sound dispersion with excellent sound quality. Excellent for schools, conference rooms, demonstration areas and other locations that require controlled sound coverage. Dual 8" woofers and a piezo horn tweeter make it suitable for both voice and music. The 1/4" phone-jack and two spring terminals make connection to almost any amplifier simple. Handles 80 watts. Impedance, 8 ohms. Frequency response, 100-25,000 Hz. Rated 92 dB (SPL at 1M/1M). Vinyl enclosure, metal-covered corners, and carrying handle. 30 × 10 × 6⁷/₈".

40-1413 119.95

Wall-Mount Speaker. For PA paging or background music. Has 8" speaker, volume control. Impedance, 8 ohms. Walnut vinyl finish. 10³/₄ × 10³/₄ × 4³/₄".

40-219 ... 21.95



Round Ceiling Grilles. Use for mounting 4" and 8" speakers. Steel with white enamel finish. Includes mounting hardware.

4" Grille.
40-1220 .. 4.59
8" Grille.
40-1223 .. 5.69



Full-Range Speakers. For 4" and 8" ceiling grilles. 8 ohms.

4" 10 Watts.
40-1197 10.95
4" 2 Watts.
40-1208 6.95
8" 30 Watts.
40-1286 ... 18.95
8" 10 Watts.
40-1272 ... 10.95



70-Volt Line Transformer. For multi-speaker systems. Permits driving speakers at various power levels from a 70-volt line—does not affect other speakers in system. For 4, 8, 16 ohms.

32-1031 5.95



Available
Sept. 30, 1992

All-Weather Speaker

NEW! This moisture-resistant 6" 2-way speaker is made specifically for use in humid conditions and areas where water spray may occur, such as boat, trailer, patio and pool-side. Has 20-watt power capacity, 8 ohms impedance. Gasket and mounting screws included. 40-1371 24.95

Outdoor 360° Speaker

NEW! Perfect for use around deck, patio or poolside. Moisture-resistant omnidirectional design delivers rich sound in full 360° pattern. Adjustable bracket allows mounting under eave on soffit or wall. Handles 30 watts. Impedance, 8 ohms. With mounting bracket and hardware. 40-1352 49.95

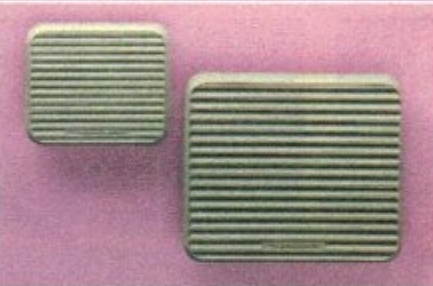

Indoor/Outdoor Speakers

4" Speaker. Moisture resistant, with mounting hardware. Handles five watts. Impedance, 8 ohms. 4³/₄ × 5¹/₂ × 3".

40-1227 13.95

6 1/2" Speaker. Moisture resistant, with mounting hardware. Handles 15 watts. Impedance, 8 ohms. 4¹/₂ × 8¹/₄ × 3⁷/₈".

40-1248 23.95



Budget Powerhorn® Speakers

8". It's shockproof and water resistant—ideal for use indoors or out. 15 watts capacity. 8 ohms. Mounting bracket included. 40-1239 33.95

5". Tough enough for outdoor use. Same rugged features as above but handles 8 watts of power. 8 ohms. With mounting bracket. 40-1236 21.95



4" Indoor/Outdoor Powerhorn

A truly outstanding performer in a compact size. Put the sound where you need it. The rugged shockproof and water resistant design helps ensure years of trouble-free use indoors or out. Comes with mounting bracket for easy installation on any flat surface. Power output: 5 watts. Impedance, 8 ohms.

40-1235 14.95



Outdoor Super Powerhorn

High-efficiency design delivers maximum voice and music output where you need it. Handles 40 watts of power. Metal swivel base lets you aim the sound. Impedance, 8 ohms. SPL:110 dB (1W at 1M). Mounting hardware. 11 × 6¹/₂ × 8¹/₂".

40-1307 41.95

Just a few things a Realistic® stereo mixer can do for you

Schools, churches, businesses, audio recording buffs and videomakers—have you considered the benefits a mixer brings to your audio/video or PA system? With a mixer you can balance the volume level of several audio sources at once and send the resulting "mix" to an amplifier for live sound, or to a tape deck, camcorder or VCR for recording.

A mixer is perfect for combining music and voice in a PA system—ideal for school musicals and church anthems with recorded accompaniments, and indispensable for DJ use. It's recommended when participants in conferences and school board or city council meetings use individual mikes. A mixer helps properly balance sound when amplifying or recording music groups. It adds inputs to your stereo receiver. It can even help you add pro-quality background music and narration to home videos. When you consider all the uses and our low prices, you'll wonder how you got along without one!



Five-Channel Stereo Mixer

Mix live and recorded sources—up to three mikes plus two turntables or two tape decks. Three "pan pot" controls let you adjust each mike's apparent position in the stereo image. You also get Glide-Path® channel faders and master volume control, cross fader between stereo channels, and dual lighted VU meters for easy signal monitoring. Mono/stereo switch permits monaural signal to both output channels. Cue/monitor for use with stereo headphones, 1/4" headphone jack with adjustable level. 20-20,000 Hz response. 2 3/4" x 10 3/4" x 8 1/2". UL listed AC. (TSP) **32-1200** **119.95**

Five Channels, AC/DC

Perfect for mobile applications—operates on battery power when AC isn't handy. You can mix up to five audio sources at a time—two mikes, two turntables and one tape deck. Glide-Path controls for each channel make fades smooth and easy, and dual VU meters allow precise signal monitoring. "Listen in" with the cue monitor. Mono/stereo output switch, tape outputs and line outputs, headphone monitor jack, 1/4" mike jacks. Battery-test button. Response 20-20,000 Hz. 2 3/4" x 10 1/2" x 7 1/2". Requires 4 "AA" batteries or AC adapter. (TSP) **32-1101** **79.95**
AC Adapter. UL listed. **273-1454** **7.95**



Sound Level Meter

Monitor music or noise levels in home, auditorium or industry. Use with a frequency equalizer to set audio response of stereo or PA systems for optimum sound in any room. Reads to 126 dB SPL with slow or fast response for checking peak and average noise levels. Seven ranges. "A" or "C" weighting. Electret mike. Recording output. 6 1/4" x 2 7/16" x 1 3/4". Requires 9V battery. **33-2050** **31.95**

One-Watt Speaker/Amp

NEW! This one-piece system sets up anywhere for amplified sound wherever you need it. Plug in a microphone for public address, or use as a musical instrument amplifier. Variable tone and volume controls for customizing the sound. Features an aux input and 1/8" mike jack. 5 x 4 x 2 3/4". Requires 4 "C" batteries. **32-2040** **19.95**

AC Adapter. UL listed.

273-1454 **7.95**



PA Musical Powerhorn

This portable PA system is ideal for ballgames or anywhere you want to be heard. Plays 94 built-in tunes—everything from major college fight songs to nostalgic favorites, plus up to five more that you can program yourself. Use the built-in microphone to be heard up to 300 feet away. Can also be used as an organ. Includes a song list. Adjustable shoulder strap for easy carrying, power-on indicator, keypad to select or program tunes. Requires 8 "AA" batteries. **32-2030** **39.95**



Electronic Reverb Control

Great for DJs or music groups! Adds echo and reverb enhancement to recordings, "live" vocals or amplified musical instruments. Has input jacks for cassette deck plus microphone or guitar. Adjustable 5-95 mS delay. Glide-Path controls for reverb depth, delay, repeat and mike. With jacks for line-in, line-out and 1/4" mike in/out. Monaural circuit. 2 1/2" x 6 3/4" x 4 3/4". Requires 6 "AA" batteries. **32-1110**, **44.95**

Stereo Mike/Line Mixer

Perfect for adding inputs to expand your PA system. Also ideal for recordings from multiple sources—mixes up to four mikes or line inputs simultaneously. Features left/right Glide-Path faders on all four channels. Stereo/mono switch provides custom sound selection. Battery-test LED indicator, microphone level output. Ruggedly constructed for home or pro use. 2 3/4" x 8 3/4" x 5". Requires 9V battery. **32-1105** **34.95**

Dynamic microphones for stage, recording and PA systems



(1) Pro-Unidirectional Highball. An outstanding mike for public speaking, recording, musicians, and vocal use without picking up annoying background noise. Has on/off control switch. XLR adaptable. 80 to 15,000 Hz response. Includes removable 16-ft. cable with 1/4" plug, case, stand adapter. (TSP) **33-984** **59.95**

(2) Super-Omnidirectional. A great utility microphone that delivers a wide 40-17,000 Hz response. Rugged body with rubber shock ring to reduce vibration noise. Low-impedance (XLR) adaptable. Includes removable 16-ft. cable with 1/4" plug, storage case and stand adapter. **33-1070** **47.95**

(3) Unidirectional Dynamic. Die-cast zinc body. 50-15,000 Hz response. On/off switch. Comes with a 5-ft. cable, 1/4" plug and stand adapter. **33-1073** **35.95**

(4) Super-Unidirectional. Tight-cardioid pattern solves feedback/background noise problems. Has 80-12,000 Hz response. 600 ohms. On/off remote switch control. Includes 6-foot cable, 1/4" plug and mike stand adapter. **33-992** .. **27.95**

(5) Omnidirectional Highball-2. Built-in filter eliminates breath "pops". Ideal for vocalists and public speakers. Has 50-13,000 Hz response. 600 ohms. Remote on/off switch. With 6-foot cable, 1/4" plug and stand adapter. **33-985** **23.95**

(6) Unidirectional Highball-7. This lightweight microphone is ideal for speeches and use on public address systems. Built-in filter and wire mesh screen cut feedback and reduce wind and breath noise. Response is 80-15,000 Hz. 600 ohms. On/off control switch. 10-ft. cable, 1/4" plug and stand adapter. **33-986** **17.95**



Amplified Listener

Hear sounds around you like never before! Two built-in mikes and dual-channel amplification maintain a natural sense of direction. Great for listening to nature sounds. Hi-Boost control adds crispness and clarity. Volume control. 4 x 2 1/4 x 7/8". Neck cord. Requires 2 "AA" batteries and headphones with 1/8" plug. **33-1093** **21.95**



Choose from our big selection of stereo headphones on page 51



PZM™-Type Microphone

Realistic PZM. Uniquely designed to respond to sound pressure so that it cuts echo effects while increasing clarity and range. Excellent for stage performances, pulpits, executive board rooms and conferences. 20-18,000 Hz response for superb audio. 600 ohms. 5 1/2 x 4 7/8" metal base. Includes 18-ft. cord, 1/4" plug. Requires "AA" battery. **33-1090** **52.95**



Portable Recorder Mikes

Each mike has an on/off switch to start and stop recorder, plus a 1/8" audio plug and 3/32" remote plug.

(1) Omni Electret. 20-13,000 Hz. With 6 1/2-ft. cord, stand, windscreen, battery. **33-1060** **18.95**

(2) Omni Dynamic With Windscreen. 100-11,000 Hz. 6 1/2-ft. cord. Low impedance. **33-2001** **11.95**

(3) Budget Dynamic. **33-1067** .. **4.95**



Stereo Microphone

Record in stereo with a single microphone! Dual unidirectional heads are adjustable up to 180° apart for best stereo separation—perfect for recording ensembles. 50-15,000 Hz response. Dynamic. Flip-up stand. Slip-on foam windscreens reduce wind and breath noises. One 6 1/2-ft. cord with dual 1/8" plugs. Requires "AA" battery. **33-1065** **28.95**

F.Y.I. Facts About Pickup Pattern Choice and XLR Adaptability



Omni



Uni

OMNIDIRECTIONAL. This wide pickup pattern provides equal sensitivity to sound in all directions. Excellent for meetings.

UNIDIRECTIONAL or CARDIOID. Single-direction pickup pattern reduces feedback and background noise. Ideal for stage use.

XLR. Shielded 3-wire connector/cable found on low-impedance mikes; reduces noise on cable runs 45 ft. or more. See XLR adapters on next page, cables on 105.





Three-Channel FM Wireless Mike System

Hands-free mikes for three users! Wireless receiver has volume control for each mike—works like a mixer. Line and mike level outputs. UL listed AC (or DC adapter, extra). Each transmitter has power on/off and mute control, lapel mike, belt clip and requires "AA" battery. (TSP) 32-1228 139.95

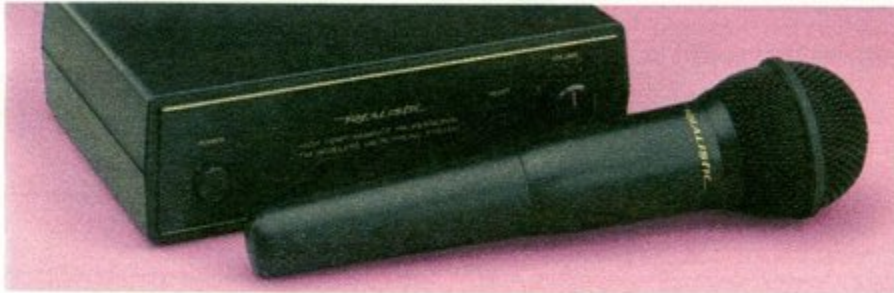

Pro-Quality Handheld FM Wireless Mike

No cord to get in the way—ideal for singers, orators, outdoor activities. Crystal-controlled 170-MHz operation for performance that professionals expect. Receiver has output level control, line and mike-level outputs, and is UL listed for AC operation. Dynamic mike has on/off switch and requires 9V battery. (TSP) 32-1224 139.95



Camcorder FM Wireless Mike

Record from up to 200 feet away with drift-free, noise-free sound. Transmitter has belt clip, tie-clip mike, cord. Receiver has hi/low volume, monitor, earphone, 1/8" camcorder mike cable, shoe mount. Requires 2 9V batteries. (TSP) 32-1226 69.95



Hands-Free FM Wireless Mike System

200-foot range, plus crystal-controlled clarity. 70-10,000 Hz. Standby/talk switch, cord mike, tie clip. Requires "AA" battery. Receiver has line/mike-level outputs. UL listed AC (or DC adapter, extra). (TSP) 32-1221 59.95

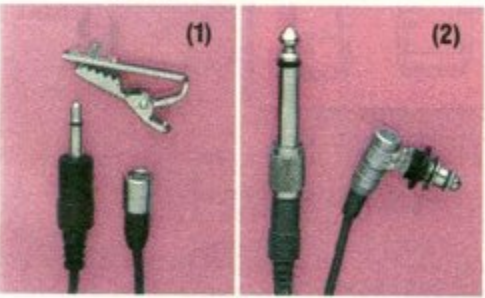

Hands-Free Electret Mikes

(1) **Tie-Clip Omni.** 50-15,000 Hz response. 1000 ohms. With 3-ft. cord., 1/8" plug, battery. 32-1052 21.95

(2) **Tie-Pin Super-Omni.** 7/8" long. 50-18,000 Hz. 800 ohms. 6 1/2-ft. cord, 1/8" plug, 1/4" adapter, pin, battery. 33-1063 28.95



Wireless FM Mike

Palm sized, yet transmits to any FM radio or receiver for remote taping, PA, or monitoring a child's room. Tunable 88-108 MHz. Up to 200 feet outdoors, 100 feet indoors. On/off switch. Spring-clip on back. Requires #23-1521 battery. 33-1076 19.95

Wireless microphones and a full line of mike accessories by Realistic



Folding Mike Stand

Extra sturdy for any type of engagement. Portable stand adjusts from 32-57". Fan-fold legs fold up for quick transport or storage in a closet or car trunk. Non-slip rubber feet. Standard 5/8" thread to fit mike stand adapters. 33-325, 24.95

Heavy-Duty Mike Stand

Professional features for stage, studio or even the home. Sturdy cast-iron base provides stability. Chromium-plated tube adjusts from 34" to 64" high. Standard 5/8" thread for mike stand adapters. 33-320 22.95



31" Boom Adapter

Studio-type mike holder—ideal for professional or home audio/video recordings, singers and musicians. Attaches to mike stand to position mike where you need it. Adjustable length and angle, built-in counterweight. Standard 5/8" thread. 33-344 15.95



Foam Windscreen

Soft screen fits over microphone head to help cut annoying wind and breathing noises and enhances clarity for a more professional sounding performance. A must for recording and singing. Fits most mikes. 33-373 1.79

Microphone not included

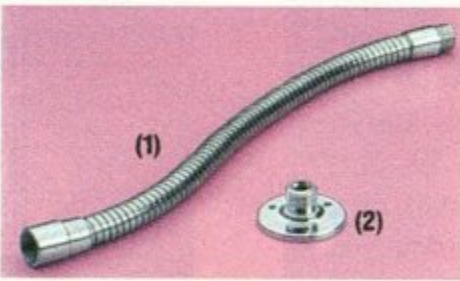

Mike Accessories

(1) **13" Gooseneck.** Plyable metal flex-hose bends and moves to your will to let you adjust mike to any position. 33-330 5.99

(2) **5/8" Screw Flange.** For mounting of gooseneck on desk or console. 33-332 2.59

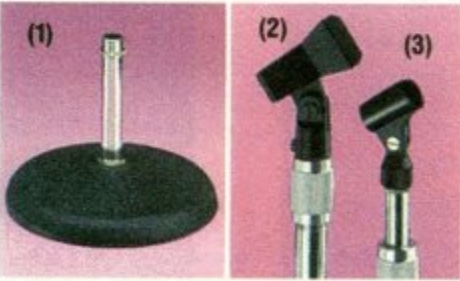

Mike Stand Adapters

(1) **Desktop Mike Stand.** Cast iron base, padded feet. 4" chromed tube. Std. 5/8" thread. 33-370, 6.99

(2) **Clamp-On Adapter.** Spring-action mike release. 33-372, 4.29

(3) **Slip-In Adapter.** Fits standard thread. 33-371 2.59



1/4" XLR Adapters

(1) **A3F.** Balanced mike/line to high-impedance input used in professional-type sound systems. 274-016 11.99

(2) **A3M.** Connects high-impedance mike to balanced line or system. 274-017 11.99

Keeping your home safe and secure

Crime in America has been rising at a dramatic rate, so making the home more secure has been a growing concern for many people. Understanding this concern, Radio Shack has long worked to bring you highly reliable and affordable security devices and systems to protect you, your home, and your family. From small window-alarm devices to whole-house wired systems, come to Radio Shack for your security needs. You'll find a wide selection and friendly advice—only at Radio Shack.

Protecting the Home Front

Adding a Security System greatly reduces the risk of becoming a victim of burglary, especially daytime robberies. Most thieves hit several places in one area to make it worth their while, so they tend to stay away from homes that have a security system. Studies show that homes without alarms are six times more likely to be burglarized than a home with one. And walking in on a burglary in progress can turn into a dangerous situation—nearly a third of all assaults are committed by burglars.

A security system not only reduces the risk of being victimized, but also gives you peace-of-mind. Deterrence is the name of the game—do everything possible to protect yourself. Install an alarm, then apply warning decals to your doors and windows so burglars will know you are protected.

Passive Infrared Motion Detectors for Protecting Selected Areas

Infrared sensors, considered the "eyes and ears" of an alarm system, detect both body heat and motion within a designated area. If an intruder enters the infrared "field", it sounds the alarm system. Passive infrared detectors are usually installed in large rooms such as living rooms or dens, plus entryways and other places considered difficult to install conventional-type magnetic sensors. Most infrareds can be adjusted to accommodate household pets.

Radio Shack carries several different models of infrared sensors. For individual protection, we have a Motion-Sensing Alarm (next page) that can be set up in small rooms to guard doorways and windows—ideal for traveling or dorm rooms. We also offer a Stand-Alone Infrared Sensor Alarm System that's ready to go, right out of the box, to protect smaller homes, apartments and condos. It has a loud, built-in alarm, and you can also expand on the system with external sirens, digital "keyless keypads" and more. And of course, we carry infrared sensors that supplement Wired Home Alarm Systems and our Wireless Plug 'n Power® Security Systems. So, whatever system you choose, keep in mind that using infrared sensors can save you installation time and money.

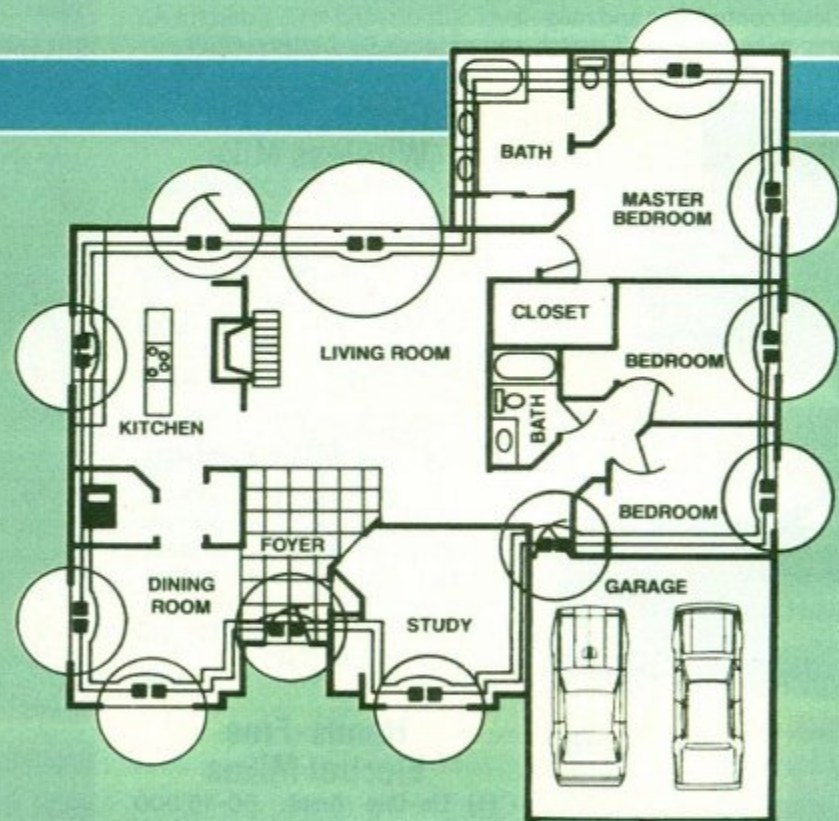
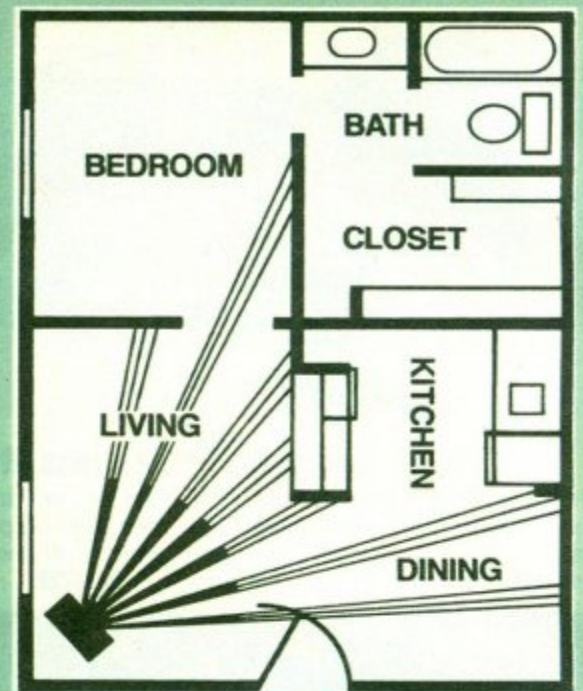

Wired Burglar Alarm Systems to Protect Your Entire Home and Your Family

Although wired alarm systems take a bit more time and effort to install, they still tend to be the most reliable, maintenance-free and lowest costing alarm systems to cover every door and window. One of the best features of a hard-wired system using a Control Center, is that it can be easily expanded to fit the needs and situations of any home. The typical system consists of three essential sections; the control center (panel), protective sensors usually installed on doors and windows, along with an infrared sensor to guard entryways, and a siren. A digital keypad or key lock is used to control arming and disarming of the system. And you can easily add an automatic security phone dialer, strobe lights, panic buttons in case of emergencies, remote light flashers, backup battery and more. If you do decide to put in a wired security system, it is wise to draw a diagram of your home so you can determine how much wire and what accessories you need, in advance, saving you time and possible rework. For more information, ask a Radio Shack sales associate.



NEW! Infrared Motion Alarm System. Protect home or office—detects motion and body heat in a 30 × 30-ft. area with six upper and three lower zones. Alarm auto-resets after five minutes. Has entry/exit delay. Terminals for adding external alarm, remote arming switch and security dialer. 7⁷/₈ × 2⁹/₁₆ × 6¹¹/₁₆". UL listed AC. Backup requires 8 "C" batteries. (TSP) **49-320** **99.95**



Security Auto-Dialer. Triggered by an alarm system or touch of a button. Dials up to three phone numbers, plays message to alert police, fire, physician. Large, easy-to-find "panic" button. For any pulse or tone line. UL listed AC. Backup requires 3 "AA" and 4 "C" batteries. FCC registered. 2³/₄ × 9 × 6³/₄". (TSP) **49-433** **99.95**



Infrared Photorelay Alarm/Announcer. Shoots an invisible beam of light to reflector (up to 50 feet away). Buzzer sounds if beam is interrupted to serve as an alarm or as an announcer. Add backup battery (requires 12V lantern type), strobe light, siren or auto-dialer. May be used in conjunction with a central alarm system. 4¹/₈ × 3 × 7¹/₄". UL listed AC. (TSP) **49-310** **69.95**



NEW! Outdoor Infrared Dual Floodlight. For driveway or entry—detects body heat or motion to surprise intruders and provide light for safety. Sensitivity and range controls, adjustable to stay on up to 15 minutes. Weather-resistant. UL listed AC. **61-2605** **24.95**



Home Smoke Alarm. Dual-ionization chambers monitor air for smoke or invisible combustion particles. "Hush" button silences alarm when "safe" smoke causes nuisance alarms. Test and reset button. Heavy smoke overrides reset. 5¹/₄" dia. × 2". UL listed. **49-458** **11.95**

Affordable security for your home or office



New! Video Surveillance System

- Safe and secure way for you and your family to answer the door
 - Keep watch over children in the backyard, play room or bedroom
- SAFE HOUSE VSS-100** A complete, affordable and ready-to-use system you can set up to monitor any activity in remote locations. Camera can be easily installed almost anywhere with the supplied mounting bracket while the monitor can be set up in the kitchen, bedroom or near the doorway. Install camera to check out visitors at the front door or keep track of what might be going on in the front yard. Includes CCTV high-resolution camera with 16mm lens and built-in microphone, 9" B&W monitor, 60-foot connecting cable. Jacks for VCR (optional) input/output. UL listed AC. **49-2500, 299.95**
- 6-Ft. VCR Adapter Cable.** (CMC) **49-2510** **7.95**
100-Ft. Camera Extension Cable. (CMC) **49-2520** **39.95**

Door Alarm and Chime

(1) Simple-to-install, arms with keyboard code—no wiring required. Intruder alarm, chime to announce visitors. With magnetic trigger. 6⁵/₈ × 2³/₄ × 1¹/₄". Requires 9V alkaline battery. **49-422** **24.95**



Door or Window Alarm

(2) Electronic alarm mounts quickly with screws or double-sided tape. Key-operated on/off switch. Entry/exit delay. Only 5¹/₈ × 2¹/₄ × 1¹/₈". Requires 9V alkaline battery. **49-421** **11.95**



Motion-Sensing Alarm

(3) Easily mounts on door or window to warn of intruders. Alarm auto-resets after one minute. 4¹/₄ × 2¹/₄ × 1¹/₈". Requires 9V alkaline battery. **49-419** **11.95**



Powerhorn® Jr. Alarm

(4) Inexpensive alarm mounts on door or window to protect you and your home from intruders. Includes hardware. Requires 2 "AA" batteries. **49-494** ... **3.69**



Wired-type security equipment

SAFE HOUSE® wired-type equipment is engineered to provide perimeter coverage, the kind of protection that professionals install and recommend.

Our in-depth selection makes it easy for you to install a security system perfect for your needs. Radio Shack is America's Security Supermarket!

F.Y.I.

ALARM CONTROL CENTER. This is the "brain" of a wired-type security system. All of our control centers feature a steel case and provide space for adding rechargeable backup batteries. We include an expertly prepared manual that will help you plan and install your system.

SENSORS. These are the "eyes" and "ears" of a wired-type security system. You can add sensors anytime to increase your system's coverage.

SIRENS. We have a wide selection of sizes and a strobe light, shown on the facing page, plus an automatic phone dialer, described on page 79.

ZONED COVERAGE. Here's an example: You can set up one or more zones to monitor entry points and other zones to monitor indoor areas. When you're home, you can turn off the indoor zones while leaving the entry zones active.

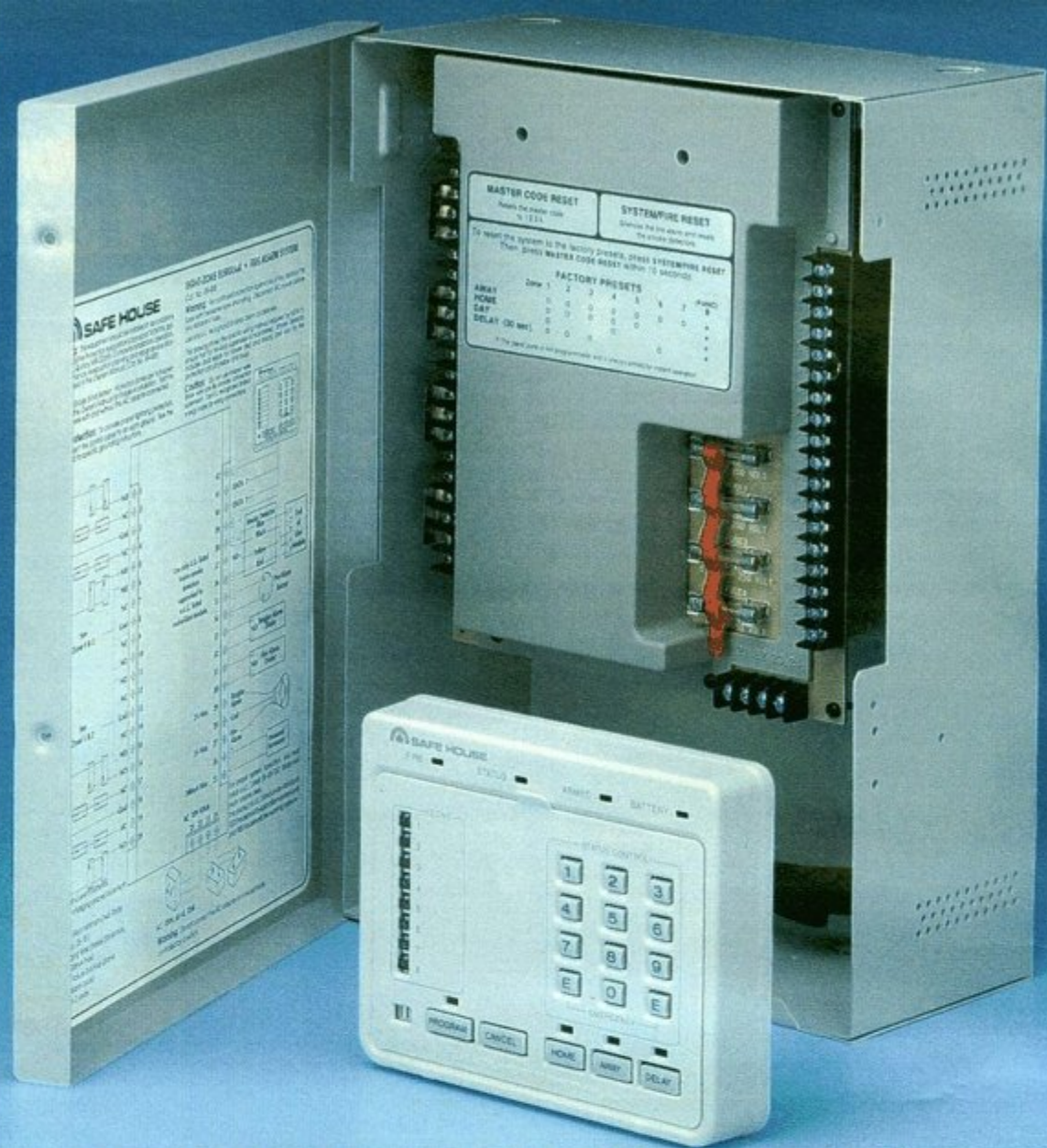

New! 8-Zone Burglar and Fire Alarm Control Center

- Remote keypad included ■ Lets you turn system on/off with a code you program
- Provides up to seven burglar alarm zones, "panic" zone and a fire alarm zone

Loaded with professional features! The seven independent zones are totally programmable. Each may be set for entry/exit delay or instant operation. The always-armed panic zone allows you to manually sound the alarm. You can add a tamper switch to guard valuables, up to three more remote keypads, a phone autodialer to call for help, and virtually any security sensor or siren. Included owner's manual is easy to understand and helps you plan an effective system. 13 x 9 1/2 x 3 3/4". (TSP) 49-485 . . 199.95

NEW! Extra Remote Control Keypad. 49-484 44.95
6V Rechargeable Backup Battery. Two required. 23-181 Each 10.95

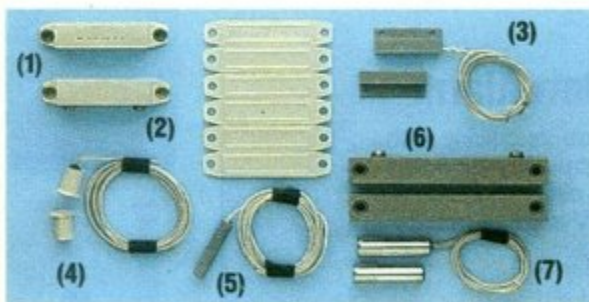

Door and Window Contact Switches

Fig.	Description	Cat. No.	Price
1	Door/Window Switch (Normally Closed)	49-495	3.99
...	Door/Window Switch (Normally Open)	49-512	4.95
2	Spacers for Above	49-519	6/1.29
3	Mini Magnetic Switch (Normally Closed)	49-497	3.99
4	Press-Fit Switch (Normally Closed)	49-505	5.99
5	Concealed Mag. Switch (Norm. Closed)	49-496	3.99
6	Wide-Gap Switch (Normally Closed)	49-499	6.29
7	Threaded Mag. Switch (Norm. Closed)	49-503	6.99

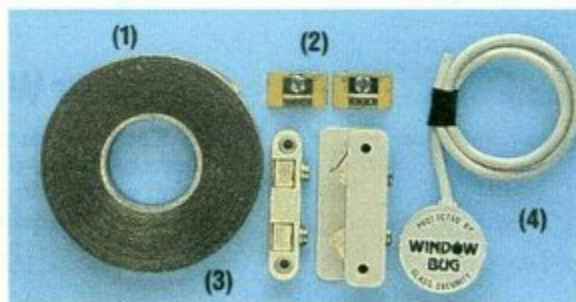

Foil, Contacts and Breakage Sensor

- (1) **Window Foil.** Self-adhesive. Attaches to glass. Provides normally closed circuit. 120-foot x 3/8" roll. 49-502, 6.79
- (2) **Self-Adhesive Foil Connectors.** Use for a neat and reliable foil installation. 49-504 3 Pair/2.59
- (3) **Sliding Window/Door Contact.** For use with foil or glass breakage detector. Allows normal use of window or door. Mounts on window or door and its frame. 49-518 . . 3.99
- (4) **Glass Breakage Detector.** Protects up to 32 square feet of glass. Works with normally open or normally closed circuits. Easy hookup. 49-516 7.95
- NEW! **Garage Door Magnetic Contact Switch.** Normally closed. (CMC special order) 49-570 21.95



Alarm Switches and Vibration Detector

- (1) **Panic Switch.** Use to manually trigger alarm in an emergency. Normally open. Press to close circuit. 49-517 1.49
- (2) **Contact Switch.** For window or door frame. Normally closed. (Opens when door or window opens.) 49-513 1.29
- (3) **Tamper Switch.** Use to protect a valuable item such as a painting, TV, VCR or stereo. Normally open. 49-528 . . 1.59
- (4) **Jumper Cord.** Perfect for adding protection to doors with glass panels. 49-548 4.19
- (5) **Vibration Detector.** Adjustable sensitivity. Normally closed. (Circuit opens when activated.) 49-521 3.95

New! 4-Zone Burglar and Fire Alarm Control Center

Protect your family and property! This control center is perfect for a mid-size home or apartment. It provides up to four independent zones for intruder protection, a 24-hour fire-alarm circuit, and a separate circuit for adding a panic button or tamper switch. You can also connect a phone autodialer to call for help when you're away. Variable entry and exit delays let you come in and leave without triggering alarm. Front panel has LED indicators for zone status, battery status, and power on/off. Included installation manual helps you plan your system and select the accessories. 13 x 9 1/2 x 3 3/4". (TSP) 49-475 149.95
6V Rechargeable Backup Battery. Two required. 23-181 Each 10.95

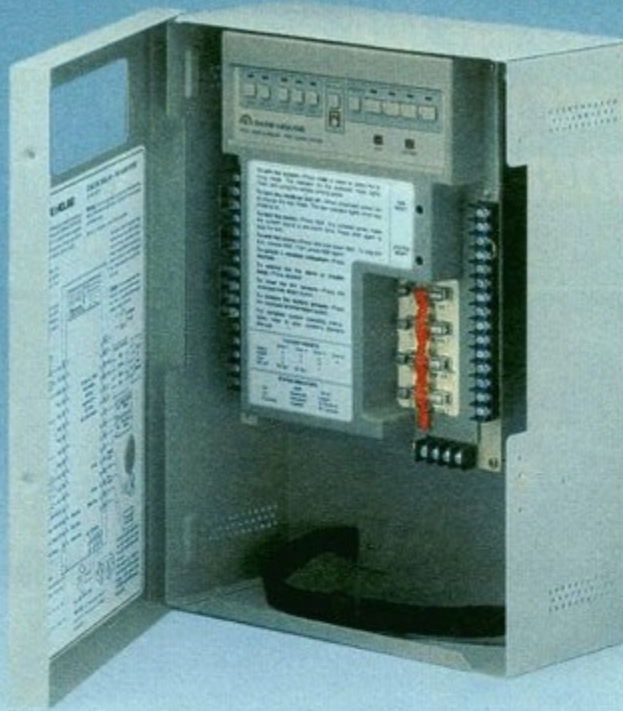

Add protection Anytime with our SAFE HOUSE® accessories for wired-type alarms

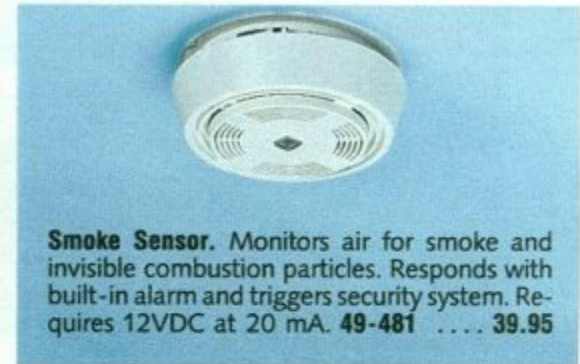

Smoke Sensor. Monitors air for smoke and invisible combustion particles. Responds with built-in alarm and triggers security system. Requires 12VDC at 20 mA. 49-481 39.95

Two-Zone Control Center

Effective perimeter-type protection at minimum cost! This is a great choice for a small home or apartment. You can add any of the sensors shown on page 80, a siren or strobe, a keypad or key switch for remote arming and disarming, even a phone autodialer. Provides two independent zones, one with instant response and another with adjustable entry/exit delays. It has a separate circuit for a panic switch or a tamper sensor. Front panel LEDs show you the system's status at a glance. Handy battery and siren test buttons. Battery backup system. 11 7/16 x 8 1/4 x 3 9/16". (TSP) 49-450 99.95
6V Rechargeable Backup Battery. Two required. 23-181 Each 10.95



Motion Sensor



Passive infrared device senses body heat and motion. It opens circuit to trigger security system. Dual-element design virtually eliminates false alarms. Requires 12VDC at 20 mA. 49-550 59.95

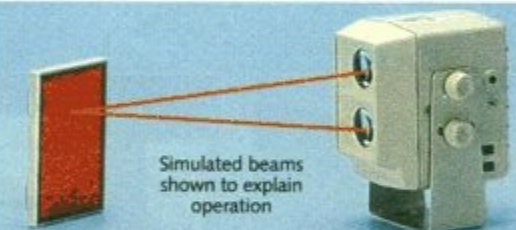

Infrared Photorelay Sensor. Invisible beam guards an entry or area up to 30-ft. across. Works with normally open or closed circuits. Requires 12VDC at 60 mA. 49-551 .. 37.95

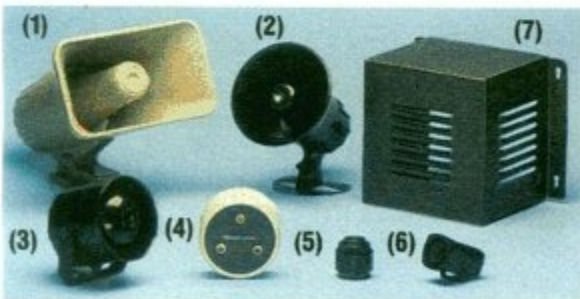

Security Sirens, Buzzer and Enclosure

Fig.	Description	DC Volts	Amps	Cat. No.	Each
1	Hi-Power 2-Sound Siren	4-12	1	49-525	41.95
2	In/Outdoor 2-Sound Siren	12	0.5	49-488	19.95
3	Hi-Efficiency 2-Sound Siren	12	0.33	49-487	22.95
4	Indoor 2-Sound Siren	12	0.36	49-490	12.95
5	Piezo Buzzer (Pre-Alarm)	4-28	0.2	273-068	8.49
6	Hi-Efficiency Siren	12	0.24	49-489	10.95
7	Siren Enclosure	49-486	12.95



Strobe, Interface, Wire and Decals

- (1) **Strobe Light.** Connects to security system. Super-bright flashing light helps emergency workers locate your home quickly. Requires 12VDC at 0.2 amp. 49-527 21.95
- (2) **Universal Plug 'n Power® Interface.** Allows alarm system to activate wireless Plug 'n Power equipment. See page 84. (CMC special order) 61-2687 19.99
- (3) **Security Alarm Wire.** 22-gauge, stranded, 2-conductor. 300 Feet. 278-863 ... 21.99 100 Feet. 278-862 ... 7.99
- (4) **Warning Decals.** Low-cost deterrent. Warn potential intruders that your property is protected by a security system. Vinyl adhesive. 49-507 Pkg. of 4/1.19



Digital Keypad

No need to carry keys to turn alarm on/off. Just enter the 4-digit personal code you've set. Status LEDs. Tamper sensor. For indoor use. Requires 16VDC at 70 mA. 49-535 22.95
For use with 49-450/475



Key Switches

- (1) **Remote Switch Plate.** Requires 6 or 12VDC. 49-524 6.95
- (2) **Momentary Type.** 49-523 9.95
- On/Off Type.** Locks in off or on position. 49-511, 9.95
- (3) **Covered On/Off Locking Type.** 49-515 ... 4.79
For use with 49-450/475

The easy way to control all the lights and appliances in your home from one location... without running a single wire



Plug 'n Power®

Switch on lamps with a touch of a single button!

Turn appliances on/off anywhere in your home!

Control outdoor lights for safety and security!

Did you turn off all the lights?

With a flick of a switch, you can control everything in your home. It's simple—the Plug 'n Power remotes plug into AC outlets to control the power to lights or appliances. The Command Center uses your home wiring to send signals to the remote modules to control living room lights, TVs, fans, stereos, most anything. It's fast, it's easy—it's Plug 'n Power!

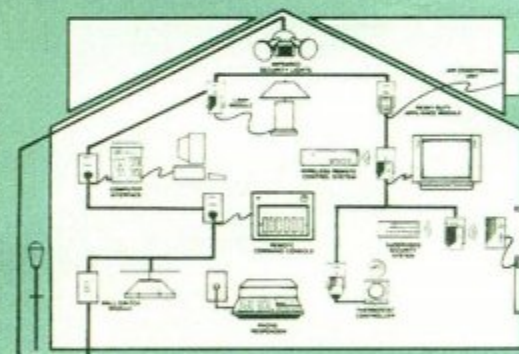

Easy to install—just plug in and it's ready to work!



F.Y.I.

REMOTE MODULES. Receive signals from controller to remotely turn on/off devices in your home. Lamp modules and dimmer modules control incandescent lights (bulb-type lights). Appliance modules are specially rated to control extra power requirements needed to run the motors and heating elements found in coffee makers, ceiling fans, air conditioners and more!

COMMAND CENTER/CONTROLLERS. Simply plug into your AC outlet for convenient control of all the remotes in your home. Depending upon the

controller, you can take control of ten individual remotes or groups of remotes. Some models even have a built-in timer—just what you need to give your home that lived-in look while you're away or automate your air conditioner for maximum energy savings and comfort.

HANDHELD CONTROLLER. Works in conjunction with Command Centers to control your remote modules from anywhere in your home—living room, bedroom, garage, even in your own driveway.

REMOTE WALL SWITCH. Works like an ordinary wall switch and with the controller to turn on/off lights without having to rewire your home.



New! Plug 'n Power® Keychain Remote and Wireless Wall Switches

(1) Keychain Remote System. Be safe—never enter a dark home again. Turn front or interior lights on/off from driveway or porch. Remote sends a wireless signal to a lamp or appliance plugged into the included transceiver module. Remote can also signal transceiver to retransmit on/off codes over house wiring to control other Plug 'n Power modules (sold separately). Requires 2 "AAA" batteries. **61-2663** **24.95**

(2) 4-Button Wireless Wall Switch. The instant wall switch that mounts anywhere—without rewiring! Ideal for den, living room or bedroom to turn on/off fans, overhead lights and hard-to-reach lamps. Unique switch utilizes transceiver module above (61-2663) to control additional Plug 'n Power modules anywhere in your home. Requires 4 "AAA" batteries. **61-2664** **14.95**

2-Button Wireless Wall Switch. Requires 4 "AAA" batteries. (CMC) **61-2562** ... **12.99**

3-Button Wall Switch With Dimmer. Requires 4 "AAA" batteries. (CMC) **61-2563**, **15.99**

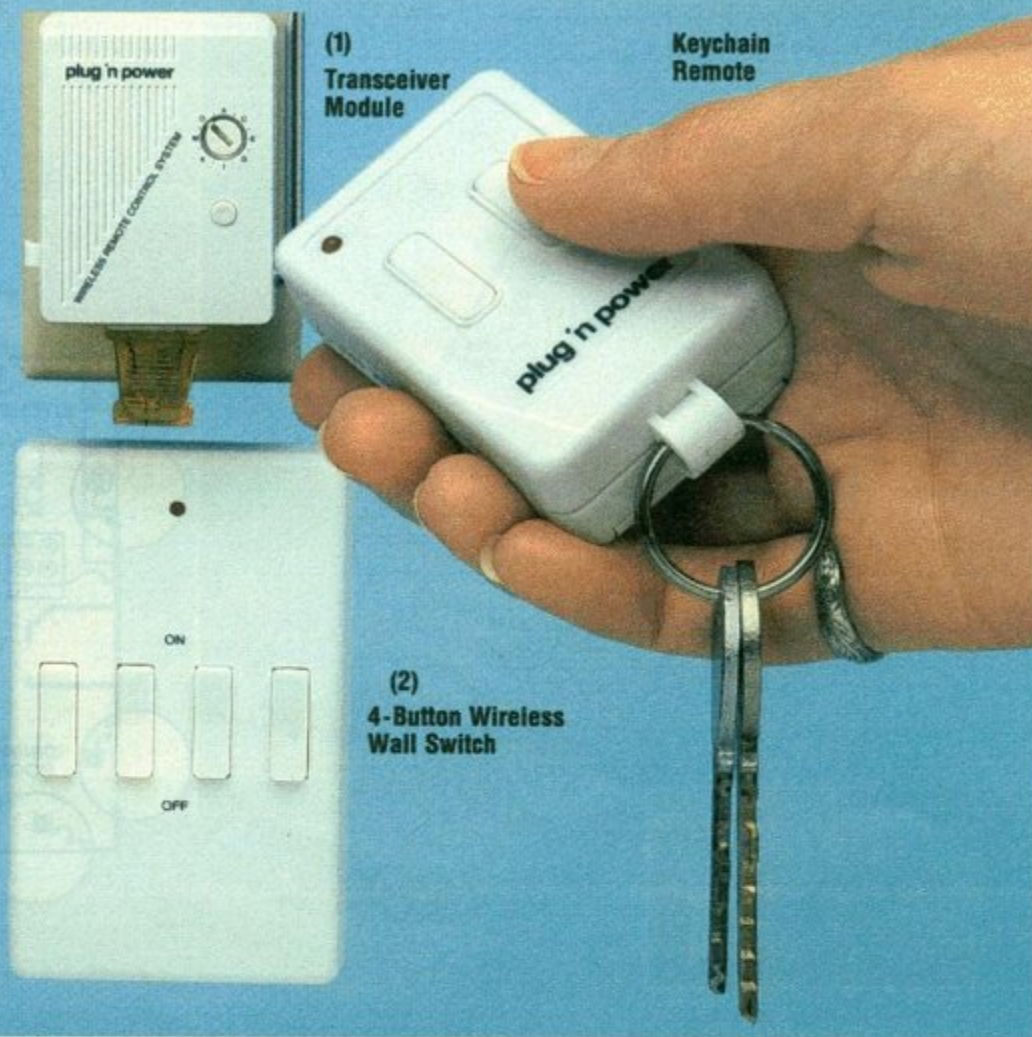

(1)
Transceiver
Module

Keychain
Remote

(2)
4-Button Wireless
Wall Switch



(1)

(2)

(3)



(1)

(2)

(3)

(4)



(1)

(2) Installs with just a screwdriver

(2)

Wireless Remotes Put Control in the Palm of Your Hand

(1) Wireless Remote Control and Light Dimmer System. Turn on/off and dim/brighten lights with a touch of a button—even in your driveway. Plug-in receiver has one 15A outlet for lamp or appliance. Add plug-in modules to remote-control up to 16 sets of devices. Remote requires 4 "AAA" batteries. **61-2676** **39.95**

(2) Extra Remote Controller. For above and 61-2611/2609 systems. **61-2560** **19.95**

(3) NEW! Infrared Mini Controller. Uses Universal AV Controller (15-1905) to control lights and appliances. Commands up to eight remote modules. Special order (CMC). **61-2658** **39.99**

NEW! Universal Remote AV Controller. (See page 57) **15-1905** **59.95**

Command Centers and Remote Controller/Timers

(1) Mini Command Center. Controls up to eight sets of remote modules from bedside table or living room. Dim/brighten, control appliances. **61-2677** **12.95**

(2) "Sundowner" Controller. Same functions as Fig. 1 plus a built-in photocell sensor for automatic dusk to dawn light control. Special order (CMC) **61-2616** **22.99**

(3) Remote Controller/Timer. Use with remote modules to automate fans, air conditioners, lights, TV, more. Program daily on/off times or operate manually. Doubles as a digital alarm clock. Requires 9V backup battery. **61-2670** **29.95**

(4) 16-Button Controller. Controls up to 16 sets of modules. (CMC) **61-2672** ... **24.99**

Plug 'n Power Remote Modules and Wall Switches

(1) On/Off Appliance Module. Use with timer to control your coffee maker, fan and more so you can relax! Rated 15 amps, 1/3 HP for motors, 500W for incandescent lamps. **61-2681** **12.95**

Universal Appliance Module. As above but with 3-prong plug/outlet. **61-2684** .. **13.95**

(2) Wall Switch. On/off, dim/brighten. 500W, incandescent only. **61-2683** ... **12.95**

Lamp Dimmer Module. Rated 300W, incandescent lamps only. **61-2682** **12.95**

Wall Outlet. Has one remote-control outlet and one standard outlet. **61-2685** ... **15.95**

3-Way Wall Switch. Remote on/off and brighten/dim. **61-2686** **15.95**

Companion Switch for 4-Way Installation. (CMC). **61-2607** **7.99**



Door/Window Sensor (extra)

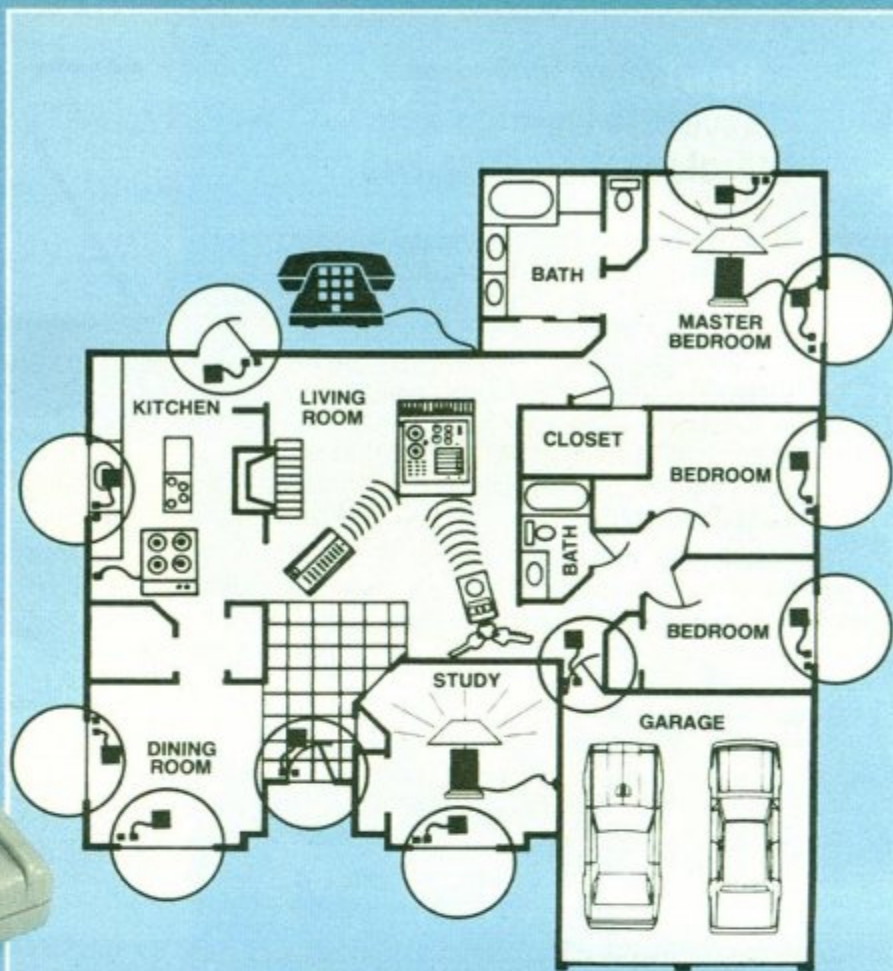

New! Supervised Wireless 8-Zone Security Console With Voice Dialer

Convenient. A do-it-yourself 8-zone security console that can be installed anywhere in just minutes without running a single wire! Just plug it in to any AC outlet, set up remote sensors (extra), and it's ready to work. **Pro-Quality Protection.** Provides 24-hour security to protect your home and family. Receives signals from the Plug 'n Power door/window and infrared sensors. When a sensor is tripped, the Console sounds the built-in super-loud alarm and flashes lamps (connected to lamp modules) to scare away any intruders!

Automatic Dialer. Dials up to four phone numbers to notify that a break-in is in progress. The person called can then listen to your home through the Console's microphone. Program dialer to call friends or family and avoid monitoring fees. **Remote Controlled.** Remote arms/disarms system in the "away" or "home" mode (with or without motion detectors armed). Turn on/off up to four light/appliance modules with a single button. **Supervised.** Constantly checks status of each

sensor and notifies you when battery is weak. **Expandable.** Completely compatible with all Plug 'n Power equipment. Add up to 16 door/window sensors (61-2612, 14.95; see inset) anywhere in your home, wireless motion detectors, keychain remote, remote sirens, indoor light control modules—even outdoor floodlights (61-2604, below). Wireless console and remote require 9V battery. UL listed AC. (TSP) 61-2609 99.95
Extra Remote Control. (CMC) 61-2561 24.99

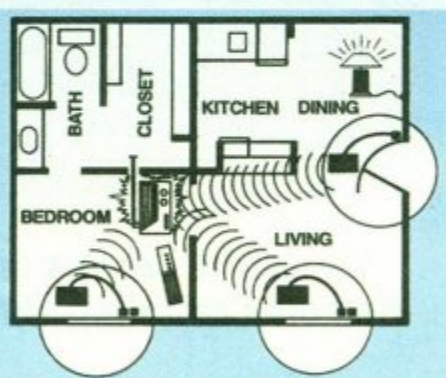
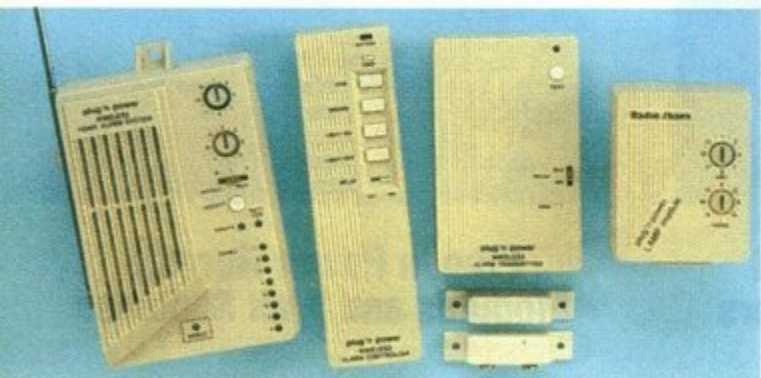

Motion-Sensing Outdoor Floodlight

Plug 'n Power Supervised Security System With Remote Control

You get pro-quality supervised security and convenient control with no-tools installation—it couldn't be easier! Use the handheld remote anywhere in your home—press a button to arm/disarm the system, press another to turn lamps on and off. When an intruder opens a protected door or window, a loud 85 dB siren sounds and the lamp module flashes a lamp to attract attention and scare off intruders!

Door/window sensors are supervised—they check themselves automatically and report to the receiver. LEDs tell you if a battery is weak or if a window or door is open. Add more sensors and motion detectors to expand your system.

Basic system includes all above: remote, receiver/siren, one door/window sensor and one plug-in lamp flashing module. Receiver, door/window sensor and remote requires 9V battery backup. (TSP) 61-2611 79.95

Extra Handheld Remote. (CMC) 61-2615 24.99
Extra Door/Window Sensor. 61-2612 14.95

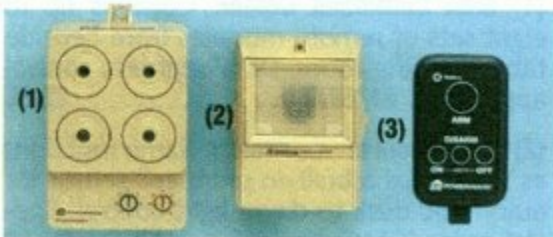

Plug 'n Power Security Accessories

- (1) **POWERHORN® Remote Siren.** 110 dB. Plugs into any indoor AC outlet. No wiring. (CMC) 61-2613 49.99
- (2) **Infrared Motion Detector.** Sets off system when it detects heat and motion. Wireless. (CMC) 61-2614 59.99
- (3) **Miniature Keychain Remote Control.** Lets you arm/disarm system, turn lights on/off as you enter and leave. Works as "panic" button, too. (CMC) 61-2618 ... 24.99

Plug 'n Power Remote-Switching Floodlights. Lights come on when sensor detects motion. Works independently or you can set it to turn on indoor lights as dusk and other lights when it detects motion—just add Plug 'n Power lamp modules. Plus, you can use any Command Center to control floodlights manually. Installs on standard electrical box. Bulbs not included. (CMC) 61-2604 49.99

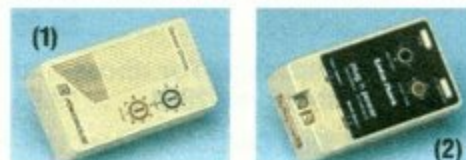

- (1) **Remote Chime/Beeper.** Use with 61-2604 as remote door bell. (CMC) 61-2656 24.99
- (2) **Universal Interface.** Connects to alarm system, contact switch or other sensor. Turns on or flashes lights connected to modules when alarm or sensor trips. (CMC) 61-2687, 19.99

Automate your entire home with your computer!

Plug 'n Power Computer Interface With DeskMate® "Automatic House" Software

- Simply program the interface, detach it and it's ready to work—doesn't tie up your computer
- Easy to use—controls up to 128 different timer events and up to 256 Plug 'n Power remote modules

Incredibly simple—use the power of your computer to set up automatic control for lights, appliances, heating and cooling. By utilizing DeskMate 3.0, the Automatic House software helps you make an on-screen floor plan of your home and lets you schedule your remote Plug 'n Power modules for different on/off times for each day of the week.

Program lights and appliances for your daily routine so that when you wake, the lights come on, and coffee is made. Schedule lights, TV and radios to turn on/off while you're away — a great crime deterrent. Includes hookup cable. Requires DeskMate 3.0, mouse, remote modules, and 9V battery for backup. (CMC) 61-2617 69.99



These Plug 'n Power Remote Modules Make Your Living Easier



Call Home to Turn it On and Off

Telephone Responder. Lets you call home to control up to 10 lights or appliances by entering simple commands on any Touch-Tone keypad. When you're home, you can use the Telephone Responder as a manual Plug 'n Power control center and even set it to flash selected lights when your telephone rings. (CMC) 61-2692 79.99

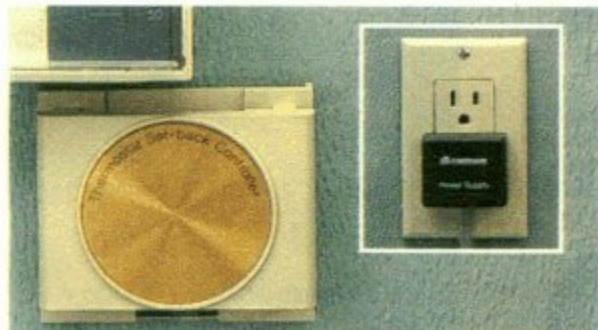

Control Your Thermostat by Remote

Set-Back Thermostat Control Module. A great way to reduce fuel costs for your central heating and air conditioning system. Set the controller to automatically set-back the temperature. **Conserve energy** when you go to bed at night, and then restore it to a more comfortable level when you get up in the morning. It's simple to install and requires no rewiring of your existing thermostat. Works with any kind of thermostat. Save energy and money at the same time. UL listed AC power supply. Requires Plug 'n Power Appliance Module (sold separately). (CMC) 61-2689 19.99

How Would You Like to Control Everything in Your Home by Remote?

You can, easily! With Plug 'n Power wireless modules, you can turn on/off lights and appliances by remote control or with a timer system—without installing wires! **How it Works.** The command center sends signals through your AC wiring to remote receiver modules to dim or turn on/off lights, turn on the TV or thermostat, or even arm a home security system. And with a hand-held remote, you can do it all without ever leaving your chair or bedroom—it's that simple.



Remote Control Sounder/Actuator

Operates as a relay to switch on/off any type of low-voltage load systems — sprinklers, low-voltage outdoor lighting, automatic draperies, auto-dialer, or pause control on a VCR or video camcorder used for security surveillance. **Built-in beeper** can be used as an intruder annunciator by linking it with Plug 'n Power motion-sensing dual-flood-light system (61-2604, see previous page). Provides continuous or momentary operation, compatible with all Plug 'n Power controller/timers. Rated 30VRMS at 100VA. (CMC) 61-2688 18.99

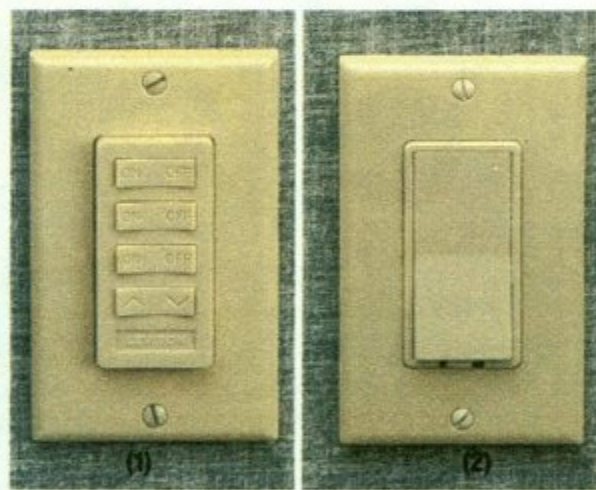

Commercial-Type Switches and Modules To Increase Plug 'n Power Capabilities

- (1) **Wall Mounted Command Center.** Flush mounts in wall in standard electrical box. Turns on/off or dims up to three remote light modules or groups. (CMC) 61-6319 89.99
 - (2) **Wall Switch/Dimmer Controller.** Installs in a standard electrical box. (CMC) 61-6381 59.99
 - Fluorescent Light Controller Switch.** Control lights and appliances that shouldn't be dimmed. Installs in standard electrical box. (CMC) 61-6291 64.99
 - Hidden Remote Dimming Module.** Can be attached inside fixture with supplied self-adhesive strips. (CMC) 61-6376, 64.99
 - Hidden Remote Fluorescent Light Module.** Self-adhesive strips. (CMC) 61-6375 64.99
 - Signal Bridge Coupling.** Ensures Plug 'n Power command signals are strong and sufficient throughout your home. 120/240V. (CMC) 61-6299 59.99
 - Noise Block.** Can be wired on load side to reduce electrical noise from remote modules, low-voltage ballasts or any noise-generating sources. (CMC) 61-6287 39.99
 - Plug-In Noise Filter.** Helps eliminate electrical noise that may interfere with command center signals. (CMC) 61-6288, 39.99
 - Wall Switch for Incandescent Lights.** (CMC) 61-6651 ... 36.99
- Some devices may require installation by a licensed electrician.

Electrical Devices Designed to Make Life a Little Easier

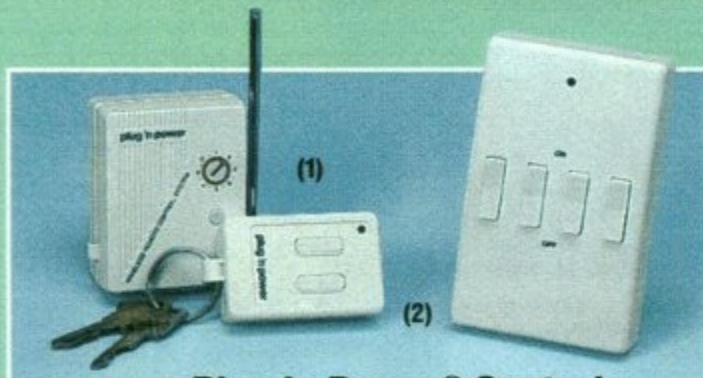

New! Plug 'n Power® Controls

(1) **Keychain-Remote 2-Channel Light/Appliance Switch.** No more fumbling for switches! Easy to use—keychain remote lets you turn lights and appliances on/off from your driveway. No wiring necessary—just plug in. Controls two modules. Includes one module. **61-2663 24.95**

(2) **Wall-Mount 4-Channel Wireless Switch.** Controls up to four sets of modules (extra). **61-2664 14.95**
More Plug 'n Power items on pages 82-85

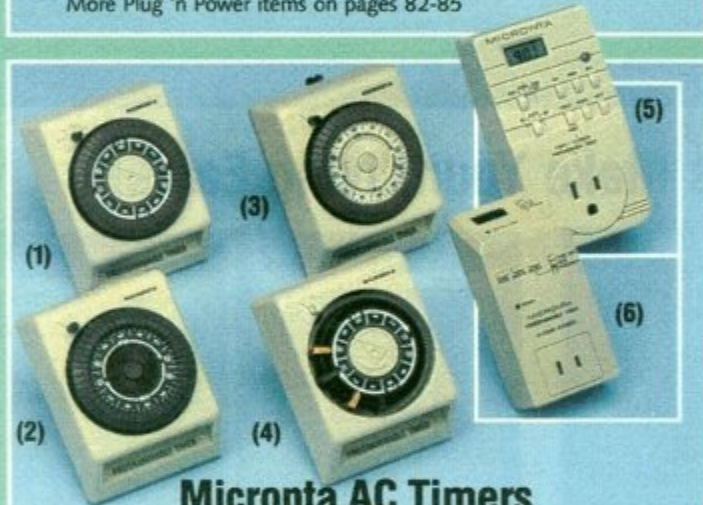

Micronta AC Timers

- (1) **Grounded Heavy-Duty AC Timer.** Ideal for heaters, air conditioners, computers and other high-current plug-in equipment. Two on/off settings per day. **63-866 ... 14.95**
- (2) **Plug-In.** 12 hourly on/off cycles. **63-864 9.95**
- (3) **Tabletop 24-Hour.** 12 on/off settings. **63-685 ... 14.95**
- (4) **Mini Plug-In.** Two on/off settings. **63-862 7.95**
- (5) **7-Day, 14-Event LCD.** Up to seven daily or weekly on/off settings. With memory battery. **63-892 27.95**
- (6) **8-Event LCD.** Four on/four off times daily. Requires "AA" battery for memory backup. **63-891 22.95**



New! Convert Any Lamp Into a 3-Way "Touch Lamp"

Touch Lamp Converter Control. The kit that instantly converts any lamp into a 3-way touch lamp. Increases bulb life by 200% or more, conserves energy, and there's no need to buy expensive 3-way bulbs. Just touch any metal part—even the cord, and controller does the rest. Only responds to human touch—pets can't turn lamps on or off. **61-2771 14.95**

America powers up safely with Archer® and Micronta®



New! Spike Protector for Phone, Fax and AC

Just the thing for offices—why take unnecessary chances? Protect your valuable office equipment and filter out noise on fax lines with this new spike protector. Works for modems, too. Features a circuit breaker with reset button, two modular telephone/fax jacks and six grounded AC outlets. Test button. Rated 15 amps.

61-2788 39.95
Available Nov. 30, 1992



Plug-In 120VAC Voltage Spike Protectors

ALL AT NEW LOW PRICES! REDUCED FROM 1992 CATALOG!

- (1) **Double-Duty TV/VCR Protector.** Protects AC lines and 75-ohm antenna/cable-TV line. Rated 15A. Was \$29.95. **61-2787 27.95**
- (2) **Cordless 6-Outlet.** Breaker, noise filter. 13A. Was \$24.95. **61-2786 .. 21.95**
- (3) **Cordless 3-Outlet.** Status light. Rated 15A. Was \$14.95. **61-2793 ... 12.95**
- (4) **Heavy Duty.** Ideal for microwaves. 15A. Was \$9.95. **61-2792 7.95**
- (5) **Single Outlet.** Status light. Rated 15A. Was \$7.95. **61-2791 6.95**



Power Failure Night-Light

Rechargeable! Extra-bright power failure light turns on if AC fails. Doubles as a flashlight. **61-2772 15.95**



Light Bulb Life Extenders

Extend bulb life up to 300%. Decrease energy consumption with no noticeable decrease in brightness. **61-2726 Pkg. of 2/4.99**

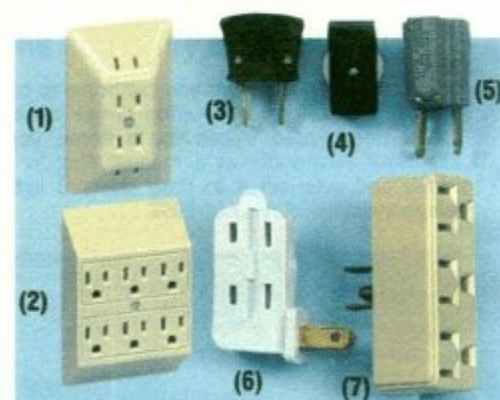

Outlet Adapters, Plugs and Line Switch

- (1) **Four-Outlet.** 2-prong. **61-2621, 2.99**
- (2) **Six-Outlet.** For 3-Prong (grounded) AC outlets. **61-2622 4.39**
- (3) **AC Quick-Plugs.** Replace old plugs in seconds. **61-2702 Pkg. of 2/1.49**
- (4) **Line-Cord On-Off Switch.** Ideal for lamps and small fans. **61-2713 1.49**
- (5) **Grounded Plug Adapters.** Convert 3 prongs to 2. **61-2720 Pkg. of 2/1.29**
- (6) **Three-Outlet Cube Tap.** **61-2714, 1.79**
- (7) **Three-Outlet AC Socket.** Converts one 3-prong outlet to three. **61-2705 ... 2.49**

Momentary high-voltage "spikes" in the AC line can cause expensive damage to TVs, VCRs, stereos and other valuable items. Because spikes occur often, all electronics are in danger. Archer protectors reduce risk by absorbing spikes before they cause damage and have features others leave out: fuse protection, neon indicator and tests for dielectric breakdown. These higher standards mean better protection for you.



New! 3-Way Voltage Spike Protector

Neutralizes harmful power spikes as well as radio and electromagnetic interference to assure you of safe, clean power up to 120V, 15A and 60 Hz. Full 3-line protection—hot, neutral and ground.

61-2794 12.95





(1) (2)

Spike-Protected AC Power Strips

(1) **Automatic Power Controller.** Power-up or turn off entire A/V system by turning one component on and off. Great for use with remote-control VCR, cable box, TV, CD player. Has one sensed, four switched, one unswitched outlets. Built-in spike protector, line-noise filter, circuit breaker. 15A total. (TSP) 61-2781 49.95

(2) **Six Outlets With Built-In Broadband Noise Filter.** Has 0.1 to 100 MHz filter, lighted switch, breaker. 15A total. (TSP) 61-2780 29.95

AC Circuit Testers

New! Identify Circuit Breakers Quick 'n Easy

Save time and legwork—no more guessing or trial-and-error to find out which circuit breaker or fuse is the right one! Just plug transmitter into the outlet you want to trace to the circuit breaker/fuse box, then use receiver to locate the correct circuit or fuse. When the receiver lights up and beeps, you've found the circuit you want! There's no direct electrical connection so you don't have to turn the AC power off. Can be used around sensitive equipment. Transmitter, UL listed AC operation. Receiver requires 9V battery. 61-2721 29.95



(1) (2) (3)

Easy-to-Use AC Circuit and Outlet Testers

(1) **AC Voltage Sensor.** Indicates presence of AC voltages from 70 to 440VAC, without a direct electrical connection. Easy and safe way to check for broken connections, blown fuses, defective grounds, open breakers, and more. With instructions and replaceable battery. 22-103 11.99

(2) **Grounded Outlet Analyzer.** Color-coded neon lamps quickly indicate faults in AC outlets. 22-101 5.99

(3) **Neon Circuit Tester.** 90 to 300 volts AC/DC. 22-102 1.99



(1) (2) (3) (4) (5)

Wireless-Remote AC Power Switch

(1) So easy to connect and use! Just plug receiver module into AC, then plug a TV, stereo, lamp or appliance into module. Turn device on/off with the remote. Rated 15A, 500W incandescent, 400W TV. Remote requires 9V battery. 61-2667 21.95



Auto and Manual Light Controls

(2) **Automatic Outdoor.** On at dusk, off at dawn. For incandescent bulb up to 150W. Fits PAR socket. 61-2775 9.95

(3) **Automatic In/Outdoor.** Fits most lamps and fixtures. Same rating as in figure 2. 61-2776 7.95

(4) **Manual Lighted Toggle Dimmer Switch.** 61-2693 8.95

(5) **Plug-In Automatic Night Light.** Brightens as darkness increases. Shuts off automatically at dawn. 61-2646 4.95

The Best in AC Power Strips — Compare Our Standards

Heavy-gauge metal housings—not plastic, industrial-type square outlets, 6-foot cord with 3-prong plug. **Six-Outlet.** Lighted on/off switch, circuit breaker. Rated 15A. 61-2619 21.95
Four-Outlet. As above with four outlets and without switch. 61-2620 15.95

Dependable Extension Cords and Remote On/Off Switch

Feet	Description	Cat. No.	Each	Feet	Description	Cat. No.	Each
6	White, 3-Outlet	61-2744	1.99	25	Brown, 1-Outlet	61-2759	4.29
6	Brown, 3-Outlet	61-2745	1.99	3	Grounded, 3-Outlet*	61-2764	5.49
9	White, 3-Outlet	61-2746	2.39	10	Grounded, 1-Outlet*	61-2749	4.29
9	Brown, 3-Outlet	61-2747	2.39	10	Grounded, 3-Outlet*	61-2765	6.49
15	Brown, 3-Outlet	61-2748	3.39	9	For Air Conditioner*	61-2758	7.99

Remote AC Power Switch. Lets you turn lamp, TV, stereo or appliance on/off from chair or bed up to 15 feet away. 61-2715, 7.29

*Heavy-duty type

ALL AC-CONNECTED PRODUCTS ON THESE TWO PAGES MEET ELECTRICAL SAFETY STANDARDS SET BY UNDERWRITERS LABORATORIES

America's A freshest batteries are at Radio Shack

Our ENERCELL® batteries are renowned for long-lasting power and long storage life—consistently highly rated in consumer tests. Because we sell over 130 million a year, they're always factory-fresh and powerful when you buy them.

Trust America's Technology Store to supply the fresh, strong batteries you need for virtually any consumer use—flashlights, radios, watches, toys, cordless phones and more.

We're #1 in USA sales of rechargeable batteries. Smart shoppers know that rechargeables are the money-saving choice in the long run. We recommend rechargeables for their environmental "friendliness".

We're your source for special-purpose batteries, too. We stock types for hearing aids, calculators, cameras—you name it. And our special-order service is your "hotline" to hard-to-find types (see page 90). For fresh, strong batteries to meet 'most any need, always shop Radio Shack.





THIS = ALL THESE, AND MORE!

ENERCELL rechargeables save you money! In the headset stereo example below, the cost of standard alkaline batteries would be \$633. The rechargeable batteries, recharger and power cost of 1095 recharges would be about \$26. That's a \$607 savings!

Our ENERCELL Ni-Cds cost much less in the long run and they help cut needless waste dramatically!

In this age of environmental awareness, how do rechargeable batteries stack up against disposable batteries? A study conducted by Carnegie-Mellon University supports the environmental positioning of rechargeable batteries. The study concluded that a portable headset stereo using four batteries and operated two hours a day over a three-year period would have used 876 alkaline batteries. These batteries would add 24,100 grams of trash, including 105 grams of mercury, to the environment. The same stereo headset operated for the same amount of time using nickel-cadmium rechargeable batteries would add only 90 grams of waste to the environment. Obviously, rechargeable batteries significantly reduce the amount of waste that needs to be disposed of.

Ni-Cd batteries and chargers keep your electronic equipment ready to go



Rechargeable Ni-Cd Batteries

ENERCELL batteries recharge to their full strength for just pennies a charge—they actually cost much less in the long run than alkalines!

Size	Volts	Amp Hour	Replacement for			Cat. No.	Price
			Duracell	Eveready	GE		
"D"	1.25	1.600	NC13	CH50	GC3	23-123	Pkg. of 2/6.79
"C"	1.25	1.600	NC14	CH35	GC2	23-124	Pkg. of 2/6.79
9V	7.2	0.065	NC1604	CH22	GC9	23-126	Each/9.95
"AA"	1.25	0.650	NC15	CH15	GC1	23-125	Pkg. of 2/4.69
"AAA"	1.25	0.180	NC24	CH12	...	23-127	Pkg. of 2/5.39
"N"	1.25	0.150	23-121	Pkg. of 2/5.39

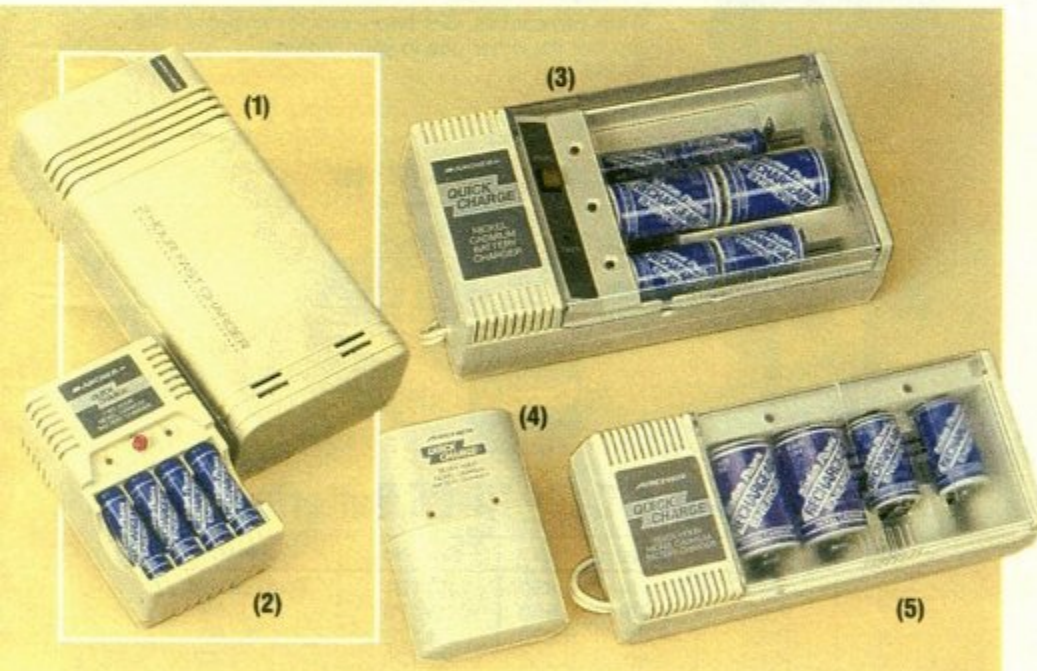

Our Quickest Chargers—Take Only 2 Hours

- (1) **NEW! 2-Hour Universal Ni-Cd Charger.** Always have charged batteries on hand. Recharges "D", "C", "AA", "AAA" sizes in two hours and 9V in 4-5 hours. 23-239 29.95
- (2) **Deluxe "AA" Charger.** Never be without power for your personal radio or other battery-powered electronics. Recharges four commonly used "AA"-size batteries in just a short two hours. 23-234 14.95

Ni-Cd Chargers to Fit Your Needs

- (3) **Quick-Charger.** Recharges "D", "C", "AA", "AAA" and 9V in five hours. Holds six batteries at a time (except 9V). 23-233 26.95
- (4) **NEW! "AA", "AAA" and 9V Quick-Charger.** Charges one or two 9V or two or four "AA"/"AAA" batteries in seven hours. Automatically regulated to prevent overcharging your batteries. 23-236 9.95
- (5) **NEW! 7-Hour Universal Quick Charger.** Fast and cost-efficient. Charges two or four "AA", "AAA", "C", "D" or "N" or one or two 9V at once. 23-237 17.95

HI-CAPACITY™ Nickel-Cadmiums

Heavy-duty rechargeables for high-current-drain equipment such as cordless tools.

Size	Volts	Ampere Hours	Cat. No.	Each
"D"	1.25	4.3	23-140	7.95
"C"	1.25	2.0	23-141	5.95
"AA"	1.25	.85	23-149	5.95



Ni-Cd Chargers

■ Charge batteries overnight

- (1) **Deluxe Charger.** Charges 9V and 10 "D", "C" and "AA" batteries, plus "AAA" and "N" sizes with modules below. 23-134 ... 29.95
- (2) **Standard Charger.** Charges 9V and four "D", "C" and "AA" sizes, plus "AAA" and "N" with modules below. 23-132 12.95
- (3) **Standard "AA".** Holds four. 23-133, 5.95
 "AAA" Module. 23-135 Pkg. of 4/1.95
 "N" Module. 23-137 Pkg. of 4/1.95



Our nickel-cadmium batteries save you money and are kind to the environment

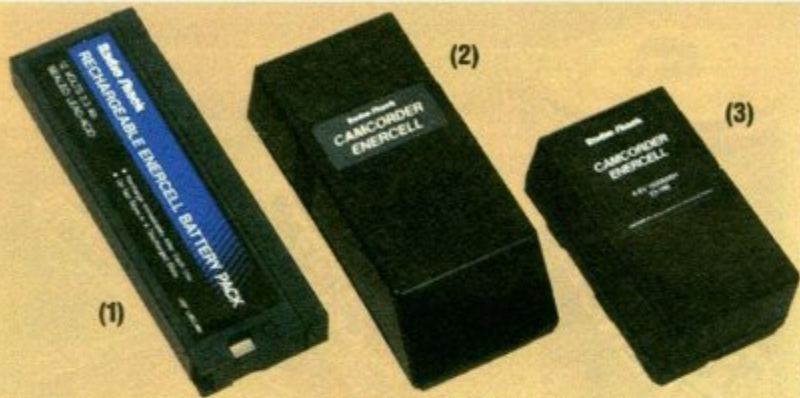

Rechargeables for Phones & Camcorders

- (1) **12-Volt Cellular.** Battery for use with Tandy Cellular Transportable Phone CT-1033 and many video camcorders. 12V, 2300mAh. **23-187** 39.95
Charger. For above. **17-610** (CMC special order) 54.95
- (2) **12V VHS.** For Radio Shack Model 100 MovieCorder and many other popular camcorders. 12V, 1500mAh. **23-183** 39.95
- (3) **9.6V VHS.** For Radio Shack Models 101/125 and many others. 9.6V, 1500mAh. **23-186** 39.95



Low-Priced Cordless Phone Batteries

Why pay more for factory replacements? Come to Radio Shack and get the battery you need today. You'll save money and time.

Fig.	Type	Volts	Ah	Connector	Cat. No.	Each
1	Pack	3.6	.280	B	23-192	6.95
2	Pack	3.6	.650	B	23-193	9.95
3	Pack	3.6	.280	A	23-194	6.95
4	Pack	3.6	.250	Plate	23-172	9.95
5	Pack	3.6	.280	B	23-195	6.95
6	NEW! Pack	3.6	.250	B	23-196	9.95
7	NEW! Pack	3.6	.250	B	23-197	9.95

Connector Plug

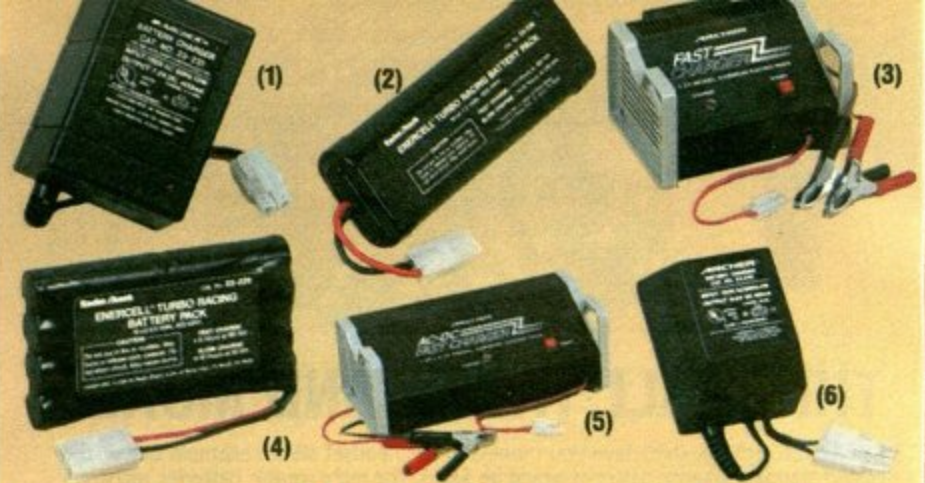

Radio Control Racing Batteries and Chargers

- (1) **NEW! Battery Pack Charger.** Recharges 7.2V Ni-Cd racing pack in 14 hours. For #23-230 below and most other 7.2V battery packs. **23-241** 9.95
- (2) **Rechargeable 7.2V Ni-Cd Battery Pack.** Get the most speed from your radio-controlled vehicles—ultra light weight at a mere 320 grams. **23-230** ... 19.95
- (3) **Portable DC Fast-Charger.** Connects to 12VDC automotive battery. Recharges 7.2V Ni-Cd pack in 20 minutes! LED charging indicator. **23-232** 29.95
- (4) **ENERCELL® 9.6V Ni-Cd Turbo Racing Battery Pack.** Put some zip in your RC equipment! Six-cell short pack rated 9.6 volts at 600mAh. **23-229** 17.95
- (5) **Portable AC/DC Fast-Charger.** Use 120V house current or 12VDC car or truck battery to charge 7.2 or 8.4-volt RC Ni-Cd battery pack. Recharges in 30 minutes or less. **23-235** 69.95
- (6) **NEW! 9.6V Battery-Pack Charger.** Recharges Ni-Cd racing pack in 14 hours. **23-240** 9.95



Battery for 8mm Camcorders

NEW! Top-quality nickel-cadmium pack replaces two rechargeable batteries in the Sony Handycam, Panasonic Palmcorder, and many other popular brands of 8mm camcorders. Get two—one for charging while you use the other one in your camera. **23-215** 24.95



Replace-A-Cell® Ni-Cd Batteries

Fig.	Type	Volts	Ah	Cat. No.	Price
1	"AA"	1.25	0.650	23-191	Pkg. of 2/4.79
2	Pack	3.75	0.500	23-170	8.95
3	Pack	4.80	0.250	23-173	11.95
4	Pack	3.60	0.250	23-176	9.95
5	Pack	3.60	0.280	23-177	5.95
6	Pack	3.60	0.280	23-171	5.95
7	Sub "C"	1.25	1.600	23-190	Pkg. of 2/6.79

Radio Shack "Hotline" to Everything in Batteries

Your nearby Radio Shack store can supply virtually any consumer-type battery currently in production. Our comprehensive selection includes "communications" batteries used in police, fire and emergency walkie-talkies, special batteries for cordless phones, computer memory, camcorders, pagers, medical equipment, camera flash units, and many more. Whatever you need in a battery, we can get it for you. We place your order on our "hotline" and your batteries are rushed directly to your Radio Shack store from our special warehouse. We notify you the same day they arrive. No extra charge for this service!





Special-purpose ENERCELL® batteries for lasting power at prices you'll like

ENERCELL Photo and Special-Purpose Batteries

We stock many of those hard-to-find batteries required for cameras, computers, automated systems and all sorts of electronic equipment.

Fig.	ENERCELL	Replacement for			Cat. No.	Each
		Duracell	Eveready	Panasonic		
1	BRP2	BPR2	23-175	12.95
2	DL123	DL123	...	CR123	23-155	7.95
3	2CR5	DL245	EL2CR5BP	2CR5	23-178	12.95
4	DL223	DL223	EL223ABP	CRP2	23-179	12.95
5	7K67	7K67	539	...	23-471	3.99

Watch and Calculator Lithium Batteries

ENER CELL	Replacement for			Cat. No.	Each
	Duracell	Eveready	Ray-O-Vac		
CR2016H	DL2016	ECR2016	BR2016	23-160	1.99
CR2025	DL2025	ECR2025	BR2025	23-161	1.99
CR2032	DL2032	ECR2032	BR2032	23-162	1.99
CR2430	DL2430	23-166	1.99
CR1616	...	ECR1616	...	23-167	1.99
BR2325	23-168	1.99
CR1220	23-188	1.99

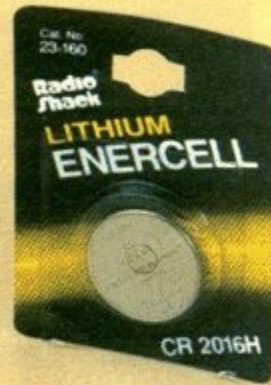

Premium-Quality ENERCELL Watch and Calculator Batteries

Specially formulated to keep working longer and harder than "regular" batteries, these ENERCELL batteries are custom-engineered for electronics applications.



Hearing Aid Batteries

Long-Life 1.45V Air-Activated Packs

ENER CELL	Replacement for			Cat. No.	Pkg. of 3
	Duracell	Eveready	Ray-O-Vac		
675HPX	DA675	AC675E	R675ZA	23-157	2.39
13HPX	DA13	AC13E	R13ZA	23-158	2.39
12HP	DA312	AC312E	R312ZA	23-159	2.39
230HPX	230HPX	AC230E	R10Z	23-156	2.39

High-Energy 1.4 Mercury-Powered Packs

ENER CELL	Replacement for			Cat. No.	Pkg. of 6
	Duracell	Eveready	Ray-O-Vac		
P675M	EP675	EP675	MP675H	23-145	2.79
13M	E13E	R13	RM13	23-146	2.79
312M	E312E	T312	RM312H	23-148	2.79



Heavy-Duty Alkalines for Calculators and Games

ENER CELL	Replaces			Cat. No.	Each
	Duracell	Eveready	Maxwell		
357A	...	A76	LR44	23-115	1.39
386A	D186AB	186	LR43	23-116	1.39
389A	D189AB	189	LR1130	23-117	1.39
391A	D191AB	191	LR1120	23-118	1.39



Come to Radio Shack for Hard-to-Find Batteries

We stock an immense number of batteries of all kinds including many special-use types you won't find at other stores. Since we sell so many, our batteries are always fresh and strong. No matter what you're looking for in a battery, the best place to find it is at your nearby Radio Shack.

Fig.	Volts	Replacement for			Cat. No.	Each
		Dura cell	Ever eady	Ray-O Vac		
1	12.0	M926	732	926	23-007	11.95
2	12.6	304116	304116	...	23-670	13.99
3	6.0	Rechargeable, 2.5 Ah	23-181	10.95
4	1.4	RM640	E640	T640-1	23-1515	2.79
5	1.35	RM625	EPX625	T625N	23-462	2.39
6	1.45	DA675	AC675	R675ZA	23-150	2/1.69

Fig.	Volts	Replacement for			Cat. No.	Each
		Dura cell	Ever eady	Ray-O Vac		
7	5.6	PX32B	E164	...	23-463	6.95
8	22.5	M505	505	221	23-510	5.59
9	7.0	TR175B	E175	T175	23-601	5.89
10	1.4	MP401B	E401	T401	23-660	2.99
11	12.0	23-144	1.39
12	6.0	PX28L	A544	RPX28	23-469	3.99
13	1.4	DA-630	23-1501	4/5.49



ENERCELL® - get charged up about America's best battery value!

Why Pay More? Our Famous ENERCELL Brand is Your Best Value in Batteries! We design every ENERCELL to give you long life at a low price. No fancy tops, no costly television commercials. Instead, ENERCELL gives you more value! And, since we sell so many, so quickly (over 130 million a year), you can be sure that every ENERCELL is fresh when you buy it. Consistently top-rated, it's the only brand we know of you can try for FREE! See Battery Card offer below.

Buy 3 or More Packages or 3 9V Premium Super-Alkalines With Same Cat. No. and SAVE 10%
23-550/551/553/552/555/023 Only



Premium ENERCELL Super-Alkaline Batteries

Keep equipment working harder and longer with ENERCELL alkalines! High output at low temperatures and a long shelf life are just a few of the advantages you'll receive from these batteries—compare today!

ENERCELL	Replacement for			Cat. No.	Price
	Duracell	Eveready	Ray-O-Vac		
"D"	MIN1300	E95	813	23-550	Pkg. of 2/2.59
"C"	MIN1400	E93	814	23-551	Pkg. of 2/2.59
9V Rectangular	MIN1604	522	A-1604	23-553	Each 1.89
"AA"	MIN1500	E91	815	23-552	Pkg. of 4/2.89
"AAA"	MIN2400	E92	824	23-555	Pkg. of 2/1.59
"N"	MIN9100	E90	81C	23-023	Pkg. of 2/1.59



ENERCELL Extra-Life, Heavy-Duty Batteries

You'll benefit from the special electrolyte core that gives longer service life, plus up to three years storage life. You'll appreciate the "Miracle-Seal" leak protection, too.

ENERCELL	Replacement for		Cat. No.	Each
	Eveready	Ray-O-Vac		
"D"	1250	6D	23-580	.59
6V Lantern	1209	944	23-016	3.99
9V Rectangular	1222	D1604	23-583	.99
"C"	1235	4C	23-581	.59
"N"	...	810	23-585	.35
"AAA"	912	400	23-584	.39
"AA"	1215	5AA	23-582	.39



Super-Value ENERCELL General-Purpose Standard Batteries

Because we sell so many, so quickly, they are always fresh when you buy them. Compare our quality and prices!

ENERCELL	Replacement for		Cat. No.	Each
	Eveready	Ray-O-Vac		
"D"	950	13	23-466	.37
6V Lant.	509	941	23-006	2.99
9V Rect.	216	1604	23-464	.59
"C"	935	14	23-467	.37
"AA"	915	15	23-468	.29



Battery Checker

Instantly know the true condition of your batteries. This meter shows you when it's time to replace "D", "C", "AA", "AAA", "N" and 9V rectangular batteries. Tests standard, alkaline, mercury and charged Ni-Cds. 22-096 6.99



FREE Battery Club Card!

Join our Battery-A-Month Club and receive one General-Purpose "D", "C", "AA" or 9V ENERCELL each month for a year. FREE! Up to \$7.08 Value! At participating Radio Shack stores and dealers. 6V lantern battery excluded.



New! Car/Home Rechargeable

ENERLITE Deluxe. Just plug directly into AC wall socket to charge. When you need it, it's always charged and ready. In the car, just plug its 12VDC adapter into cigarette lighter receptacle. Up to two hours of light per charge. Includes built-in charger, Ni-Cd batteries, retractable AC prongs and 12VDC converter plug. **61-2546 27.95**



Rechargeables for the Home

(1) **ENERLITE Safety Lantern/Flashlight.** Plugs directly into AC and comes on when AC fails. Swivel head. Two hour charge. Built-in charger and Ni-Cd batteries. **61-2741 21.95**
 (2) **ENERLITE Handheld.** Compact—plugs directly into AC, comes on during AC failures. Built-in charger, Ni-Cd batteries, retractable plug. **61-2545 14.95**

Flashlights and lanterns for every need

Radio Shack has a huge selection of top-quality, reliable flashlights for camping, working, travel or emergencies—come in and see!



New! Handsfree Flashlight

ENERLITE Magnetic. Three powerful magnets on the base make it extremely versatile. Mounts under hood of car to give you additional light at night, or remove from base and use as a standard light. Requires 2 "C" batteries. **61-2517 .. 11.95**



Halogen Searchlight

ENERLITE Hi-Power. Just plug directly into car cigarette lighter with included cord, and you have a powerful halogen searchlight that cuts through darkness. Perfect for people who work outdoors. With 12VDC cord. **61-2505 29.95**



New! Safety Strobe

ENERLITE Personal Strobe. Perfect for joggers and walkers as well as road emergencies—high-visibility blinking Xenon flash. Magnetic base, strap for wrist or arm and belt hook. Requires "C" battery. **61-2506 19.95**

ENERLITE—The Best! You're Always Bright When You Buy Flashlights at Radio Shack

Fig.	Description	Batteries Required	Cat. No.	Each
1	Krypton Heavy-Duty All-Metal Pocket Penlight	3 "D"	61-2537	24.95
2	"D" Cell with Krypton Bulb	2 "AAAA" Included*	61-2538	14.95
3	Adjustable-Focus Safety Type Lantern with Krypton Bulb	2 "D"	61-2540	5.29
4	Penlite with Krypton Bulb	3 "D"	61-2541	6.29
5	Flasher with Krypton Bulb	2 "AAA"	61-2536	8.99
6	Rugged Halogen Lantern	4 "AA"	61-2535	7.99
7		4 "D"	61-2525	9.99

Archer Fluorescent Lamps

(8) **3-in-1.** Fluorescent reading lamp, flashlight, warning blinker. With 12VDC cord. Requires 4 "D" cells for battery operation. **61-2739 14.95**

(9) **Mini 2-in-1.** Fluorescent reading lamp and flashlight. Requires 3 "C" batteries. **61-2734 7.95**

*Extra batteries available on special order through our CMC system.



These Radio Shack® and Archer® Flashlights Are Your Best Buys on a Budget

Fig.	Description	Batteries	Cat. No.	Each
1	Safety Wand Flashlight	2 "D"	61-2516	3.49
2	Halogen-Bulb Flashlight	2 "D" Included	61-2737	12.88
3	Heavy-Duty "D" Cell	2 "D"	61-2639	2.39
4	Heavy-Duty "C" Cell	2 "C"	61-2641	2.39
5	Aluminum Pocket Krypton Adjustable Focus	2 "AA"	61-2736	9.95
6	Disposable Clip Light	Built-In	61-2625	1.99
7	Pocket Penlight	2 "AA"	61-2626	2.49
8	Hands-Free Headlight	2 "AA"	61-2510	4.49
9	Lantern with Krypton Bulb	6V Lantern	61-2521	5.99
9	Four-Cell Worklight	4 "C"	68-1040	1.98



Radio Shack... the widest choice of power adapters

We have more power adapters for more uses than anyone. Period. Our fast, convenient service will help you find just the right adapter—AC, DC, high-current and others—for your particular equipment. Satisfaction guaranteed. When it comes to taking care of your power needs, come to Radio Shack. Nobody compares—nobody even comes close!

(1) Universal AC-to-DC Adapter. Save batteries! Plugs into AC outlet to operate battery-powered portables having a DC jack. Selectable 3, 4.5, 6, 7.5, 9VDC output. With six Adaptaplugs—connects to almost any DC input jack. UL listed. **273-1650 12.95**

Six-Piece Adaptaplug® Set. 274-1501 . . . 7.29

(2) Universal DC-to-DC adapter. Selectable 3, 4.5, 6, 7.5, 9VDC output. With six Adaptaplugs. **270-1560 12.95**

(3) Hi-Current DC Adapter. Outputs for 6, 9, 12VDC. With four Adaptaplugs. **270-1562 15.95**

Video Game DC Adapters.

Universal. 270-1504 19.95

Nintendo. 270-1505 15.95

Gameboy. 270-1506 9.95

Right-Angle 6-Plug Set. Set of coaxial-type power plugs. Fit fig. 3. **270-1563 7.29**

(4) 9VDC Adapter. Rated 500 mA output. With two Adaptaplugs. **273-1651 10.95**

12VDC Adapter. Rated 500 mA output. Includes four Adaptaplugs. **273-1652 . . . 10.95**

(5) Personal Portable Adapter. Hum-free circuit designed for personal stereos. Selectable 1.5 or 3VDC output. Delivers up to 300 mA. With two Adaptaplugs. **273-1654 13.95**

(6) High-Current 12VDC Adapter. Delivers up to one amp power. Includes three Adaptaplugs. **273-1653 20.95**

(7) AC Adapters for Radio Shack Equipment. All have a body similar to the adapter pictured at right and plug into an AC outlet.

Output		Connector	Cat. No.	Each
VDC	mA			
9	300	Coax Plug	273-1455	7.95
6	150	Coax Plug	273-1454	7.95
9	25	3/32" Plug	273-1431	6.95
3*	200	Coax Plug	273-1456	6.95
3	200	3/32" Plug	273-1435	6.95

*For use with most STEREO-MATE® portables.

(8) Car/Boat DC-to-DC Adapter. Plugs directly into lighter socket. 6 or 9VDC for powering many portable electronic devices. 12VDC neg. ground. **14-844 6.99**

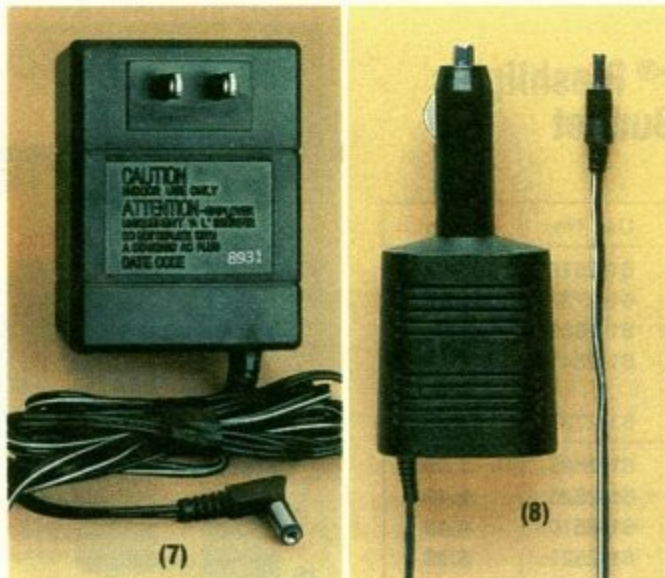
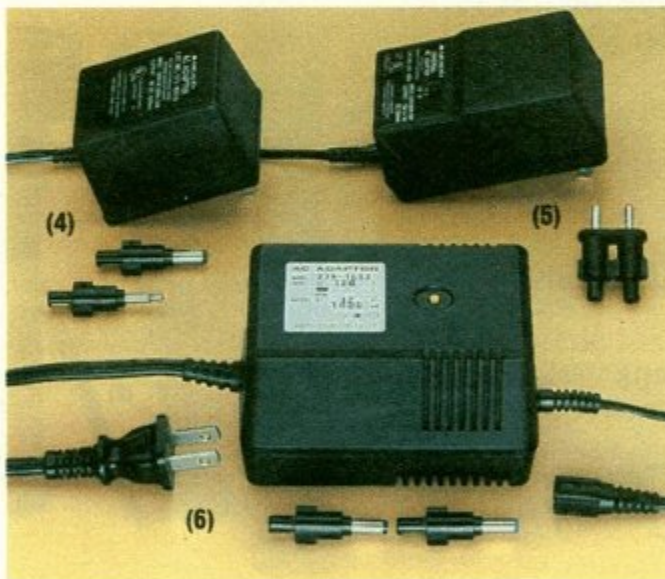

(9) 5-Ft. DC Extension Cable. Fits most AC adapters. Coaxial jack at one end, coaxial plug at plug at the other. Popular 5.5mm O.D., 2.1mm I.D. connector size. **273-1648 3.99**

(10) DC Power Y-Cable. Lets you power two devices with one adapter. **273-1649 4.99**

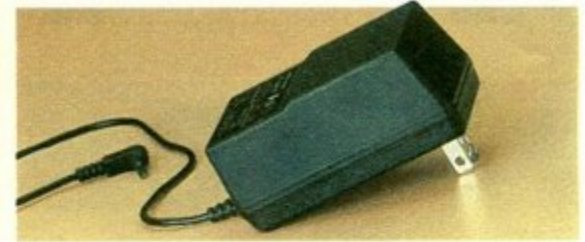

NEW! 3VDC, 600 mA CD Player Adapter. For operating most portable CD players from 120VAC. 3VDC regulated output. UL listed. **273-1659, 16.95**

6/7.5VDC, 700 mA Output. For many LCD TVs, portable CDs, handheld computers. With two Adaptaplugs. UL listed. **273-1655 16.95**

9VDC, 800 mA Output. For musical keyboards, CDs, video games. 5.5mm O.D., 2.1mm I.D. coax plug. UL listed. **273-1656 12.95**



13VAC, 800mA Output. AC-to-AC adapter for phone answerers. With 5.5mm O.D., 2.1mm I.D. coax plug. UL listed. **273-1610 8.95**

9VAC, 1.3A AC-to-AC. For Nintendo™ video game. with 5.5mm O.D., 2.1mm I.D. coax plug. UL listed. **273-1611 15.95**



NEW! AC Adapter for Nintendo Gameboy™. Pays for itself after just a few uses by saving you batteries! Designed by Radio Shack specifically to power the Nintendo Gameboy handheld video game. Plugs into standard 120VAC electrical outlet. 6VDC, 100 mA output. With 3.5mm O.D., 1.4mm I.D. coax plug. UL listed AC. **273-1660 7.99**

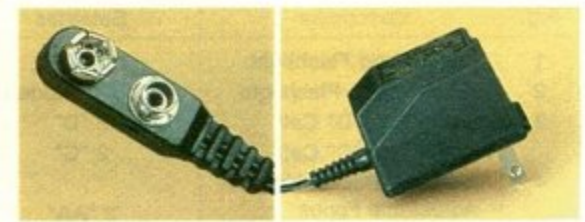

9V Battery Eliminator. Allows you to operate your portable transistor radio from a standard 120VAC electrical wall outlet. Saves batteries. Connector is a snap-type as on 9V rectangular batteries. UL listed AC. **273-1552 6.95**

Power converters to run equipment on foreign AC, plus line testers & plug adapters

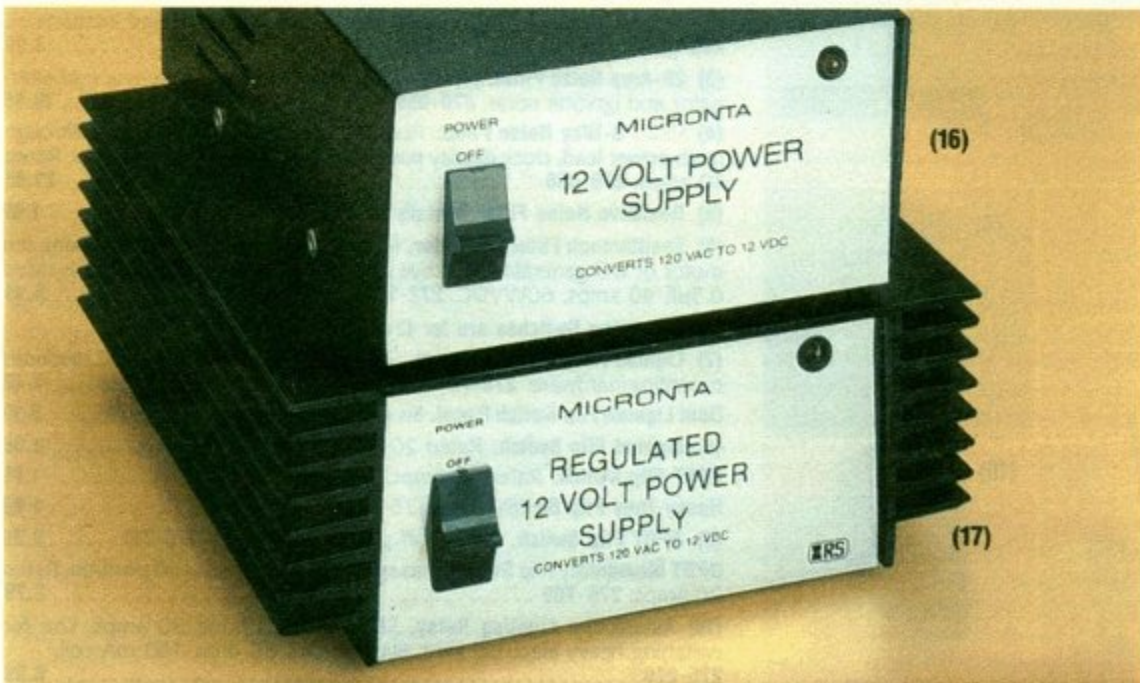
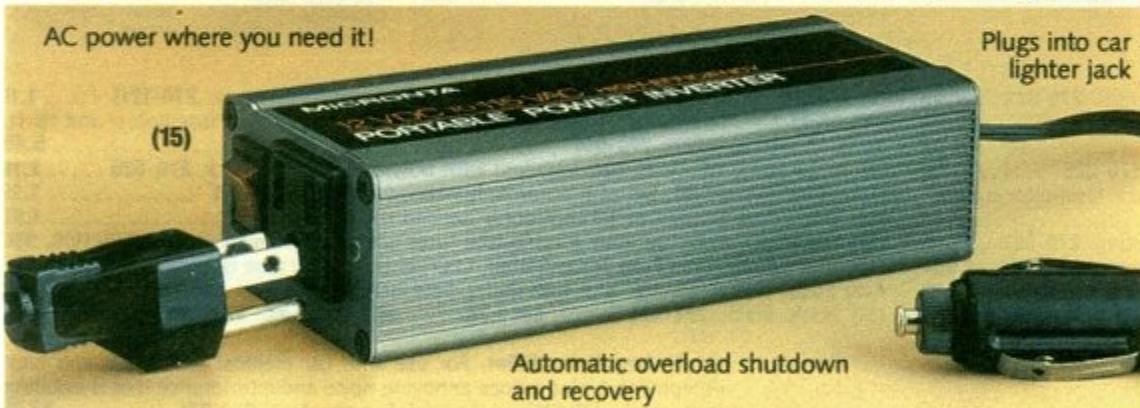
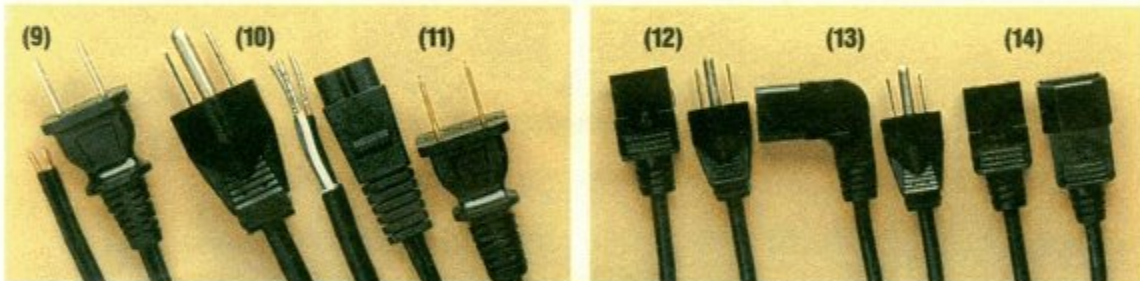
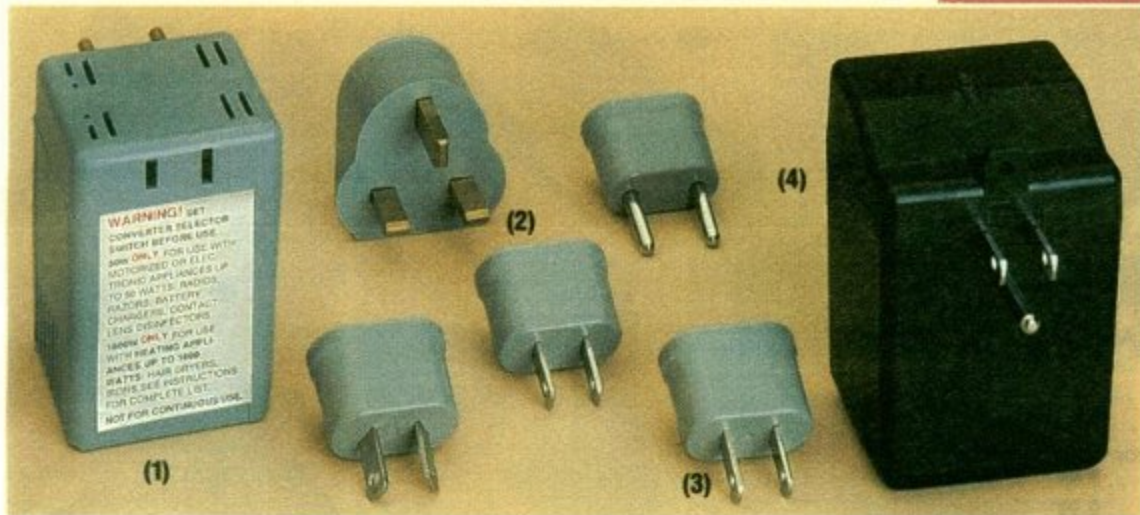

(1) Dual-Wattage Converter. For use with foreign 240VAC power. Operates most 120VAC electronic and motorized appliances rated up to 50 watts, heating-type appliances rated up to 1600 watts. Use with recorders, radios, battery chargers, calculators, irons, handheld hair dryers, curling irons, bottle warmers, lens sterilizers, immersion heaters. 12½ oz. **273-1410** **33.95**

1600-Watt Converter. Lets you operate most 120VAC heating-type appliances from 240VAC. For handheld hair dryers with universal (AC/DC) motors, irons, electric blankets, immersion heaters, incandescent lamps, bottle warmers. 3 oz. **273-1404** **19.95**

1000-Watt Converter. Same use as 273-1404, but with 1000-watt maximum. 3 oz. **273-1402** **16.95**

50-Watt Converter/Transformer for Electronic Equipment. Converts 240VAC to 120VAC to operate most small recorders, radios, photoflashes, chargers, calculators. 9½ oz. **273-1401** **15.95**

(2) Plug Adapters. Connect the converters listed above to almost any outlet, including recessed types. Must be used with a converter. **273-1405** **Set of 4/7.95**

(3) U.S.-Outlet Plug Adapter. Connects dual-voltage appliances with European-style plugs to U.S.-type 120VAC power outlet. **273-1406** **1.95**

(4) NEW! 40-Watt Foreign Reverse Converter. Converts U.S. power supplies (110/120VAC) to foreign standard (220/240VAC). Use with motorized, electronic or heating appliances rated to 40 watts maximum. UL listed. **273-1411** **27.95**

IMPORTANT NOTE! The converters listed above can NOT be used with clocks, TV sets, high-fidelity equipment, typewriters, desktop computers, hooded hair dryers, slide projectors or permanently installed equipment. NOT for continuous use. Will NOT work with DC (direct current). The 1600-watt and 1000-watt converters should NOT be used with transformer-operated equipment.

(5) AC Voltage Sensor. Indicates presence of AC voltages from 70 to 440VAC without direct electrical connection. Easy and safe way to check for broken connections, blown fuses, defective grounds, more. With instructions and battery. **22-103** **11.99**

(6) AC Outlet Analyzer. Simply plug into any 3-wire 110VAC wall outlet to check for a variety of wiring faults which could be dangerous if not corrected. **22-101** **5.99**

(7) Neon Circuit Tester. 90 to 300 volts AC/DC. **22-102** ... **1.99**

(8) NEW! AC Line Voltage Monitor. Color-coded meter shows safe voltage range. UL listed. **22-104** **12.99**

(9) Six-Foot Replacement AC Cord. Two prong. **278-1255** ... **1.19**

(10) Six-Foot Replacement AC Cord. Three prong. **278-1258**, **2.99**

(11) Six-Foot Recorder/Radio Cord. Two-prong AC plug. Other end fits many portable cassette recorders and radios. **278-1254**, **2.49**

Recorder/Radio Cord. Similar to fig. 11. **278-1256** **1.99**

(12) NEW! Shielded Computer Cord. Six feet. **278-1262** ... **4.99**

Six-Foot CEE Cord. For computers. **278-1257** **3.99**

12-Foot CEE Cord. **278-1261** **5.99**

(13) 6-Foot Cord With Right-Angle CEE Connector. For tight spaces. **278-1260** **5.99**

(14) Six-Foot CEE Extension. **278-1259** **4.99**

(15) NEW! 12VDC-to-115VAC Power Inverter. Just the thing for camping trips, tailgate parties and emergencies—no need to haul around bulky generators! Converts 12VDC power to 115VAC—use AC-powered products anywhere! Just plug into your car's lighter jack for AC power on the go. Run small appliances, shavers, electric blankets, TVs, VCRs, battery chargers, camcorders and more. 140 watts continuous output. **22-132** **99.99**

(16) 120VAC-to-12VDC Unregulated Power Supply. Same function as below, but has a nonregulated output and is rated 1.75 amps continuous. UL listed. **22-127** **26.99**

(17) 120VAC-to-12VDC Regulated Power Supply. Ideal for powering most mobile CBs, car stereos, radios and other 12VDC car accessories from AC. Useful in troubleshooting as well as powering electronics and science projects. Features push-to-reset circuit breaker, on/off switch, LED "on" indicator, massive heat sink for cool operation. Rated 2.5 amps continuous. UL listed. **22-120** **39.99**

Hookup helpers for car stereos, CBs and other accessories

- (1) **Heavy-Duty 12VDC Power Plug.** Plugs into vehicle lighter socket. Accepts standard 1/4" x 1/4" -diameter glass fuse up to 7.5 amps. 274-335 2.19
- (2) **12VDC Lighter Plug.** Rated 6 amps. 274-331 1.59
- (3) **Ten-Foot 12VDC Extension Cord.** Rated 6 amps. 270-1536 5.99
- (4) **12VDC Accessory Outlet.** Mounts underdash or in camper for powering 12VDC devices such as car phone or radar detector. 270-1539 5.99
- (5) **Triple 12VDC Accessory Outlet.** Rated 15 amps, total. 270-1544 9.99
- (6) **Auto Electrical System Tester.** Just plug into lighter socket. Color-coded LEDs help you spot battery and charging system problems before you're stranded. 12VDC negative ground. 22-1635 5.95
- (7) **Universal 12VDC Fused, Coiled Cord.** Tangle-resistant. Four coax-style plugs fit a variety of 12VDC devices. Replaceable 2-amp fuse. 270-1528 9.95
- (8) **Heavy-Duty 12VDC Fused Cord.** 6-ft. 3-amp fuse. Coax plug. 270-1534 5.99
- (9) **Two-Outlet 12VDC Y-Adapter.** Power two 12VDC devices from one lighter outlet. Rated 8 amps. 270-1535 5.99
- (10) **Standard 12VDC Fused Cord.** 8-ft. 2-amp fuse. Coax plug. 270-1533 3.99
- (11) **NEW! 12VDC Cord With Battery Clips.** Attach directly to 12-volt battery to power 12VDC devices such as vacuum cleaners and trouble lights that have a lighter-style plug. 270-1527 5.99
- (12) **12VDC Lighter Plug.** With 8-ft. cord. 270-021 3.29

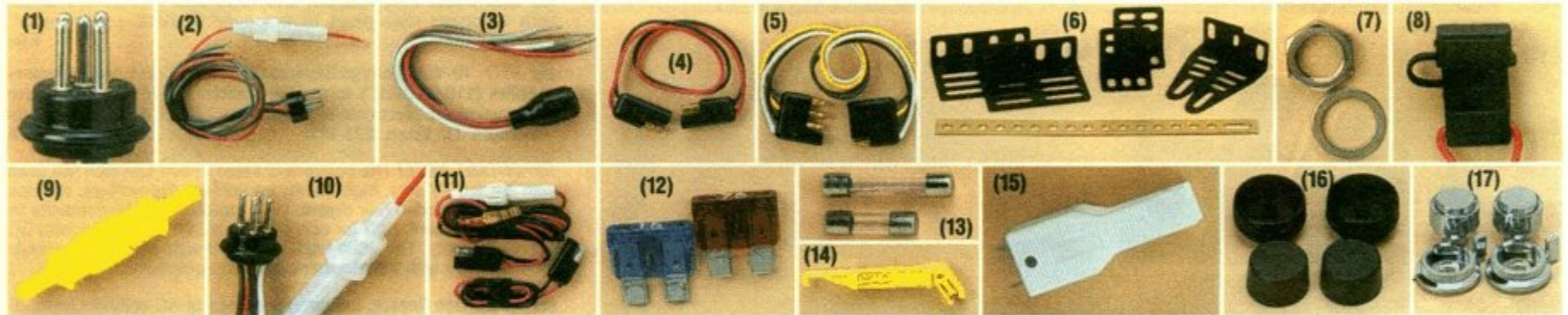
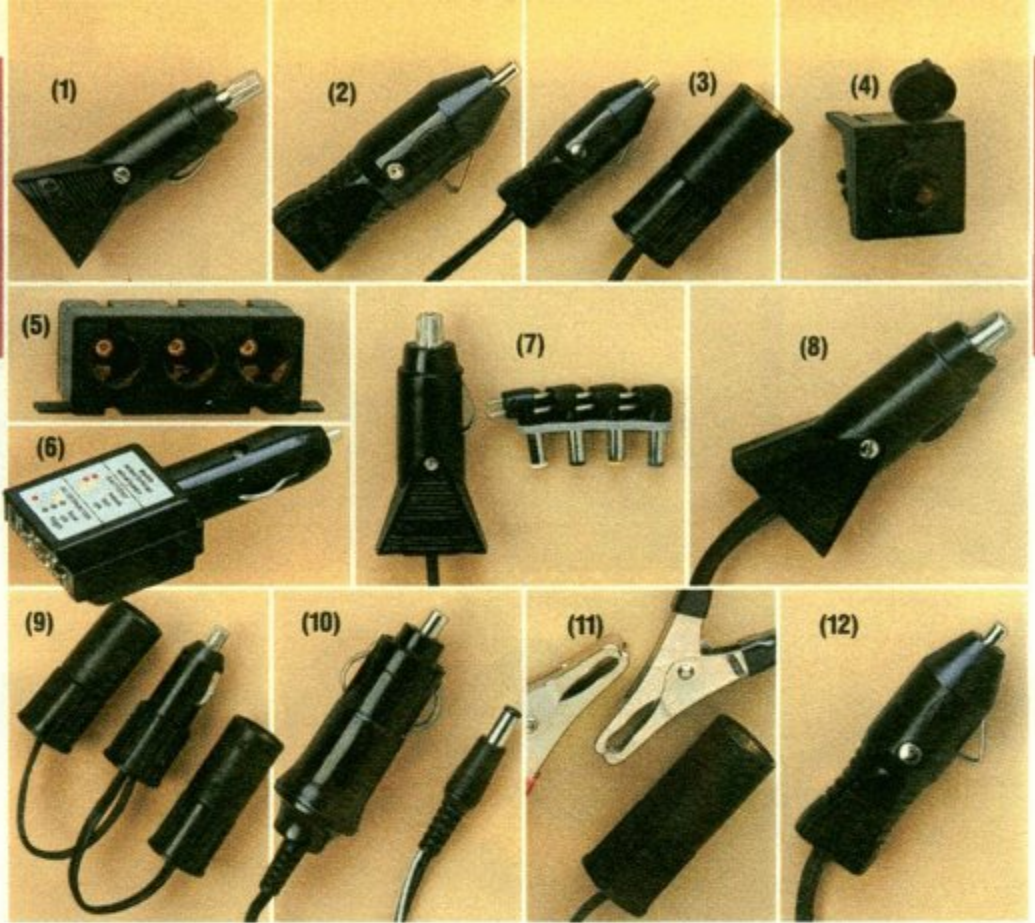

- (1) **5-Pin Car Stereo Plug.** 12" leads. Fits Realistic®/Optimus® car stereos. 270-041 ... 2.49
- (2) **Universal Car Stereo Plug.** Fits 4 or 5-pin sockets. 12" leads. 270-017 2.29
- (3) **5-Pin Inline Car Stereo Socket.** 7" leads. 274-1215 1.59
- (4) **2-Conductor Accessory Cable.** 12" long. Polarized plug and jack. 270-026 1.19
- (5) **4-Conductor Accessory Cable.** 12" long. With polarized plug and jack. Useful for connecting trailer lights and other accessories. 270-027 2.19
- (6) **Universal Mounting Bracket Set.** Three pairs of brackets, support strap. 270-023 .. 3.49
- (7) **Control Shaft Nuts and Washers.** 6 each. For Korean-made car stereos. 270-024 .. 99¢
- NEW! Control Shaft Nuts and Washers.** 6 each. For Hong Kong car stereos. 270-028... 1.19
- (8) **Inline "Blade" Fuse Holder.** For fuse up to 30 amps. 270-1213 1.79

- (9) **Inline Fuse Holder for Glass Fuse.** Rated for fuse up to 20 amps. 270-1211 1.19
- (10) **18-Ft. Car Stereo Cable Assembly.** Includes prewired 5-pin plug, fuse holder and 18-ft. leads for two speakers. 270-014 5.49
- (11) **4-Ft. Fused DC Cable Set.** Prewired with polarized plug and jack. 270-025 2.19
- (12) **"Blade" Fuse Kit.** Set of 5 commonly needed ratings. 270-1201 1.99
- (13) **Glass Fuse Kit.** Set of 10 commonly needed ratings. 270-1262 1.99
- (14) **Fuse Tool.** Install/remove glass/plastic fuses without damaging them. 270-1199, 99¢
- (15) **NEW! Blade-Type Fuse Tester/Puller.** LED lights to show fuse is good. 270-1198, 4.99
- Auto Sound Knobs.** Fit "D" and split shafts. Sets include two inner and two outer knobs.
- (16) **Matte-Black.** 274-425 Set 1.79
- (17) **Chromed.** 274-427 Set 2.99

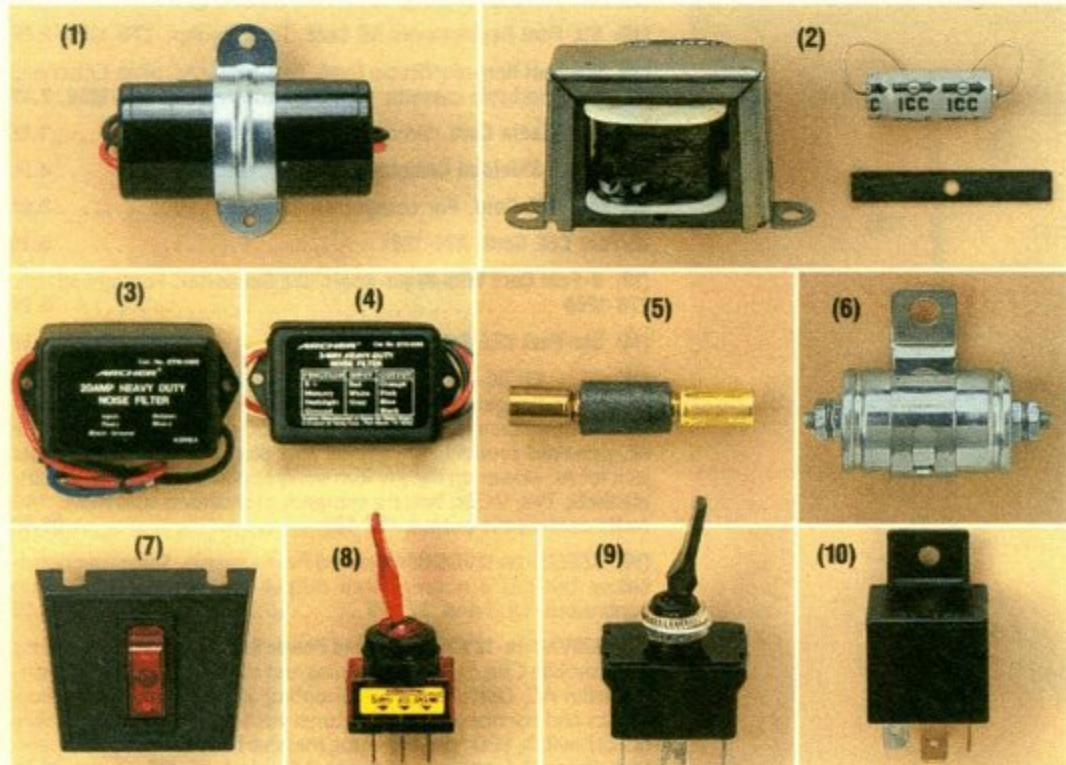

- (1) **10-Amp Noise Filter.** For use with car stereos, radios, CB and ham equipment. Helps reduce annoying noise and interference that is entering through the 12VDC power lead. Easy hookup. 270-051 13.95
 - (2) **Noise Eliminator Kit.** Includes filter choke, capacitor and instructions. 270-030 3.99
 - (3) **20-Amp Noise Filter.** Heavy-duty design for extra suppression of alternator and ignition noise. 270-055 18.95
 - (4) **NEW! 3-Way Noise Filter.** Reduces noise entering car stereo through main power lead, clock display power lead and memory power lead. Rated 10 amps. 270-056 21.95
 - (5) **Resistive Noise Filter.** Installs at distributor cap. 270-012 1.99
 - (6) **Feedthrough Filter Capacitor.** Helps cut noise from ignition system, fan motor or DC generator. Effective and simple to install. Capacitor is rated 0.5µF, 40 amps, 60WVDC. 272-1085 5.99
- The Following Switches are for 12-Volt DC Use**
- (7) **Lighted Rocker Switch Panel.** SPST. Rated 20 amps at 12VDC. Includes mounting hardware. 275-704 4.49
 - Dual Lighted Flip Switch Panel.** Switches rated 20A each. 275-702 ... 3.19
 - (8) **Lighted Flip Switch.** Rated 20 amps. 275-706 2.59
 - SPST Flip Switch.** Rated 16 amps. 275-701 1.99
 - Heavy-Duty Flip Switch.** Rated 25 amps. 275-708 1.99
 - (9) **DPDT Flip Switch.** Center off position. 20 amps. 275-710 2.39
 - DPDT Momentary Flip Switch.** Has spring return to center off position. Rated 20 amps. 276-709 2.79
 - (10) **Automotive Lighting Relay.** SPST contacts rated 30 amps. Use for switching heavy electrical load. Has 12VDC, 66-ohm, 160 mA coil. 275-226 5.99

Do it by the book! Boost your knowledge of electronics technology

General Interest

Recording Great Audio. Learn how to record, amplify, mix and copy audio signals while maintaining high fidelity. 140 pages. **62-1089** **4.95**

Building Speaker Systems. A detailed description of speakers. Includes plans and parts lists for building four speakers. 128 pages. **62-1087** **5.95**

Home/Auto Security Guide. How to select and install effective anti-theft devices for your home or car. 119 pages. **62-1086** **5.95**

Using Your Meter. Get the most from your VOM or digital multimeter. Includes test hookups and procedures for all types of electronic circuits as well as household appliances and car electrical systems. 128 pages. **62-2039** ... **4.95**

Antennas—Selection and Installation. Here's everything you need to know to choose and install the best possible antenna system. 112 pages. **62-1083**, **3.95**

Electronic Life-Style. An exciting look at how new electronic products are changing our lives. 160 pages. **62-2340**, **9.95**

ENERCELL® Battery Guidebook. Explains how batteries work and describes the different types. You'll learn how to select the best batteries for different jobs. 232 pages. **62-1304** **5.95**

Semiconductor Reference Guide. The latest edition of our famous "sub" guide. Provides cross reference and substitution listing for over 95,000 semiconductor types. Also provides detailed data on Radio Shack ICs, SCRs, diodes, LEDs and modules. **276-4015** ... **3.99**

Getting Started in Electronics. By Forrest Mims, III. A super "hands on" introduction to building electronic circuits. Features large diagrams and easy-to-read text by one of America's most popular science writers. 128 pages. **276-5003** **2.99**

Building Power Supplies. Explains how switching and linear-type supplies operate. Covers regulated and unregulated designs. You get easy-to-follow plans for building five useful power supplies with Radio Shack parts. **276-5025**, **4.95**

Computer Science

NEW! A Kid's Guide to Computers. For ages eight and up. The ultimate collection of computer facts—and fun! Puzzles, activities and more. **25-1474**, **12.95**

Upgrading to DOS 5.0. Offers expert tips and techniques to acquaint users with the features of DOS 5. **25-1439** . . . **14.95**

Engineer's Mini-Notebooks

By Forrest Mims, III. Building and testing your own circuits is the fun way to learn about electronics. Notebooks in this series feature the friendly style made famous by Mims—big diagrams, concise text plus valuable safety tips and suggestions for further experiments.

Science Projects. Build interesting projects using ordinary household materials and Radio Shack parts. Shows you how to construct your own simple batteries, a super capacitor, light and moisture sensors, wind speed indicator, even a simple ground-motion "earthquake" detector. 48 pages. **276-5018** **1.49**

Timer ICs. Covers the popular 555 and 556 types. 32 pages. **276-5010** .. **99¢**

Op Amps. Learn how to use the versatile devices. 48 pages. **276-5011** **1.49**

Optoelectronics. Projects ranging from LED circuits to lightwave communication systems. 48 pages. **276-5012**, **1.49**

Basic Semiconductor Circuits. Learn to use bipolar transistors, FETs, LEDs and more. 48 pages. **276-5013** **1.49**

Digital Logic Circuits. Handy data on the use of gates, TTL and CMOS devices. 48 pages. **276-5014** **1.49**

Communications Projects. Includes light communication projects, telegraphs and simple radios. 48 pages. **276-5015**, **1.49**

Formulas, Tables, Basic Circuits. Understand Ohm's law and many other "basics". 48 pages. **276-4016** **1.49**

Schematic Symbols. With handy troubleshooting tips. **276-5017** **1.49**

Amateur Radio

Amateur Radio Study Guides. Enter this exciting hobby or upgrade to a higher class license and privileges.

No-Code Technician-Class Study Manual. A guide for the new Technician-class license which does not require a Morse code exam. **62-2413** **9.95**

Now You're Talking. Study guide for the Novice and Technician-class licenses plus an intro to ham radio. **62-2414** **16.95**

Novice-Class License Preparation. Study manual with test questions and answers, plus two code cassettes. **62-2410**, **19.95**

Technician-Class Manual. **62-2411**, **4.95**

General-Class License Preparation. Includes study manual and two code cassettes. **62-2412** **19.95**

ARCHER® HIGH-DEFINITION/STEREO-CERTIFIED COLOR SUPREME *Plus*™

3 ANTENNAS
IN ONE
VHF ■ UHF
FM

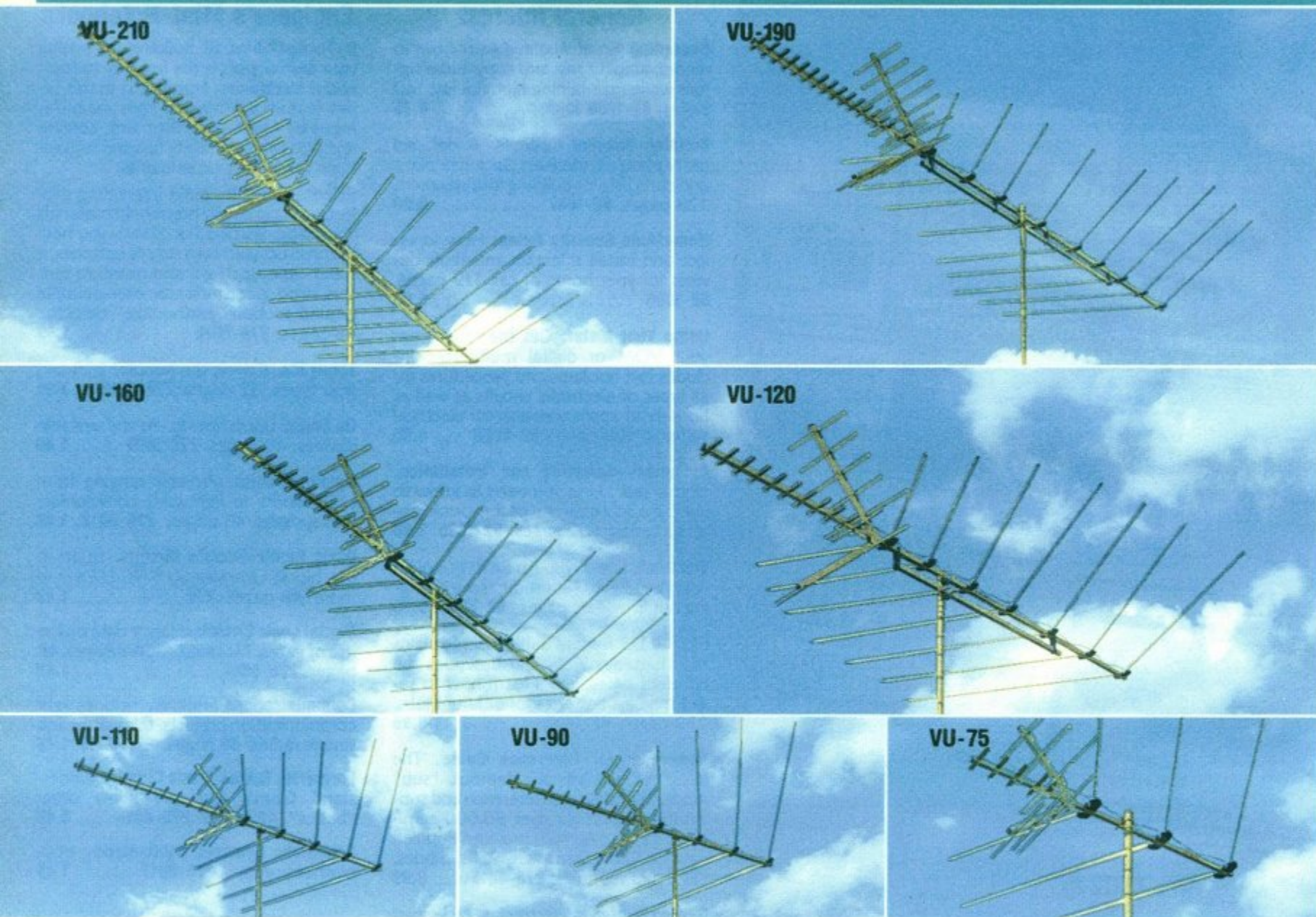

**Radio Shack is
America's #1
antenna and
accessory store!**

- Manufactured by us in our own USA factory
- We carry a complete selection of accessories

Our Color Supreme Plus series is the best-selling TV and FM antenna line in the USA. It provides outstanding reception at an outstanding value. But that's not all. In addition to antennas, we have filters and amplifiers, masts and guy wires, cables and connectors, mounting hardware, and much more. No wonder we're America's favorite antenna center!

There's a Color Supreme Plus Just Right for Your TV and FM Reception Area

Our exclusive High-Definition/Stereo-Certified design visibly improves reception. High-Definition means you get performance that matches the improved picture resolution of the superb TVs now available. Stereo-Certified means you get the best possible sound from the hundreds of TV stations now broadcasting in stereo. You'll also get superior FM stereo. Built to withstand strong winds and icing. And their gold-alodized finish fights corrosion and weathering. Factory preassembled for easy installation.

Archer Model	Range in Miles*			Boom Length	No. of Elements	Cat. No.	Each
	VHF	UHF	FM				
VU-210	210	135	120	190"	56	15-1647	119.97
VU-190	190	120	100	160"	48	15-1646	89.97
VU-160	160	100	100	140"	40	15-1645	69.97
VU-120	120	90	90	120"	35	15-1644	56.97
VU-110	110	90	90	100"	30	15-1643	43.97
VU-90	90	70	70	80"	25	15-1642	35.97
VU-75	75	50	50	50"	17	15-1641	26.97

Built Better to Last Longer



High tensile-strength aluminum for long life



Snap-open elements for easy installation



UHF yagi and corner reflector combination



Air-insulated multiple-drive system



Strong square boom with "no-tilt" clamp



Heavy-duty, high-impact molded insulators

Choose an Archer® antenna for outstanding reception



Aim Your Antenna With Precision for the Best TV/FM Reception

Archerotor® System. A properly oriented antenna helps to eliminate annoying ghosts and interference. This remote control rotator precisely aims your antenna for the strongest, clearest signal from every station in range. An indicator on the remote shows which direction the antenna is pointing. Fits 1 1/4" to 1 3/4" masts. UL listed AC. Requires 3-conductor cable. (TSP) 15-1225 . . 59.95

Rotator Cable

No. Cond.	Feet	Cat. No.	Per Roll
3	50	15-1149	5.49
3	100	15-1150	8.95
5	100	15-1201	13.39

Note: 5-conductor cable is for older model rotators.



Compact Amplified Antenna

Fits closet, attic, RV. Boosts UHF gain by 25 dB, VHF/FM by 20 dB. With mounting hardware and UL listed AC adapter, DC adapter jack. 15-1611 54.95
DC Adapter. 270-1534 5.99



New! Mobile VHF/UHF Antenna

Our best mobile TV antenna. It's sleek and aerodynamic, and mounts magnetically or permanently on roof or rear deck. Can be painted to match vehicle. With 14-ft. coax cable and 300-ohm matching transformer. 15-1614 . . 49.95

Mobile VHF/UHF Antenna

Enjoy your favorite TV shows while traveling. Install/remove on window or gutter in seconds. Fiber glass dipoles outperform built-in antennas. 15-1609 . . 29.95



Portable Amplified Antenna for Pocket TVs and FM

The pocket-size solution for poor reception. Built-in amp boosts TV and FM signals. With UL listed AC adapter. Amplifier requires 2 "AA" batteries for portable use. 15-1607 . . 24.95

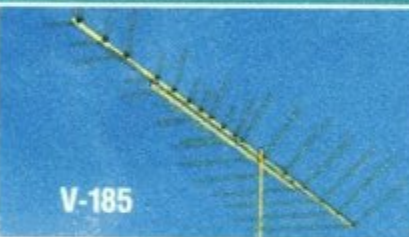

V-185



U-120



U-100



U-75

Our Best VHF/FM Stereo

Up to 185 Miles* VHF, 110 Miles* FM. Swept-wing design provides outstanding reception of channels 2-13 and FM stereo. Reinforced 160" cradle-boom with 34 elements. Pre-assembled. 15-1654 59.95

Our Finest UHF Only

Up to 120 Miles* UHF. Specially tuned for precise band coverage of hard-to-get channels 14-83. Heavy-duty 100" square boom resists high winds. Has 33 elements. Preassembled. 15-1662 34.95

Ideal for Distant Stations

Up to 100 Miles* UHF. Corner reflector yagi concentrates signal to improve the long-range reception of channels 14-83. Has 25 elements on the 80" square boom. Preassembled. 15-1661 23.95

Lowest-Priced UHF Only

Up to 75 Miles* UHF. Narrow pick-up pattern helps "tune-out" interference—ideal for urban/suburban reception of channels 14-83. Has 16 elements, 60" boom. Pre-assembled. 15-1660 16.95

Convenient Window-Mount Antenna

■ For VHF/UHF-TV channels 2-83 and FM stereo

End that poor "rabbit-ear" reception of TV and FM with this easy-to-install, custom-crafted antenna. Mounts to the window frame—perfect for apartments, condos and anywhere where a roof-mount antenna is not convenient or recommended. Factory preassembled—designed for do-it-yourself installation and removal. 15-1656 44.95



Compact Indoor/Outdoor Antenna

Highly efficient design delivers outstanding reception of VHF channels 2-13 and UHF channels 14-83, as well as FM stereo. The boom is only 71" long, so you can easily install it in the attic—or anywhere space is limited. 15-1655 34.95

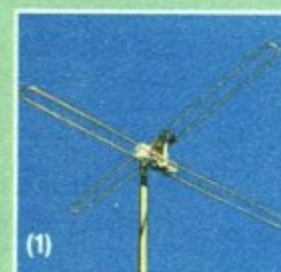

(1)



(2)

FM and FM Stereo Antennas

(1) **Omnidirectional Outdoor**—Up to 50 Miles*. For city or suburbs. Pulls in stations from all directions—360° pickup pattern. 15-1639 12.95

(2) **Triple-Drive Directional**—Up to 110 Miles*. High gain picks up distant stations clearly. Preassembled for easy installation. 15-1636 16.95

Everything you need to easily install your antenna is at your nearby Radio Shack store

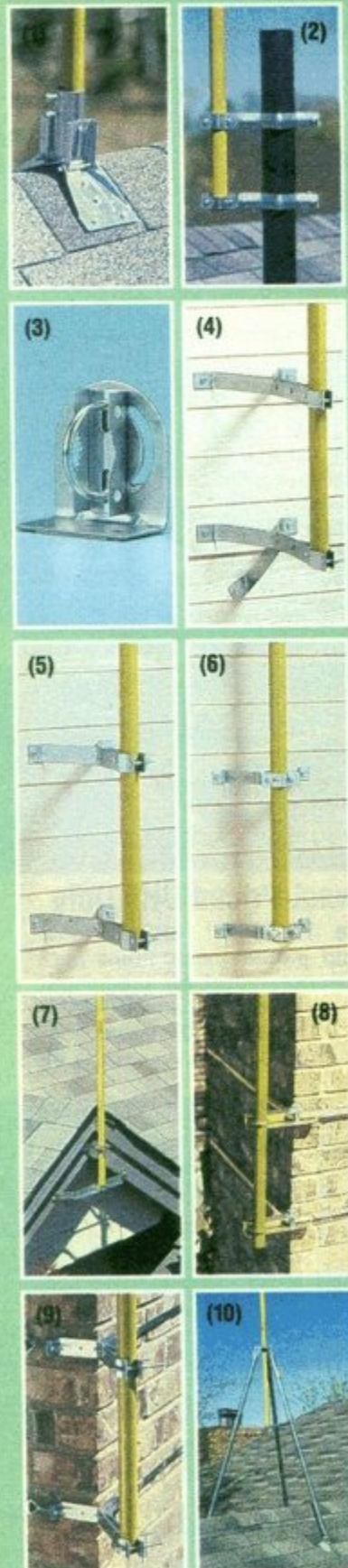

First-Quality Mast Mounts for Roof, Eave, Vent Pipe, Chimney and Wall

- (1) **Base and Roof Mount.** Mast locks into exclusive-design U-bolt. Swivel base fits the slope of virtually any roof. Heavy-gauge steel construction assures a trouble-free installation. 15-889 ... 7.19
- (2) **Vent Pipe Mount.** Alternative to chimney mounting for small antennas. Attach brackets to vent pipe, then clamp mast into place. For 2" to 5" vents. Heavy-duty steel construction. 15-893 ... 5.95
- (3) **Universal Mast Anchor Mount.** The low-cost solution for many antenna installations. Heavy-duty U-bolt for easy swivel. For masts up to 1 1/2" in diameter. (Mast must be guyed for roof and window installations.) 15-888 ... 3.19
- (4) **12" Wall Mounts.** Secures a mast of up to 1 3/4" diameter at 12" from the side of building. Allows mast to clear eave or other obstruction. Galvanized steel. 15-885 ... Pair 12.49
- (5) **8" Wall Mounts.** Holds mast of up to 1 3/4" diameter at 8" from side of building. 15-886 ... Pair 9.95
- (6) **4" Wall Mounts.** Holds mast of up to 1 3/4" diameter at 4" from side of building. 15-883 ... Pair 4.89
- (7) **Eave Mount for Hanging Rafters or Trim Boards.** Alternative to roof and chimney mounting—install antenna without drilling through brick or masonry. Fits virtually all medium-pitch roofs. Accepts mast up to 1 1/2" diameter. Installs with four included lag bolts. 15-891 ... 9.95
- (8) **Chimney Ratchet Mount.** Provides secure mounting to chimney. Tightens with screwdriver. Set includes two stainless steel straps, each 3/4" x 18 feet. Fits larger chimneys. Accepts antenna mast from 1" to 1 3/4" diameter. 15-839 ... 17.95
- (9) **Corner Mounts.** Just the thing for chimney mounting. Two Y-mounts with 5/8" x 10-foot, rust-resistant galvanized straps. 15-527 ... 10.95
- (10) **3-Foot Tripod Mount.** Ideal for larger antennas and in areas subject to frequent strong winds. Fits slope of most roofs. Accepts antenna mast up to 1 3/4" diameter. Preassembled. 15-516 ... 15.95

Telescoping Antenna Masts

(1) Sections interlock—won't pull out, twist or shake. Resists corrosion. Clamp and guy ring give firm support.

19-Foot Mast. One 16-gauge, one 18-gauge section. 15-5065 ... 35.95

36-Foot Mast. One 16-gauge, three 18-gauge sections. 15-5067, 57.95

Base and Mount

(2) **Roof Base.** With holding bolt. 15-5068 ... 6.99

(3) **Ground Mount.** Secures up to 36-ft. masts. 15-5069 ... 9.95

(4) **Guy Wire.** Six-strand, 18-gauge. 100 feet. Galvanized. 15-5070 ... 7.59

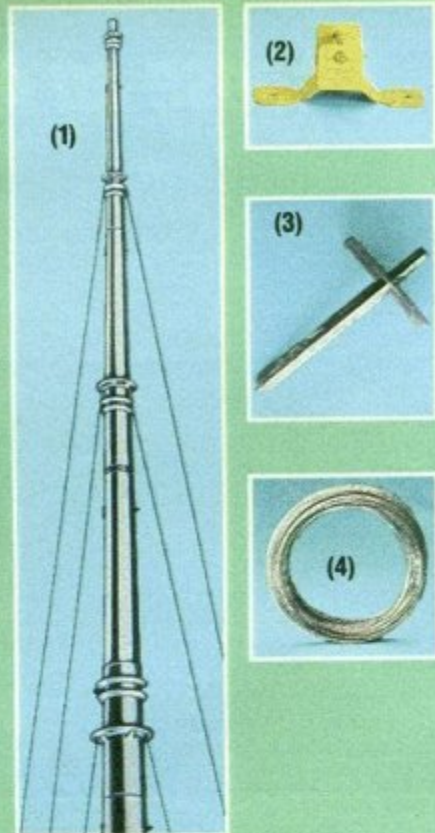

Heavy-Duty Masts

5-Foot. 16-gauge steel, enamel finish. Tapered end. 1 1/4" dia. 15-842, 5.29

10-Foot Mast. 15-843 ... 10.49

Light-Duty Mast

5-Foot. 20-gauge steel. Enamel finish. For use in attic or with smaller antennas. 15-844 ... 4.69

Antenna Hardware and Accessories

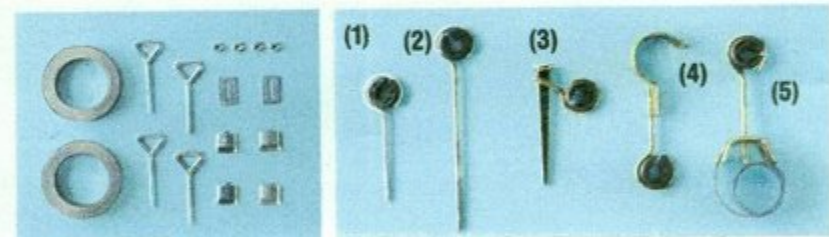

25-Foot Strap Kit

Two 25-foot stainless steel straps for replacement of present straps or for add-on use. Just the thing for oversized chimneys. Each 3/4" x 25-ft. Complete with four eye bolts and all mounting hardware. 15-801 ... 12.95

Standoff Insulators

Fig.	Description	Cat. No.	Each
1	4 Wood Screw, 3 1/2"	15-853	1.10
2	4 Wood Screw, 6 1/2"	15-854	1.29
3	2 Masonry Type	15-820	1.29
4	2 Snap-Grip Type	15-822	1.10
5	2 Strap-On Type	15-823	1.10

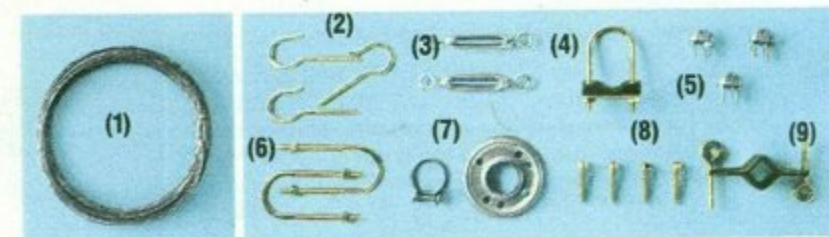

Antenna Guy Wire and Additional Hardware

Fig.	Description	Cat. No.	Each	Fig.	Description	Cat. No.	Each
1	50-Foot Galvanized Wire	15-030	1.69	6	2 U-Bolts With Nuts	15-830	1.29
1	100-Foot Galvanized Wire	15-031	2.79	7	1 1/2" Guy Ring and Collar	15-835	1.59
2	3 Guy Wire Anchors	15-825	1.29	8	Set of 4 Hex Lag Bolts: 1/4 x 2 1/2" for Heavy-Duty Mounting	15-833	1.10
3	2 Guy Wire Turnbuckles: 6" open, 4" closed	15-829	1.79	9	Guy Wire Mast Clamp With Bolts	15-827	1.29
4	U-Bolt and Clamp	15-826	1.29				
5	3 Guy Wire Clamps	15-850	1.29				

Archer® antenna accessories are tops for improving your TV's picture

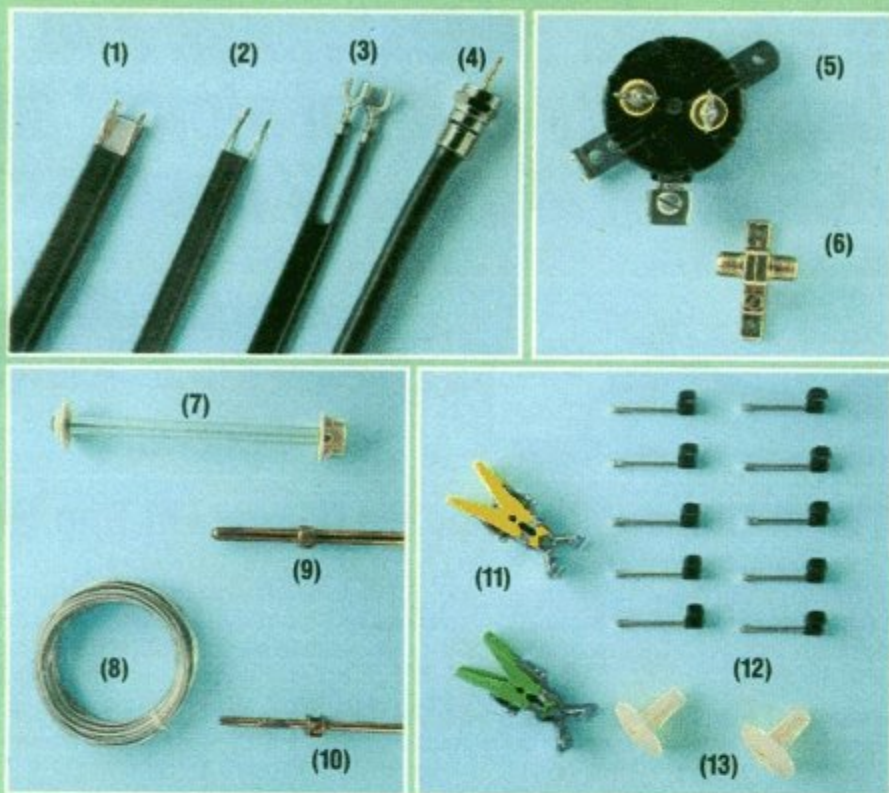

Lead-In Cable, Grounding Equipment and Hardware for Antenna Installations

- (1) VHF/UHF 300-Ohm Foam Cable. Low loss, with 20-ga. copper conductors and polyethylene jacket. 50 Feet. 15-1174 5.29 100 Feet. 15-1175 9.49
- (2) Economy VHF/UHF 300-Ohm Cable. Lighter weight cable than (1). Indoor use. 40 Feet. Brown. 15-004 2.29 40 Feet. Clear. 15-1158 2.29 50 Feet Standard 300-Ohm Twin-Lead. Indoor/attic use. 15-1153 3.59
- (3) 8-Foot Twin-Lead Cable. 15-1532 2.29
- (4) Shielded 75-Ohm VHF/UHF Foam Coax Assemblies. Prewired F connector at ends. 50 Feet. 15-1526 9.29 100 Feet. 15-1527 15.49
- (5) Antenna Discharge Unit. For antennas using 300-ohm lead-in. 15-910, 3.49
- (6) Grounding Block. Prevents static buildup in 75-ohm lead-in. 15-909, 2.59
- (7) "Wall-Thru" Lead-in Tube. Seals walls up to 13" thick. 15-1200 2.79
- (8) Aluminum Ground Wire. Protects against static buildup in rooftop antennas. 40 feet. 8 gauge. Use with ground rod (fig. 9). 15-035 3.59
- (9) UL Listed 8-Foot Ground Rod and Clamp. Copper plated. 15-529 15.95
- (10) Economy Ground Rod. 4 feet long. 15-530 7.95
- (11) TV/FM Antenna Clips. Instant connect and disconnect of 300-ohm lead-ins at back of set. For temporary connections or service work. 15-832, Set of 2/1.49
- (12) Coax Nail-In Clips. Weather-resistant clips secure 75-ohm coax cable along outside trim or interior baseboards. 20-192 Set of 10/99¢
- (13) Coax Feed-Through Bushing. For installation of coax cable through walls. For RG59 Cable. 278-1643, Pkg. of 2/49¢ For RG6 Cable. 278-1644, Pkg. of 2/49¢

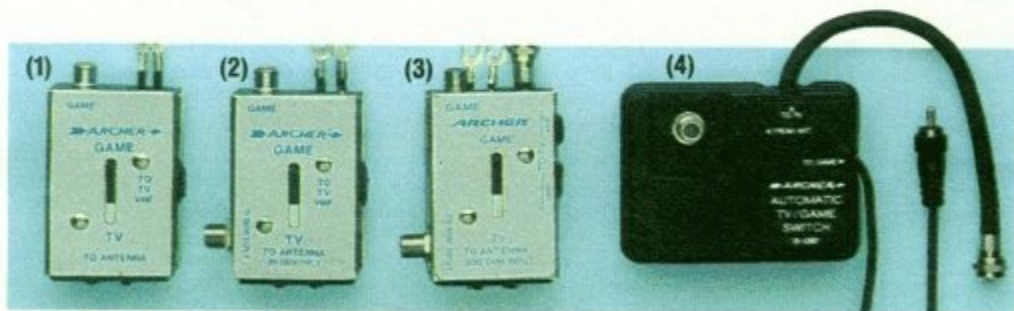

Handy Selector Switches by Archer for TV Video Games

- (1) 300-Ohm TV Switch. Lets you use a video game with your TV without reconnecting each time. Accepts 300-ohm TV antenna lead-in. Has 300-ohm TV output. 15-1255 ... 4.29
- (2) 300/75-Ohm Antenna Input Switch. Switch easily between TV antenna and video game. Has 300-ohm TV output. Accepts 75-ohm or 300-ohm antenna lead-in. 15-1269, 4.29
- (3) 300/75-Ohm Signal Splitter/Switch. Built-in signal splitter. Provides 300-ohm output for UHF, 75-ohm output for VHF. 15-1268 6.29
- (4) Automatic TV/Game Switch. With 75-ohm TV antenna input, 75-ohm TV output. Ideal for use with Nintendo™ TV game. 15-1267 8.99

Nintendo and Nintendo Entertainment System are registered trademarks of Nintendo of America, Inc.

Splitters, Couplers

- (1) Two-Set Indoor/Outdoor Splitter/Coupler. Splits 300-ohm lead-in to two TVs or joins two antennas to one lead-in. 15-1135 3.99
- Four-Set In/Outdoor Splitter/Coupler. 15-1136 4.99
- VHF/UHF Combiner/Splitter. 300 ohms. 15-1137 3.99
- (2) Indoor Splitter. Splits UHF/VHF/FM outputs from one 300-ohm download. 15-1138 3.99

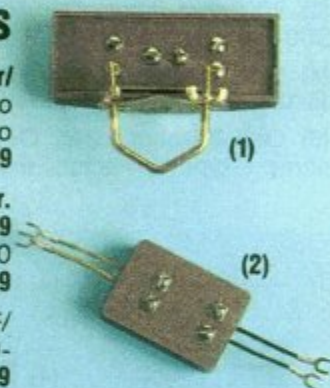

Cords, Plates, Plugs 'n More

- (1) TV AC Power Cord. Six feet long. 15-011 1.39
- Polarized AC Power Cord. 15-012 1.39
- (2) Private TV Listener. Fits 1/8" jack. With earphone, remote volume control and 15 foot cord. 15-587 4.29
- (3) Wall Plate for 75-Ohm Coax. 15-1180 4.29
- (4) Wall Plate for 75-Ohm Coax and Rotator. 5-wire rotator outlet. Includes plugs. 15-1181 4.99
- (5) Wall Plate for 75-Ohm Coax and Phone. Standard modular phone jack and gold-plated coax connector. 15-1185 5.95
- (6) Woodgrain 75-Ohm Wall Plate. 15-1183 4.49
- (7) 75-Ohm Dual-Outlet Wall Plate. 15-1184 4.69
- (8) Flush-Mount TV Wall Plate. For one 300-ohm lead-in. Includes mounting bracket and plugs. 15-1186 2.39
- (9) Baseboard-Mount 75-Ohm Coax Connector. With installation hardware. 15-1182 3.29
- (10) TV/Wall-Socket Plugs. For 300-ohm lead-in plate. Fit fig. 8. 15-1178 Pkg. of 2/1.39
- (11) Plug and Socket. For 300-ohm lead-in connections. Ideal for splicing and extending a 300-ohm cable indoors. 15-1198 1.39

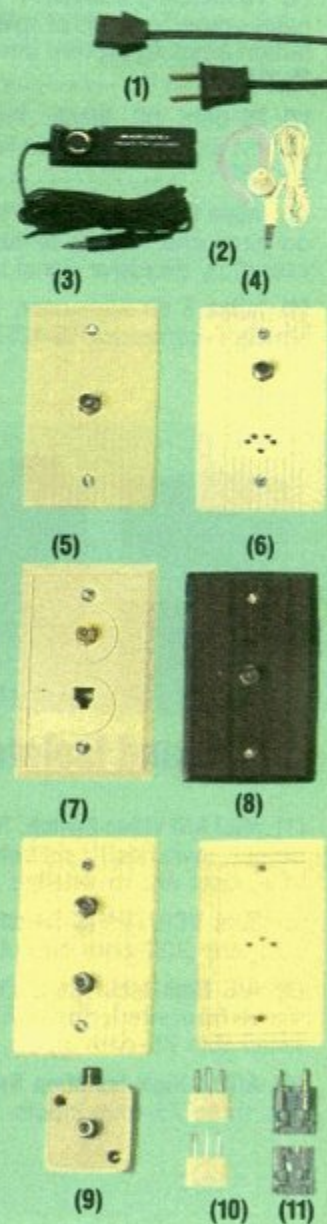

We have the widest range and best quality to meet almost any configuration in VCR/TV hookups

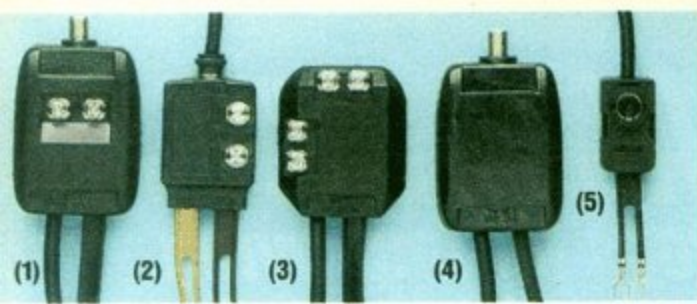

VCR/TV Signal Splitters

- (1) One 75-ohm input. One 75-ohm output for VHF. 300-ohm outputs for UHF and FM. 15-1252 4.99
- (2) 75-ohm input, 300-ohm outputs for UHF, VHF and FM. F-connector. 6-foot cable. 15-1524 6.19
- (3) 300-ohm input. One 75-ohm output for VHF, plus 300-ohm outputs for UHF and FM. 15-1251 4.99
- (4) One 75-ohm input. 75-ohm VHF and UHF outputs. 15-1293 4.99
- (5) One 75-ohm input. Outputs for 300 ohms and 75 ohms. F-type connectors. 6-foot cable. 15-1522 4.99

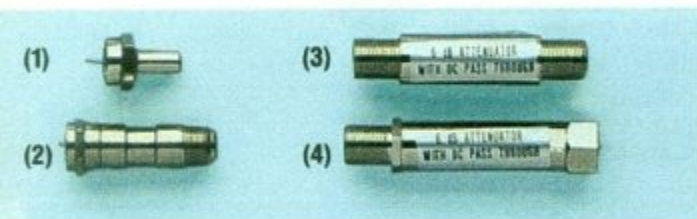

Attenuators, Resistor & DC Block

- (1) **Terminating Resistor.** F-type, 1-2 watt, 75 ohms. Terminates unused outputs of splitters, coax wall plates and distribution amps to prevent interference and ghosts. 15-1144 2/1.19
- (2) **75-Ohm DC Block.** Protects your video equipment against DC voltages from line-powered equipment. 15-1259 1.49
- (3) **Inline 6 dB Attenuator.** 75-ohm. With female F-connector on each end. Works to reduce or eliminate interference caused by excessive signal strength. 15-1258 2.29
- (4) **Inline 6 dB Attenuator.** As above, but with male F to female F-connector. 15-1257 2.29

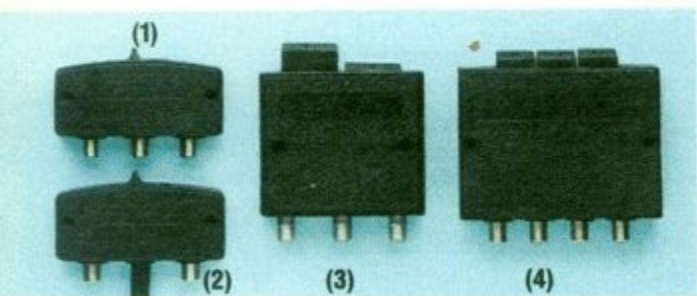

Mini and Isolated Video Switches

- (1) **Mini A/B Video Switch.** Two 75-ohm inputs, one 75-ohm output. Switches TV set between any two of antenna, cable, VCR, laser disc or satellite. Reversible. 15-1247 4.99
- (2) **Mini VCR/TV/FM Switch.** Two switchable 75-ohm inputs, one 300-ohm output. Reversible. 15-1246 4.99
- (3) **A/B High-Isolation Switch.** Helps prevent strong input signals from interfering with each other. 75-ohm output, two switchable 75-ohm inputs. Reversible. 15-1249 6.99
- (4) **A/B/C High-Isolation Switch.** Pushbutton. 75-ohm output, three 75-ohm inputs. Reversible. 15-1248 10.99

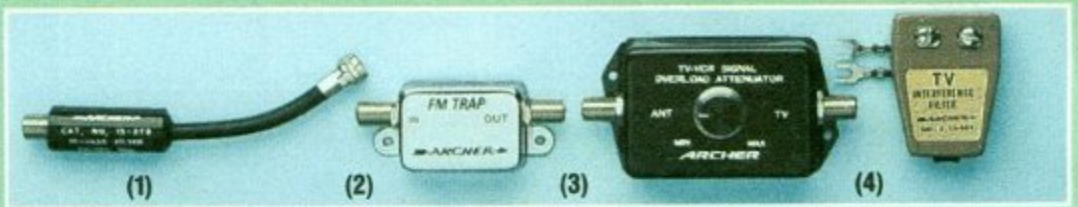

TV/FM Filters, Attenuator and Coaxial FM Trap

- (1) **VCR/TV/FM.** Cuts CB/Ham interference. Hi-pass LC (inductive capacitive) filter installs at 75-ohm coaxial input of VCR, TV or FM. 54-900 MHz. 15-579 4.29
- (2) **Coaxial Inline FM Trap.** For 75-ohm line. Cuts interference from strong FM radio stations on TV or VCR to reduce "herringbone" pattern. 15-577 3.69
- (3) **75-Ohm Attenuator.** Reduces strong signal overload on TV or VCR. Connects inline to coaxial cable. Adjustable for best possible picture. 15-578 6.39
- (4) **TV Static/Noise Filter.** Reduces or eliminates appliance, motor or neon light interference. Attaches to 300-ohm terminals. 15-582 1.99

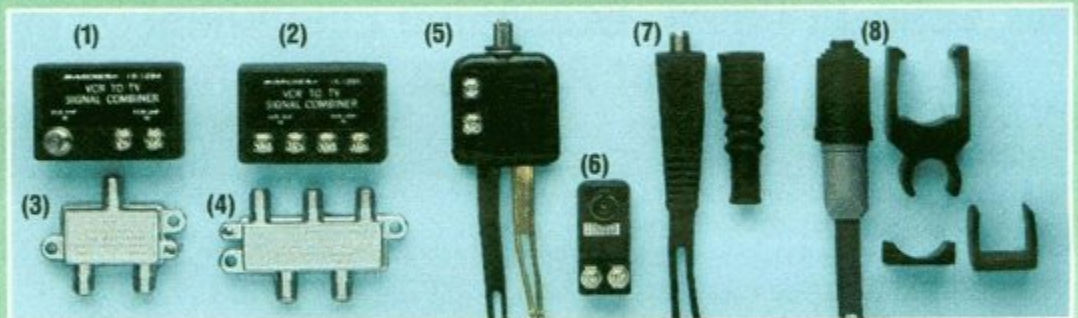

Splitter/Combiners and Matching Transformers

- (1) **VCR/TV Splitter/Combiner.** 300/75-ohm inputs, 75-ohm output. 15-1294 3.79
- (2) **300-Ohm Splitter.** As above, but only 300-ohm inputs. 15-1295 3.79
- (3) **Hybrid Splitter/Combiner.** Splits 75-ohm coax cable to two VHF/UHF outputs. F-connectors. Reversible. 15-1141 3.95
- (4) **Four-Set Splitter.** As above, but with four outputs. 15-1142 6.95
- (5) **Transformer/Splitter.** 75-ohm input for coax from antenna or VCR. Three 300-ohm outputs to VHF, UHF, FM. Indoor use only. 15-1139 4.99
- (6) **Matching Transformer.** 75-ohm to 300-ohm. 15-1253 2.99
- (7) **Indoor/Outdoor Matching Transformer.** Matches 300-ohm antenna to 75-ohm coax downlead. Reverse for back-of-set use. Weather-resistant boot. 15-1140 2.79
- (8) **Antenna-Mounted Matching Transformer.** As above, with clip for attaching to antenna boom. With weather-resistant boot. 15-1143 3.99

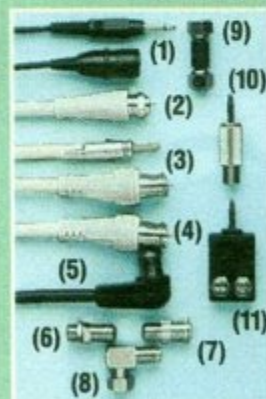

Fig.	Description	Connectors	Cat No.	Each
1	Mini-TV Antenna Cable, 6 Ft.	1/4" Plug/Male F	15-1511	4.95
2	75-Ohm Coax, 16 Ft. White	Male F Screw Type	15-1531	4.89
2	75-Ohm Coax, 25 Ft. White	Male F Screw Type	15-1534	6.19
3	75-Ohm Coax, 8 Ft.	Male F/Motorola	15-1528	3.59
4	75-Ohm Coax, 8 Ft.	Male F Push-On	15-1530	3.59
4	75-Ohm Coax, 4 Ft.	Male F Push-On	15-1529	2.79
5	75-Ohm Coax, 6 Ft.	Male F Push-On	15-1536	2.99
6	F-81 Coupler	Female F/Female F	278-213	.99
7	Push-On Adapter	Female F/Male F	278-218	1.49
8	Right Angle Coupler	Female F/Male F	278-221	1.29
9	Coupler	Male F/Male F	278-219	1.29
10	Adapter	Female F/Miniplug	278-257	1.99
11	75/300 Ohm Adapter	1/8" Miniplug	15-1148	1.49

Coax Cable, Connectors and Adapters

If you don't find what you need here, Radio Shack can custom-cut cable to meet almost any need. We also carry a wide range of connectors and adapters to make fitting your home entertainment system together easy.

Video/Computer RF Modulator
Converts line-level signal to VHF—makes TV a monitor. 1000-ohm and 75-ohm input jacks, 75-ohm output. FCC registered. UL listed AC. 15-1273 27.95

Plug-In AC Line Filter
Cuts snow and other TV interference produced by common household appliances. Has a 3-prong (grounded) AC plug and 3-prong outlet. UL listed AC. 15-1111 12.95

Solve your TV, VCR, FM or stereo hookup problems with gold

Gold is one of the densest elements—a superb conductor that lets signals flow with minimum resistance, enhancing your system's performance.

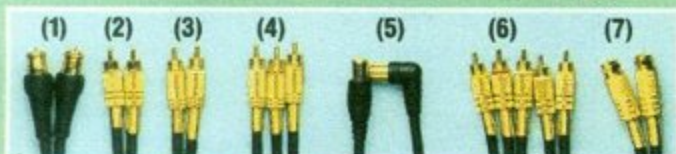

Cables With Gold-Plated Plugs

Fig.	Length	Connector Type	Cat. No.	Each
1	3-Foot	Push-On F	15-1515	3.59
	6-Foot	Push-On F	15-1516	4.29
	12-Foot	Push-On F	15-1517	4.99
2	3-Foot	RCA Phono	15-1518	4.89
	6-Foot	RCA Phono	15-1519	5.69
	12-Foot	RCA Phono	15-1520	7.99
3	3-Foot	A/V Cables	15-1504	6.49
	6-Foot	A/V Cables	15-1505	7.49
	12-Foot	A/V Cables	15-1506	9.99
4	3-Foot	Stereo, A/V Cables	15-1507	9.49
	6-Foot	Stereo, A/V Cables	15-1508	10.99
	12-Foot	Stereo, A/V Cables	15-1509	14.99
5	3-Foot	Right-Angle Push-On F	15-1513	3.99
	6-Foot	Right-Angle Push-On F	15-1514	4.49
6	6-Foot	RCA Phono (Video Dubbing Cable Set—Stereo to Mono)	15-1521	9.95
	6-Foot	NEW! RG6 F-Screw Type	15-1541	6.95
7	6-Foot	NEW! RG6 F-Screw Type	15-1542	7.95
	12-Foot	NEW! RG6 F-Screw Type	15-1543	9.95



Premium-Quality Gold-Plated A/V Dubbing Kit

Get true, accurate dubs every time. Includes two F-type to phono jack and two 1/8" mini-plug to phono jack adapters, and 6-foot cable with phono plugs on ends. **15-1523 12.95**
Kit With Chromium-Plated Plugs. 15-1525 6.95

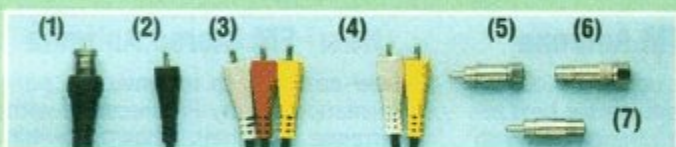
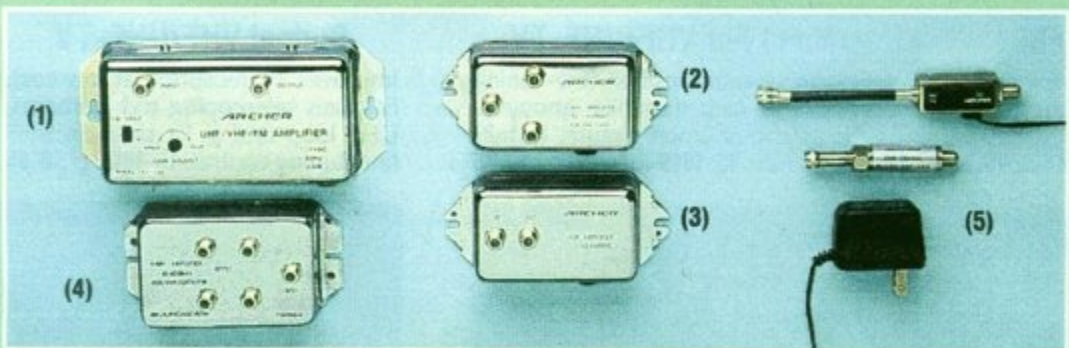

Fig.	Description	Cat. No.	Each
1	2-Foot Coax Cable, Male Push-On Connectors	15-1533	2.69
2	2-Foot VCR A/V Cable, Phono Connectors	15-1538	2.29
2	6-Foot VCR A/V Cable, Phono Connectors	15-1535	3.99
2	12-Foot VCR A/V Cable, Phono Connectors	15-1539	5.19
3	6-Foot Stereo A/V Cable, 3 Phono at Each End	15-1537	7.19
3	12-Foot Stereo A/V Cable, 3-Phono at Each End	15-1512	8.95
4	Dual 24-Foot A/V Cable, Phono Connectors	15-1540	8.29
5	Adapter, Male F-Connector to Phone Plug	278-253	1.99
6	Adapter, Male F-Connector to Female Phono Jack	278-255	1.29
7	Adapter, Female F-Connector to Phone Plug	278-252	1.39

Cables, Connectors and Adapter for Audio and Video Hookups

Having trouble figuring out what type of connection you need for your audio or video system? Just bring your cable or component to your nearby Radio Shack store and our friendly staff will assist you. We have hookup accessories to help complete almost any home entertainment system.



End Problems With Weak Signals and Ghosts With Our VHF, UHF, FM and CATV Signal Boosters for Use With 75-Ohm Coax Cable

(1) VHF/UHF/FM Amplifier. Adjustable 10 to 20 dB gain. Switchable FM trap cuts interference. Can be used with hybrid splitters to drive up to four TVs or four VCRs. UL listed AC. **15-1113 23.95**

(2) Two-Set Amplified Coupler. Boosts signal from VHF, FM mid and superband cable TV. UL listed AC. **15-1116 13.95**

(3) 10 dB Booster-Amp. Strengthens signal from VHF, FM mid and superband cable TV. UL listed AC. **15-1118 12.95**

(4) Four-Set Amplified Coupler. Boosts VHF, FM, mid and superband cable TV signal to drive any combination of four TVs, VCRs or FM receivers. Lets you use one antenna or cable box for the whole house, cuts signal loss on long cable runs. UL listed AC. **15-1119 15.95**

(5) 10 dB Inline Coax Amplifier. "Bullet" -type amplifier connects in-line with your coaxial cable, near antenna for maximum benefit. Reduces VHF/UHF/FM signal loss from splitters, transformers and long cable runs. UL listed AC. **15-1117 17.95**



New! 70-Channel 2-Way Cable Amplifier

Connects your antenna or cable to any two video receivers. Boosts signals up to 20 dB for better picture and sound. UL listed AC. **15-1960 26.95**



70-Channel Cable TV Amplifier

Perfect for strengthening signal on installations with long cable runs. Adjustable 10-20 dB gain. Can be used with hybrid splitters (see #15-1142) to drive up to four TVs or VCRs. UL listed AC. **15-1112 24.95**



Three-Piece TV/FM High-Gain Signal Amp

■ Delivers typical gain of 25 dB VHF and 20 dB UHF for a better picture

Outdoor amp mounts on mast near antenna. Remotely controlled FM trap cuts interference. Gain adjustable over 10 to 20 dB range. 75-ohm output and F-connectors. UL listed AC. **15-1108 35.95**



75-Ohm Coax Cable Distribution Amplifier

■ Drives up to four sets
 ■ Delivers typical gain of 14 dB VHF, 13 dB UHF
 ■ Adjustable from 10 to 20 dB gain

Cuts VHF/UHF/FM signal loss caused by sharing signal among several TV sets or by long antenna cable runs. Switchable trap cuts FM interference. 75-ohm input/output. UL listed AC. **15-1107 31.95**

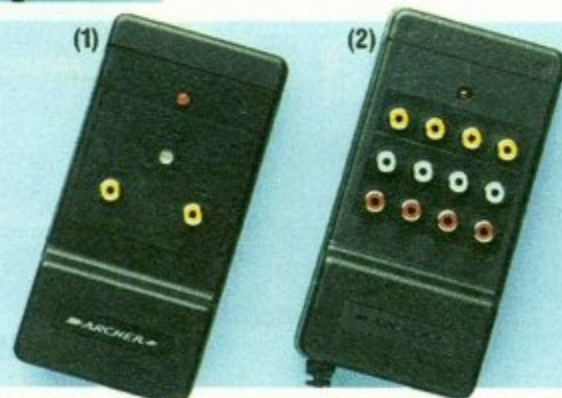

Video Signal Amplifiers

(1) Video Amplifier/Enhancer. Boosts base-band video signal for better picture from VCR, laser disc, satellite receiver or other video output. UL listed AC. **15-1102 19.95**

(2) Three-Set Audio/Video Distribution Amplifier. Amplifies and splits video signals for a stronger signal to each set—helps prevent loss from long cable runs. Drives up to three audio/video components. UL listed AC. **15-1103 29.95**

Indoor antennas



High-Power Amplified TV/FM

Color Supreme® 200. Gives 20 dB boost to VHF/UHF-TV and FM. Normal/boost switch eliminates strong-signal overload. UL listed AC. **15-1831 59.95**

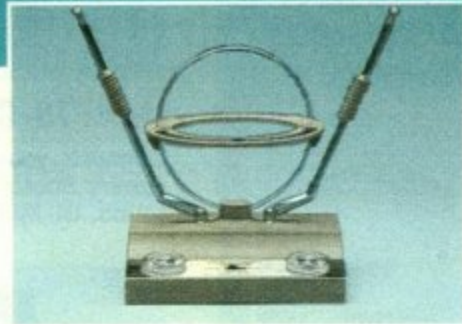

Amplified TV/FM

Color Supreme V. Boosts VHF/UHF TV and FM stereo signals up to 12 dB. Normal/boost switch cuts overload. UL listed AC. **15-1830 45.95**

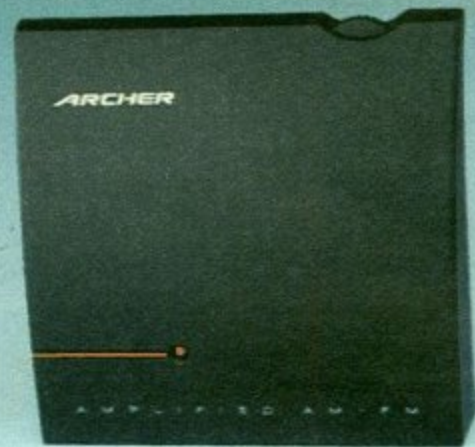

New! Amplified AM/FM Stereo Antenna

Combines compact styling and a low-noise, high-gain amplifier that boosts even the weakest FM signals. Includes matching transformer. Connects to receiver's 300-ohm or 75-ohm FM antenna terminals and AM terminals. $4\frac{7}{8} \times 4\frac{15}{16} \times 1\frac{3}{4}$ " UL listed AC. **15-1832, 39.95**



New! Rotatable TV/FM

Color Supreme 150. Rotary control lets you turn VHF and UHF elements without turning antenna base. 12-position fine-tuning control helps sharpen picture. **15-1826 . . . 29.95**



New! Rotating VHF/UHF-TV

Color Supreme 100. Rotary control steers VHF and UHF elements without turning the base. 12-position rotary fine-tuning control optimizes reception. **15-1825 24.95**



Amplified FM Antenna

Boosts FM signals up to 6 dB. Gain and fine-tuning controls for best reception. LED "on" indicator. With 300-ohm matching transformer. UL listed AC. **15-1821 29.95**



New! FM Stereo Antenna

Low-cost way to improve the performance of any FM receiver with antenna terminals. Phasing switch helps reduce multipath distortion. Felt cushion base. **15-1823 . . 12.95**

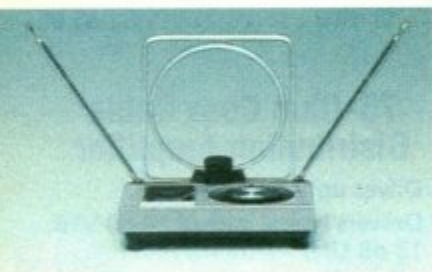

Adjustable TV/FM

Color Eagle® 100. Superior to built-ins. Has adjustable UHF elements and fine-tuning control. For set top or wall mounting. **15-1808 . . . 19.95**



High-Style TV/FM

Color Eagle. Adjustable UHF reflector dish plus 12-position fine-tuning control to maximize signal quality on VHF-TV and FM. **15-1807 . . 15.95**

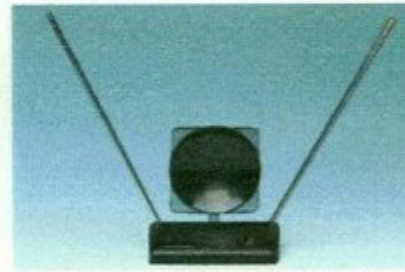

New! For VHF/UHF-TV

Features a multiposition fine-tuning control to help minimize annoying ghosts and sharpen picture. Installs in seconds. **15-1819 10.95**

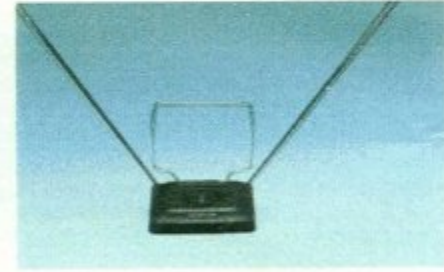

Budget VHF/UHF-TV

Improves TV reception at low cost. Features telescoping rod elements, UHF loop and a 12-position VHF fine-tuning control. **15-1806 . . 8.95**



VHF/UHF/FM Amplifier

Converts any nonamplified indoor antenna to an amplified antenna. 10 dB signal gain. Has an LED power "on" reminder light and separate VHF/FM and UHF output leads. Simple inline hookup. UL listed AC. **15-1104 19.95**

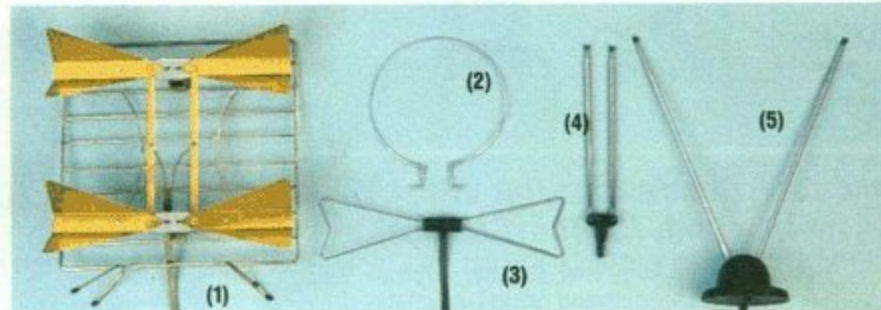

Affordable Solutions to TV Reception Problems

- (1) **UHF Double Bow-Tie.** Dual elements. Sits upright on TV. Protective vinyl foot covers. **15-623 15.95**
- (2) **UHF Loop.** Ideal replacement for missing back-of-set UHF loop-type antenna. **15-233 1.19**
- (3) **UHF Outline Bow-Tie.** Snaps on VHF antenna rod. **15-234 2.19**

- (4) **Replacement VHF Dipole.** Exact replacement for many back-of-set snap-in VHF-TV antennas. Rotatable telescoping elements. **15-235 4.95**
- (5) **Classic VHF-TV/FM Top-of-Set Antenna.** Adjustable telescoping rod elements. Base features a protective anti-skid material. **15-958 . . . 4.99**

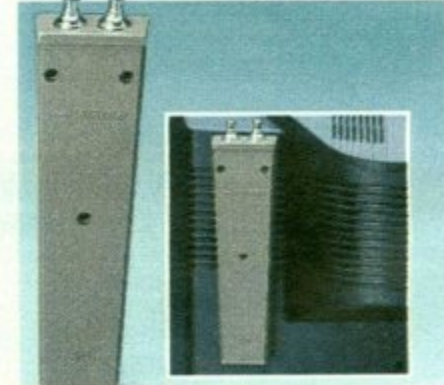

Back-of-Set VHF Dipole

Easy way to replace broken built-in rod elements. Mounts out of sight on back of set. Connects to external VHF antenna terminals. Telescoping 30" dipoles with swivel adjustment. With instructions. **15-1804 7.95**

Cables

America's hookup headquarters!
Big selection, tested quality, low prices

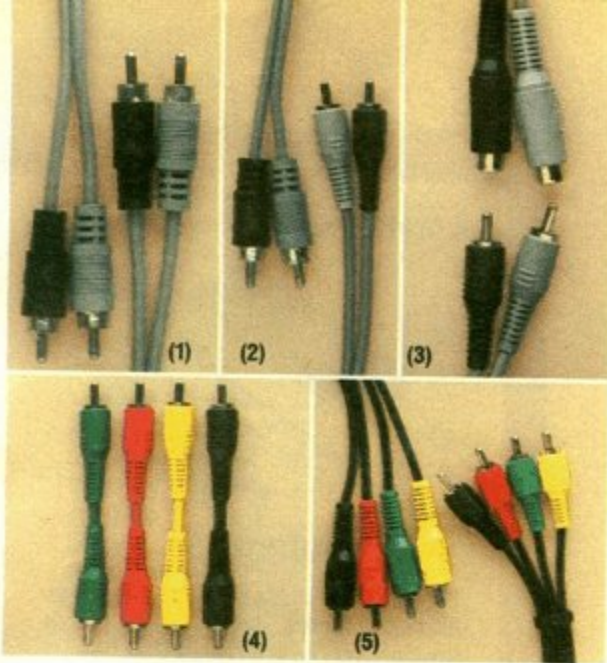

Audio Patch Cables

- (1) 12-Foot Stereo Cable. Has phono plug connectors at each end. Fully shielded to prevent hum and interference pickup. 42-2356 6.59
- (2) 3-Foot Stereo Cable. 42-2351 3.89
6-Foot Stereo Cable. 42-2352 4.39
- (3) 3-Foot Patch Extension Cable. Phono plugs at one end, phono jacks at the other. 42-2353 .. 3.99
- (4) Audio Cable Set. Four separate 3-foot cables with phono plug connectors. 42-2309 .. Set 5.69
- (5) Patch-Cable Ribbon. Assembly of four cables with phono plug connectors. Ideal for connecting a tape deck, equalizer or a signal processor to a stereo receiver or amplifier.
3-Foot. 42-2354 6.99
6-Foot. 42-2355 8.89

FM Wire Dipole Antenna

Superior to built-ins. Connects to any FM receiver or radio that has 300-ohm antenna terminals. 58" wide. 42-2385, 2.99

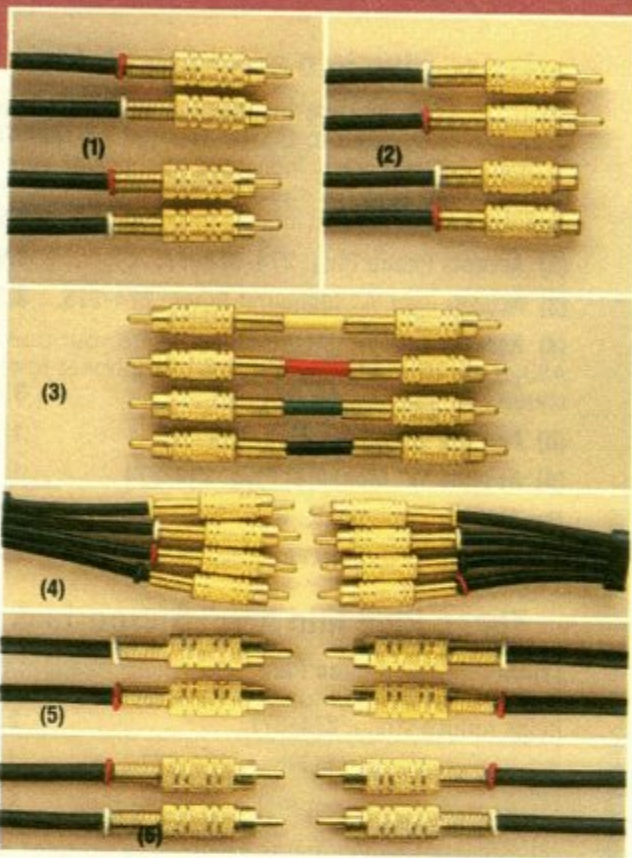
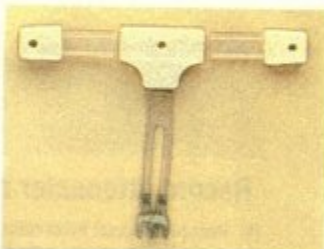

Shielded Cables With 1/4" Phone Plug

Fig.	Description	Feet	Cat. No.	Each
1	1/4" Plug to Phono Jack	6	42-2377	2.95
2	1/4" Plug to 1/4" Plug	6	42-2381	3.35
3	1/4" Plug to Phono Plug	6	42-2373	3.25
4	1/4" Plug to 90° Phono Plug	6	42-2440	2.89
5	1/4" Plug to 1/8" Mini Plug	6	42-2433	2.95

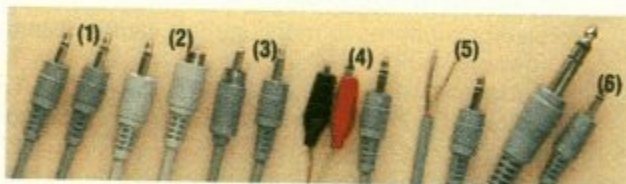

Shielded Cables With 1/8" Plug

Fig.	Description	Feet	Cat. No.	Each
1	1/8" Plug to 1/8" Plug	6	42-2420	2.35
2	1/8" Plug to 1/8" Jack	6	42-2472	3.25
3	1/8" Plug to Phono Plug	6	42-2444	2.19
4	1/8" Plug to Alligator Clips	6	42-2421	2.35
5	1/8" Plug to Stripped Ends	6	42-2434	2.35
6	1/8" Plug to Stereo 1/4" Plug	6	42-2157	3.99

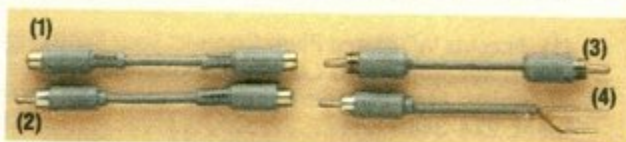

Shielded Cables With Phono Connectors

Fig.	Description	Feet	Cat. No.	Each
1	Phono Jack to Phono Jack	6	42-2358	2.55
2	Phono Plug to Phono Jack	3	42-2361	2.29
2	Phono Plug to Phono Jack	6	42-2362	2.45
2	Phono Plug to Phono Jack	12	42-2363	3.29
3	Phono Plug to Phono Plug	1 1/2	42-2365	1.79
3	Phono Plug to Phono Plug	3	42-2366	1.89
3	Phono Plug to Phono Plug	6	42-2367	2.45
3	Phono Plug to Phono Plug	12	42-2368	3.49
4	Phono Plug to Tinned Wire	3	42-2370	1.69
4	Phono Plug to Tinned Wire	6	42-2371	1.95
4	Phono Plug to Tinned Wire	12	42-2372	2.29

Gold

Our finest audio patch cables have premium gold-plated connectors to assure positive contact and superior signal transfer. Extra-heavy shielding locks out hum and interference.

- (1) 3-Ft. "Gold" Stereo Patch. Two phono plugs with strain relief at each end. 42-2601 9.95
- (2) 3-Ft. "Gold" Extension. Two phono plugs at one end and two inline phono jacks at the other end. 42-2602 9.95
- (3) 3-Ft. "Gold" Cable Set. Set of four cables with phono plugs at each end. 42-2603 16.95
- (4) 3-Ft. "Gold" Ribbon. Cable assembly with four phono plugs at each end. Ideal for connecting a tape deck or equalizer to stereo receiver or amplifier. 42-2604 16.95
- (5) 6-Ft. "Gold" Stereo Patch. Cable with two phono plugs at each end. 42-2605 11.95
- (6) **NEW!** 12-Foot "Gold" Stereo Patch. With two phono plugs at each end. 42-2606 14.95

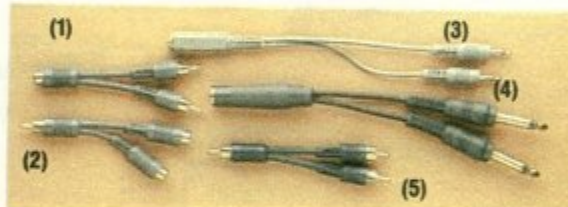

Shielded Y-Adapters

Fig.	Description	Length	Cat. No.	Each
1	Two Phono Plugs to Phono Jack	4"	42-2435	2.79
2	Phono Plug to 2 Phono Jacks	3"	42-2436	2.69
3	Two 1/4" Plugs to 1/8" Jack	4"	42-2158	2.99
4	Two 1/4" Plugs to 1/4" Jack	3"	42-2156	3.59
5	Two Phono Plugs to Phono Plug	4"	42-2438	2.29

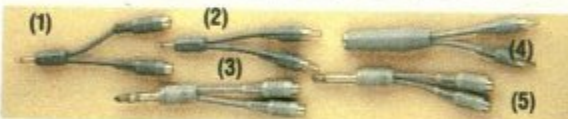

Shielded Phono Plug Y-Adapters

Fig.	Description	Cat. No.	Each
1	Two Phono Jacks to Mono 1/8" Plug	42-2154	2.29
2	Two Phono Plugs to Mono 1/8" Plug	42-2153	2.29
3	Two Phono Jacks to Stereo 1/4" Plug	42-2477	2.59
4	Two Phono Plugs to Stereo 1/4" Jack	42-2471	3.79
5	Two Phono Jacks to Mono 1/4" Plug	42-2150	2.29

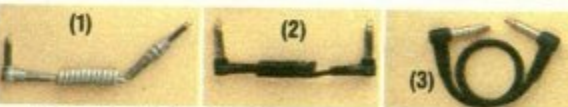

Shielded Guitar/Instrument Cords

- (1) 15-Ft. Coiled. Retracts to 3 ft. Straight 1/4" plug to 90° 1/4" plug. 42-2473 6.99
- (2) 12-Ft. Coiled. 90° 1/4" plugs. 42-978 4.99
- (3) **NEW!** 1-Foot Effects Patch. 1/4" plug to 1/4" plug. Ideal length for effects racks, processors. 42-2465 2.49

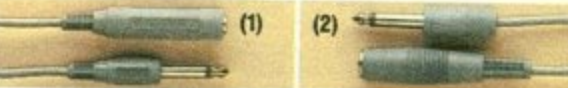

Shielded Mike Cable Extensions

- 1/4" plug at one end, 1/4" jack at the other.
(1) 25-Ft. 42-2379 .. 5.99 (2) 12-Ft. 42-2378 .. 4.29

6-Foot 1/8" and DIN Stereo Cables

- (1) Mini. 1/8" stereo plug at ends. 42-2387 .. 3.49
- (2) DIN. 5-pin male DIN plug at each end. European type stereo interconnect. 42-2151 4.99



Monaural Dubbing Cords

- (1) 6 1/2-Ft. 1/8" plug each end. 42-2152 3.39
- (2) 6-Ft. 1/8" plug one at one end, phono plug at the other. 42-2461 3.89

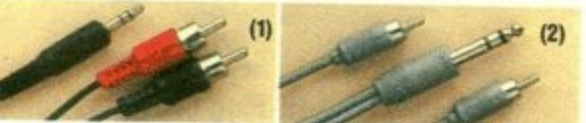

Shielded Y-Adapter Cords

- (1) Ideal for recording from CD player headphone jack. 1/8" stereo plug at one end, two phono plugs other end. 3-Ft. 42-2475 4.39 6-Ft. 42-2481 4.99
- (2) 6-Ft. 1/4" plug to two phono plugs. 42-2474 .. 5.95

Plug adapters

For the best,

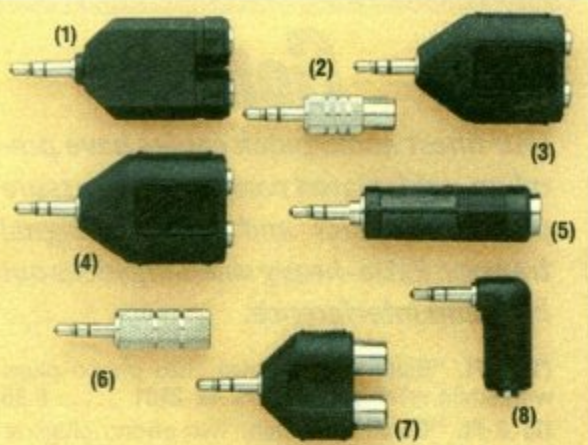

These Plug Into a 1/8" Stereo Jack

- (1) **NEW! Book-on-Tape Adapter.** Use your stereo cassette player to listen to books narrated on tape (in mono) and hear each individual channel of sound through both sides of stereo headphones. Provides two 1/8" jacks, labeled L and R. 274-396 2.99
- (2) **Accepts Phono Plug.** 274-378 1.99
- (3) **Accepts Two 1/8" Monaural Plugs.** 274-375, 3.39
- (4) **Accepts Two 1/8" Stereo Plugs.** Share your music! Allows you to connect two stereo headphones to one stereo headphone jack. 274-313 3.29
- (5) **Accepts 1/4" Stereo Plug.** 274-366 1.79
- (6) **Accepts 1/8" Monaural Plug.** 274-374 1.69
- (7) **Accepts Two Phono Plugs.** 274-369 2.49
- (8) **Accepts 1/8" Stereo Plug.** 274-372 2.49

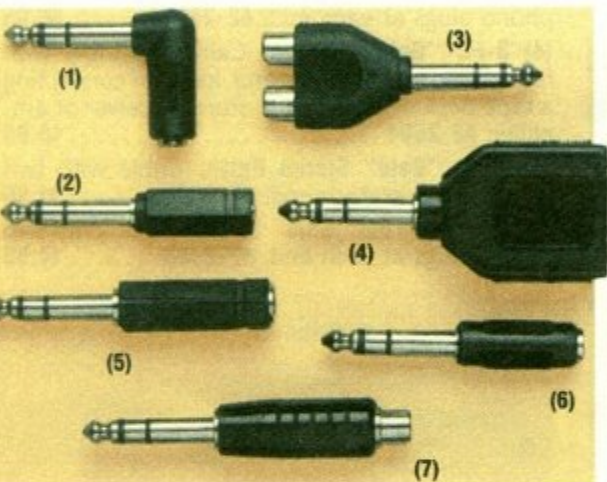

These Plug Into a 1/4" Stereo Jack

- (1) **Accepts 1/8" Stereo Plug.** Use "mini" headphones with a 1/4" stereo headphone jack. Right-angle design helps reduce strain. 274-371 2.99
- (2) **Straight Version of Fig. 1.** 274-367 1.79
- (3) **Accepts Two Phono Plugs.** 274-308 3.79
- (4) **Accepts Two 1/4" Stereo Plugs.** This adapter lets you connect two stereo headphones to one stereo headphone jack. 274-302 3.99
- (5) **Accepts 1/4" Monaural Plug.** Combines the left and right channels. 274-1520 1.99
- (6) **Accepts 1/8" Monaural Plug.** 274-363 1.99
- (7) **Accepts Phono Plug.** 274-365 1.39

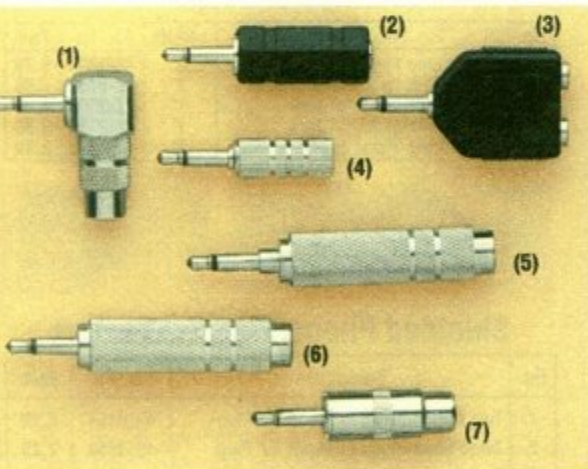

These Plug Into a 1/8" Monaural Jack

- (1) **NEW! Accepts Phono Plug.** The right-angle design helps reduce strain and damage to plug, jack and cable. 274-395 1.99
- (2) **Accepts 1/8" Stereo Plug.** Connect your lightweight stereo headphones to monaural TVs, radios, scanners and walkie-talkies. 274-368 1.19
- (3) **Accepts Two 1/8" Monaural Plugs.** 274-310 .. 1.99
- (4) **Accepts 3/32" Monaural Plug.** Connect an earphone with 3/32" plug to 1/8" jack. 274-328 1.79
- (5) **Accepts 1/4" Stereo Plug.** Use full-size stereo headphones with TVs, radios, walkie-talkies and scanners. 274-361 1.99
- (6) **Accepts 1/4" Monaural Plug.** 274-047 1.29
- (7) **Accepts Phono Plug.** 274-330 1.69

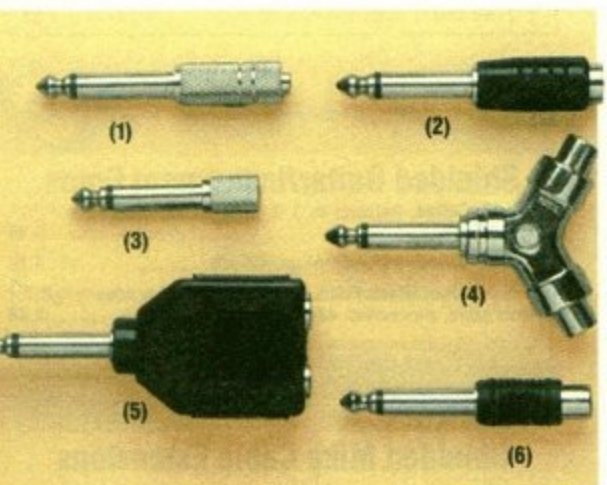

These Plug Into a 1/4" Monaural Jack

- (1) **Accepts 1/8" Stereo Plug.** Connect your lightweight stereo headphones to CB, Ham, shortwave and scanner radios, tape recorders and other monaural equipment. 274-348 1.99
 - (2) **Accepts 1/4" Stereo Plug.** Use full-size stereo headphones with CB, Ham, shortwave and scanner radios, tape recorders and other monaural equipment. 274-360 1.99
 - (3) **Accepts 1/8" Monaural Plug.** 274-325 1.59
 - (4) **Accepts Two Phono Plugs.** 274-304 1.99
 - (5) **Accepts Two 1/4" Plugs.** 274-309 2.99
 - (6) **Accepts Phono Plug.** 274-320 Pkg. of 2/2.79
- See previous page for our wide assortment of high-quality audio patch cables.

■ Gold plating for positive contact

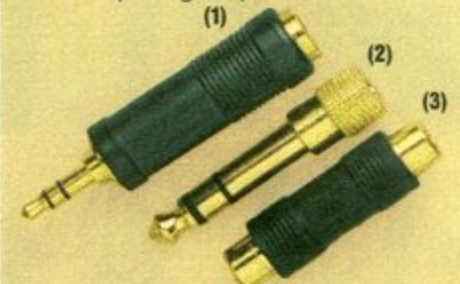

Adapters

- (1) **Accepts 1/4" Stereo Plug and Plugs into 1/8" Stereo Jack.** Use full-size headphones with a stereo that has an 1/8" headphone jack. 274-875, 2.99
- (2) **Accepts 1/8" Stereo Plug and Plugs into 1/4" Stereo Jack.** Connect "mini" 'phones to 1/4" jack. 274-876, 2.99
- (3) **Phono Plug Coupler.** Connects two phono plugs. 274-874 1.99



3/32" Submini Plug Adapters

Fig.	Accepts	Plugs Into	Cat. No.	Each
1	1/8" Stereo Plug	3/32" Stereo Jack	274-373	2.99
2	1/8" Stereo Plug	3/32" Mono Jack	274-381	1.99
3	1/8" Mono Plug	3/32" Mono Jack	274-327	1.29

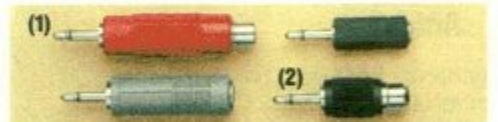

Record Attenuator and Adapter Set

- (1) **Recording-Level Attenuator.** Accepts phono plug and plugs into 1/8" monaural jack. Attenuator adapts line-level sources to a recorder's mike input. 274-300 2.79
- (2) **Three-Piece Monaural Adapter Set.** Adapts a phono plug, 1/4" phone plug and 3/32" submini plug to fit an 1/8" monaural jack. 274-359 Set 2.99

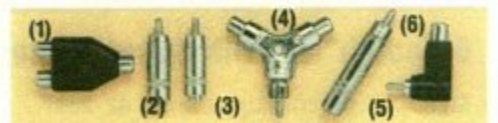

Phono Plug and Jack Adapters

Fig.	Plugs Into	Accepts	Cat. No.	Price
1	3 Phono Plugs (Y-Adapter)		274-511	2.49
2	Phono Jack	1/4" Stereo Plug	274-387	2.19
3	Phono Jack	1/4" Mono Plug	274-326	1.59
4	Phono Jack	Two Phono Plugs	274-303	1.99
5	Phono Jack	1/4" Mono Plug	274-389	2/2.99
6	Phono Jack	Phono Plug (90°)	274-306	2.39



Handy Plug-to-Plug Couplers

■ Easy way to join two cables

Fig.	Accepts	Cat. No.	Price
1	Two 1/4" Stereo Plugs	274-1556	2.39
2	Two 1/8" Stereo Plugs	274-1555	1.59
3	Two Phono Plugs	274-1553	2/1.39
4	4 Phono Plugs (2 Stereo Patches)	274-1548	4.99

get Gold

Plugs & connectors

■ Assures maximum signal transfer

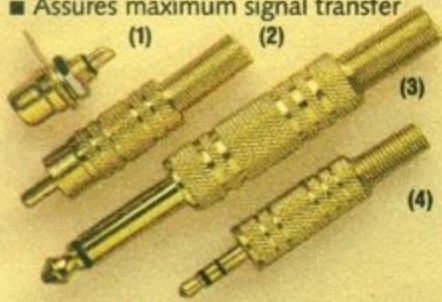

Connectors

- (1) Chassis-Mount Phono Jack. 1/4" mtg. hole. 274-852 .. Pkg. of 2/2.49
- (2) Phono Plug. Heavy-duty. Spring strain relief helps prevent damage to cable or jack. 274-850 2.49
- (3) Two-Conductor (Monaural) 1/4" (6.35mm) Phone Plug. 274-855, 3.49
- (4) Three-Conductor (Stereo) 1/4" (3.5mm) Phone Plug. 274-858, 3.49



Phono Plugs

- (1) Solderless 90°. 2 red and 2 black. 274-383, Set of 4/1.89
- (2) Solderless. Includes 2 red, 2 black. 274-384, Set of 4/1.79
- (3) Color-Coded. Solder-type. 274-321 Set of 8/2.19
- (4) With Plastic Grip-Style Covers. 274-319 ... Set of 4/1.79
- (5) Shielded, Solder-Type. 274-339 Pkg. of 2/1.59
- (6) Strain Relief. 3 black and 3 red. 274-451 ... Set of 6/1.99



Inline Phone Jacks

- (1) Two-Conductor 1/4". 274-340 .. Pkg. of 2/2.19
- (2) Three-Conductor 1/4". 274-141 ... Pkg. of 2/2.59
- (3) Three-Conductor 1/4". Shielded. 274-142 .. 2.99
- (4) Three-Conductor 1/8". 274-333 .. Pkg. of 2/1.69
- (5) Three-Conductor 1/8". 274-274 .. Pkg. of 2/1.79

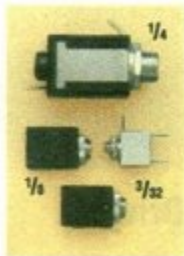

Enclosed Jacks

Open-Circuit Types			
Size	Cond.	Cat. No.	Price
1/4"	2	274-280	1.19
1/8"	3	274-249	2/1.59
Closed-Circuit Types			
Size	Cond.	Cat. No.	Price
3/32"	2	274-247	2/1.49
1/8"	3	274-246	1.59

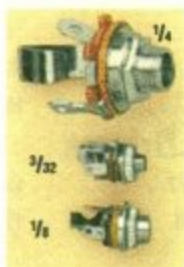

Open-Frame Jacks

Open-Circuit Types			
Size	Cond.	Cat. No.	Price
1/4"	2	274-252	2/1.79
1/4"	3	274-312	2/2.49
1/8"	2	274-251	3/1.59
Closed-Circuit Types			
Size	Cond.	Cat. No.	Price
1/4"	2	274-255	2/2.19
1/8"	2	274-248	2/1.79
3/32"	2	274-292	2/1.79

1/4", 1/8" and 3/32" Phone Plugs

- (1) Three-Conductor 1/4". (Stereo-type) (6.35mm). 1/2-dia. barrel. 274-139 Pkg. of 2/1.99
- (2) Three-Conductor 1/4". Shielded. 274-285 1.59
- (3) Three-Conductor 1/4". Has "grip" barrel and strain relief. Shielded. 274-1546 1.99
- (4) Two-Conductor 1/4". Mono. 274-1536 2/1.79
- (5) Two-Conductor "Big Barrel" 1/4". Screw terminals. 274-1539 Pkg. of 2/2.29
- (6) Two-Conductor 1/4". All-metal barrel. Shielded. 274-1544 2/2.99
- (7) Two-Conductor 1/4". Spring-coil strain relief. Shielded. 274-1545 1.79
- (8) Three-Conductor 1/4". Right-angle type. Shielded. 274-265 1.79
- (9) Two-Conductor 1/4". Right-angle type. Shielded. 274-254 Pkg. of 2/2.19
- (10) Three-Conductor 1/8". (3.5mm) mini-size. Solder terminals. 274-284 Pkg. of 2/2.19
- (11) Three-Conductor 1/8". Spring strain relief. Shielded. 274-1547 1.99
- Two-Conductor 1/8" Mini Size.
 - (12) Black. 274-286 Pkg. of 2/1.49
 - (13) Red. 274-287 Pkg. of 2/1.49
 - (14) Shielded. 274-288 Pkg. of 2/1.99
- Two-Conductor 3/32" (2.5mm) Submini Size.
 - (15) Black. 274-289 Pkg. of 2/1.49
 - (16) Red. 274-290 Pkg. of 2/1.49
 - (17) Heavy-Duty Two-Cond. 3/32". Shielded, with strain relief. 274-279 1.49

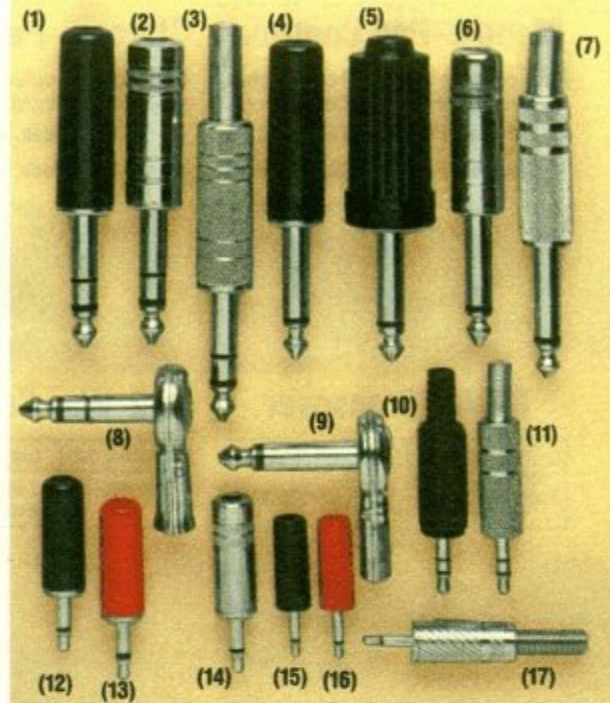

XLR-Type and Mike Connectors

- (1) Three-Pin XLR Plug. 274-010 2.99
- (2) Three-Pin XLR Inline Socket. 274-011 2.99
- (3) Three-Pin XLR Panel Socket. 274-013 3.69
- (4) Adapter/Transformer. Accepts XLR plug. Fits 1/4" jack. Connect mike with XLR plug to a recorder or amp that has a 1/4" input jack. 274-016 11.99
- (5) Adapter/Transformer. Accepts 1/4" plug. Fits XLR jack. Connect mike with 1/4" plug to equipment that has an XLR input jack. 274-017 11.99
- (6) Eight-Pin Ham Radio Mike Plug. 274-025 2.19
- (7) Four-Pin Panel-Mount Socket. 274-002 1.29
- (8) Four-Pin Plug. 274-001 1.69

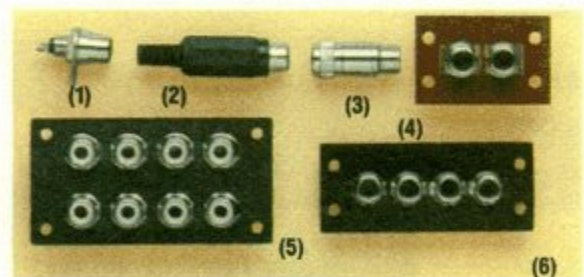

Phono Jacks and Phono Jack Boards

- (1) Panel-Mount. 1/4" mtg. hole. 274-346, Pkg. of 4/2.19
- (2) Plastic Inline. 274-337 Pkg. of 4/1.49
- (3) Shielded Inline. 274-338 Pkg. of 2/1.59
- (4) Dual Phono Jacks. Chassis-mount. Ideal for projects and repairing changers, tape decks, amplifiers and receivers. Each accepts two plugs. 274-332, Pkg. of 2/1.19
- (5) Eight-Position Phono Jack Board. 274-370 1.69
- (6) Four-Position Phono Jack Board. 274-322 1.29

Speaker Terminal Plates

- With Keyhole Slot. Makes it easy to hang a speaker on the wall. 274-627 2.19
- With Phono Jack. 274-625 1.99
- Two-Position Pushbutton Terminal. Spring action for positive contact. 274-315, 1.29
- Eight-Position Pushbutton Terminal. Spring action. 274-623 2.99
- Four-Position. 274-622 1.59
- Two-Position. 274-621 1.19

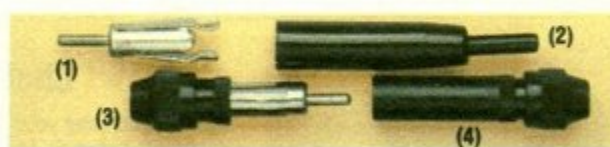

"Car Radio" Connectors

- (1) Motorola-Type Plugs. Fit many car radios and scanners. Solder type. 274-711 Pkg. of 2/99¢
- (2) Inline Jack Assembly. 6" cable. 274-713 1.39
- (3) Solderless Motorola-Type Plug. 274-709 1.39
- (4) Solderless Inline Jack. 274-710 1.39



Shielded DIN

Fig.	Type	Pins	Cat. No.	Each
1	Plug	5	274-003	1.69
1	Plug	6	274-020	1.79
1	Plug	8	274-026	1.79
2	Jack	5 or 3	274-006	1.69
2	Jack	8	274-027	1.99
(3) 5-Pin Jack. 274-005				99¢

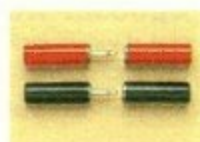

Plug and Inline Jack Set

- Two-Conductor (Monaural) 1/8" Set includes two mini-size plugs and two mini-size jacks. 274-283 4-Piece Set/2.49

Speakers...for new

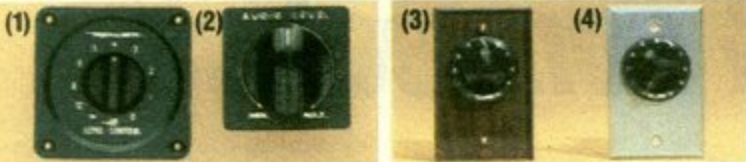

Mono L-Pad Controls

Each controls volume of one 8-ohm speaker. Mounts in wall or cabinet.

- (1) 75 Watt Peak. 40-977 ... 9.95
 (2) 25 Watt Peak. 40-980 ... 5.95

Stereo L-Pad Controls

Each controls volume of two 8-ohm speakers. Fit most std. wallboxes.

- (3) 75 Watt Peak. 40-978 .. 15.95
 (4) 25 Watt Peak. 40-979 ... 9.95

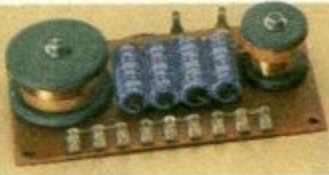

3-Way Crossover

Crossover (Hz)	Cutoff	Cat. No.	Each
800-5000/800-7000/1600-5000/1600-7000	6dB/octave	40-1299	14.95



2-Way Crossover

Crossover (Hz)	Cutoff	Cat. No.	Each
2000/2500/4000	6 dB/octave	40-1296	7.95



Wide-Range Speakers for Every Need

Fig.	Size	Cap. (W)	Eff. Range (Hz)	Magnet Wt. (Oz.)	Cat. No.	Each
1	3"	2.0	300-5000	0.4	40-248	3.39
	2 1/4"	0.5	240-4000	0.4	40-246	2.99
	2"	0.5	250-5000	0.4	40-245	2.59
2	6" with Whizzer	20	55-12,000	9.8	40-1285	16.95
	6"	5.0	90-12,000	2.8	40-1242	6.95
3	8"	10	75-25,000	2.8	40-1271	7.95
	8"	10	90-20,000	5.3	40-1272	10.95
	8"	30	57-16,000	9.4	40-1286	18.95



High-Quality Paper-Cone Woofers

Fig.	Size (In.)	Cap. (W)	Eff. Range (Hz)	F ₀ (Hz)	Q _{TS}	V _{AS} (ft. ³)	SPL 1W/1M	Cat. No.	Each
1	18"	200	25-1200	16.5	.20	41	95	40-1309	139.95
2	10"	50	40-5000	40	.93	4.3	91	40-1331	35.95
3	8"	50	45-2500	50	.58	1.4	91	40-1016	29.95
4	4"	10	55-5000	85	.47	.23	84	40-1022	13.95

Metal Speaker Grilles

With mounting screws.

- 15" Grille. 40-1358 16.95
 12" Grille. 40-1346 10.95
 10" Grille. 40-1357 8.95
 8" Grille. 40-1345 7.95

Ceiling Grilles

Round grilles with hardware. Great for use in reception areas.

- 8" Grille. 40-1223 5.69
 4" Grille. 40-1220 4.59



Speaker Grille Fabric

Fig.	Desc.	Size	Cat. No.	Each
1	Heavy Duty	36x32"	40-1952	7.95
2	Brown	36x34"	40-1936	7.95
3	Black	36x34"	40-1935	7.95

Foam Grille

Acoustically transparent. 17 x 23 1/2 x 3/4". Trim with scissors. **Brown, 40-1946. Black, 40-1951 .. Each 8.95**

New! Choke Coil

Ideal for building your own high-power crossover network. High linearity helps to reduce distortion. Capacity: 200 watts. Cutoff: 150 Hz at 4 ohms, 300 Hz at 8 ohms. 40-1326 13.95

Metal Wall Brackets

Easy way to wall-mount speakers and keep brackets hidden from view. Great for surround sound installations. Each supports up to 50 lbs. With screws and hardware for hardwood mounting of two speakers. 40-150 3.49

Acoustic Insulation

Easy to install. Fiber glass pad damps out unwanted effects in speaker enclosure. One square yard. 42-1082 3.49

Speaker Wall Jacks

Fit most standard wall boxes.

- (1) Two phono plugs. 40-981 ... 3.29
 (2) Two push-terminals. 40-975, 3.39

Tweeters



High-Power Piezo Tweeters With Ceramic Drivers

- (1) 2" Cone. 75 watts, 5-25 kHz. 93 dB (1W/1M). 40-1383 4.95
 (2) 3.5" Horn. 75 watts, 4-27 kHz. 94 dB (1W/1M). 40-1396 13.95
 (3) 2x6" Horn. 75 watts, 2-25 kHz. 94 dB (1W/1M). 40-1379 14.95
 (4) 3.75" Horn. 75 watts, 4-25 kHz. 92 dB (1W/1M). 40-1397 9.95
 (5) Rectangular. 85 watts, 4-27 kHz. 92 dB (1W/1M). 40-1398 10.95

High-Performance Tweeters With Dynamic Drivers

- (6) 4" Dual Radial Super Horn. 70 watts, 4-50 kHz. 90 dB (1W/1M). 40-1377 17.95
 (7) 1" Wide-Dispersion Dome. 40 watts, 6-20 kHz. 87 dB (1W/1M). 40-1276 17.95

or replacement use



High-Performance, Affordable Polypropylene Woofers

Fig.	Size (In.)	Cap. (W)	Eff. Range (Hz)	F ₀ (Hz)	Q _{TS}	V _{AS} (ft.)	SPL 1W/1M (db)	Cat. No.	Each
1	12"	50	40-3000	21.5	.665	15.5	89	40-1026	53.95
2	10"	50	35-3000	37	.554	4.0	92	40-1014	37.95
3	15"	100	30-1500	20	.45	21.0	92	40-1301	64.95
4	6 1/2"	50	50-6000	50	.40	1.5	89	40-1011	21.95
5	8"	50	40-3000	35	.48	2.1	89	40-1024	33.95

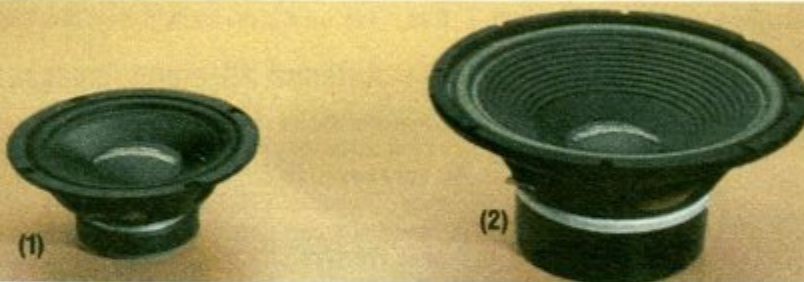

Dual-Coil Subwoofers for Bass You Can Feel

Fig.	Size (In.)	Magnet Wt. (Oz.)	Coil	Cap. (W)	Eff. Range (Hz)	F ₀ (Hz)	Q _{TS}	V _{AS} (ft.)	SPL 1W/1M	Cat. No.	Each
1	8"	18	Combined	100	40-1000	45	.48	1.7	86	40-1348	41.95
			Each	50	40-1000	45	.48	1.7	92		
2	12"	19	Combined	120	26-2700	21	.38	13.3	89	40-1350	61.95
			Each	60	26-2700	21	.38	13.3	95		

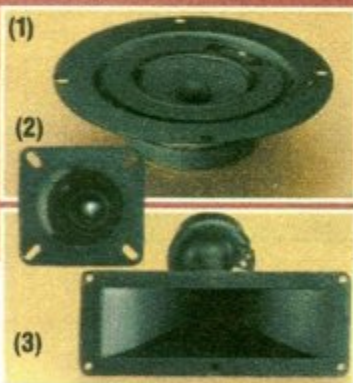

Dynamic Tweeters

Wide, controlled dispersion.

- (1) 1 3/4" Cone. 25 watts, 5-20 kHz. 91 dB (1W/1M). 40-1270 8.95
- (2) 2 1/4" Horn. 50 watts, 6-16 kHz. 98 dB (1W/1M). 40-1278 13.95
- (3) 2 x 6" Horn. 60 watts, 5-17 kHz. 96 dB (1W/1M). 40-1228 16.95

Midranges



Low Price, High Performance

- (1) This 4" midrange has a 2.8 oz. magnet, 1.5-11 kHz response and 40-watt capacity for improving mid-frequency response. 92 dB (1W/1M). 40-1282 11.95

Mid/Tweeter and Midrange

- (2) 3" Mid/Tweeter. 30 watts, 0.7-20 kHz. 89 dB (1W/1M). 3 oz. magnet. 40-1289 12.95
- (3) Soft-Dome 4" Midrange. 70 watts, 1.5-10 kHz. 86 dB (1W/1M). 10.8 oz. magnet. 40-1281 23.95

F.Y.I.

SPL/EFFICIENCY. Sound Pressure Level (SPL) measures how efficiently a speaker converts input power to sound. The decibel rating is derived by measuring the SPL of a 1-watt signal, on axis, 1 meter from the speaker. The higher this number is, the more efficient (and louder) the speaker will be.

DUAL-VOICE COIL (SUBWOOFERS). Allows both channels of a stereo amplifier to be routed into a single subwoofer, therefore reproducing the very low, nondirectional bass effects for both channels in a single subwoofer. Most stereo installations require only one subwoofer.

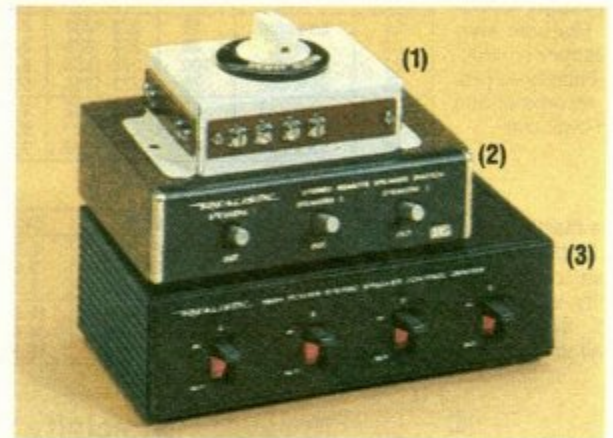

Speaker Selector Switches

- (1) **Four-Speaker Switch.** Lets you easily control two pairs of stereo speakers. Select pair-one, pair-two or both. Metal case with predrilled tabs and screw terminals. 40-130 8.95
- (2) **Six-Speaker Switch.** Control up to three pairs of speakers from one location. Rated at 10 watts per channel. Simulated-walnut finish. 40-125 17.95
- (3) **Eight-Speaker Switch.** For higher-powered amps and receivers. Spring-terminal connectors. Rated at 100 watts per channel. 40-136 31.95

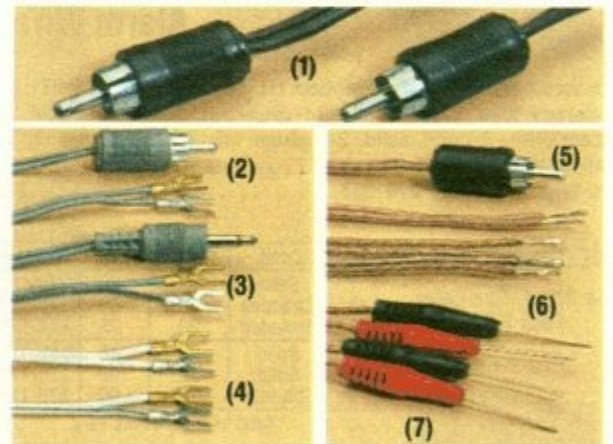

America's Source for Speaker Cables

(1) Cables with RCA-type plugs.

Feet	Color	Gauge	Cat. No.	Each
50	Brown	18	42-2480	8.99
24	Brown	18	42-2478	4.99
12	Brown	18	42-2479	3.99
24	Gray	24	42-2392	3.29
24	White	24	42-2430	3.29
12	Gray	24	42-2445	2.75
12	White	24	42-2431	2.75

- (2) **Plug-to-Lug Cables.** Phono plug.
24 Feet. 24 gauge. 42-2450 2.39
12 Feet. 24 gauge. 42-2449 2.25
- (3) **1/8" Plug-to-Lug.** 12 ft., 24 gauge. 42-2454 2.25
- (4) **Solderless Lug-to-Lug Cables.**
24 Feet. 24 gauge. 42-2446 2.19
12 Feet. 24 gauge. 42-2447 1.65
- (5) **Tinned Ends to Phono Plug.** 24 ft., 18 ga. 42-2457, 4.69
- (6) **Tinned Ends.** 24 feet, 18 gauge. 42-2456 4.29
- (7) **Pin Connector.** 24 feet, 18 gauge. 42-2455 4.99

The Shack® is the #1 source for all your wire and cable needs



Two-Conductor Speaker Wire

Clear Plastic Insulation. Features low-loss copper conductors. Polarity-keyed. Not recommended for in-wall use.

Gauge	Type	Feet	Cat. No.	Each
24	Stranded	50	278-1301	2.99
24	Solid	75	278-1509	3.49
22	Stranded	100	278-1385	5.49
20	Stranded	75	278-1388	5.99
18	Stranded	30	278-1602	3.99
18	Stranded	60	278-008	6.99
16	Stranded	50	278-1267	7.99

Brown Plastic Insulation. With stranded copper conductors. Polarity-keyed. UL listed. Suitable for in-wall use.

Gauge	Feet	Cat. No.	Each
20	30	278-1101	3.99
20	100	278-1102	9.99
18	30	278-1103	3.99
18	100	278-1104	11.99
16	30	278-1105	4.99
16	100	278-1106	15.99



Specialty Wire

- (1) **Magnet Wire Assortment.** For coil winding. Includes 40 feet of 22-gauge, 75 feet of 26-gauge and 200 feet of 30-ga. **278-1345, 4.99**
- (2) **Solid Bus Wire.** 24-gauge tinned copper. 50 feet. **278-1341, 1.79**
- (3) **Probe Wire.** 20-gauge stranded. UL 25 feet. **Red. 278-563, 2.99**
Black Probe Wire. 20-gauge stranded UL 25 ft. **278-564 2.99**



Intercom and Alarm Wire

- (1) **Intercom Wire.** 3-cond. stranded. UL listed. 50 feet. **278-871, 4.99**
- (2) **Intercom Wire.** 4-cond. solid. 24-gauge. UL 20 feet. **278-858, 3.49**
- Intercom Wire.** 2-cond. solid. 24-gauge. UL 35 feet. **278-857, 3.49**
- (3) **Alarm Wire.** 2-cond. stranded. 22-ga. UL 100 ft. **278-862 . . 7.99**
- Alarm Wire.** 300 feet. **278-863 21.99**

Hookup Wire

One Spool, One Color
Each 3.99



- Type AWM
 - UL Recognized
- Three Spools, 3 Colors
Each 4.49

Fig.	Cond.	Gauge	Feet*	Cat. No.
1	Solid	18	60	278-1217
2	Stranded	18	55	278-1220
2	Stranded	20	75	278-1219
1	Solid	20	80	278-1216
1	Solid	22	100	278-1215
2	Stranded	22	90	278-1218

*Total footage; colors vary.

Fig.	Cond.	Gauge	Feet*	Cat. No.
1	Solid	18	60	278-1223
2	Stranded	18	45	278-1226
2	Stranded	20	60	278-1225
1	Solid	20	75	278-1222
1	Solid	22	90	278-1221
2	Stranded	22	75	278-1224

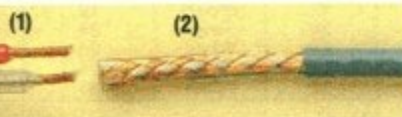

Shielded Mike and Audio Cable

- (1) **Balanced Mike Cable.** Two shielded conductors. 30-ft. **278-1281 19.95**
- (2) **Mini Mike Cable.** UL listed. 30 feet. **278-510 4.99**
- Heavy-Duty Mike Cable.** UL listed. 40 feet. **278-511 8.99**
- Audio Cable.** Great for building patch cords. UL listed. 20 feet. **278-512 3.49**
- 2-Conductor Audio Cable.** UL listed. 50 feet. **278-513 . . 6.95**
- 2-Conductor Audio Case.** UL listed. 20 feet. **278-514 . . 3.49**

Wire and cable

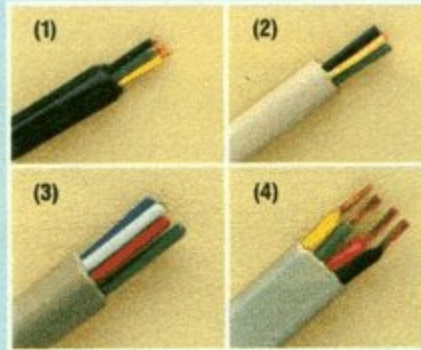

Telephone Cable and Cord

- (1) **Indoor/Outdoor.** Rugged 4-conductor cable. 24-gauge solid. UL 250 ft. **278-386 34.99**
NEW! 100-Ft. Indoor/Outdoor Telephone Wire. **278-385, 14.99**
- (2) **Four-Conductor.** 24-gauge solid. UL listed. 50 Feet. **278-872 6.49** 100 Feet. **278-873 11.99**
Bulk. **278-1310 Price Per Foot/13¢**
- (3) **Six-Conductor.** 24-gauge solid. UL listed. 100 feet. **278-874 14.99**
- (4) **Modular Phone Cord.** 4-conductor stranded. 50 Feet. **278-365 5.99** 100 Feet. **278-366 11.99**

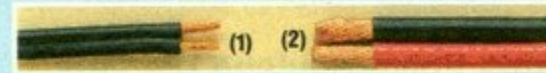

UL Listed Lamp Cord

- (1) 100 feet, 2-conductor stranded cord. **SPT-1.** 18-gauge. **278-1430 14.99**
SPT-2. 16-gauge. **278-1440 21.95**

Heavy-Duty Utility Wire

- (2) **Automotive Wire.** 10-gauge. 35 feet. **Red. 278-568 11.95** **Black. 278-569 11.95**
- 12-Gauge Wire.** Stranded. UL listed. 20 feet. **Red. 278-565 3.99** **Black. 278-566 3.99**
- 2-Cond.** 25-ft. stranded. 18-ga. UL. **278-567 . . 3.99**

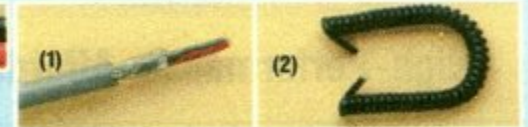

Double-Shielded 4-Cond. Wire

- (1) For data and audio. Very high quality cable with 100% foil wrap plus 75% braided shield. 30 feet. **278-777 7.95**

Coiled Mike Cable

- (2) Premium quality at low cost! Ideal for replacing CB, Ham and marine radio mike cords. Four conductors (one is shielded). 5 feet. **278-356 2.99**

Antenna Wire and Accessories

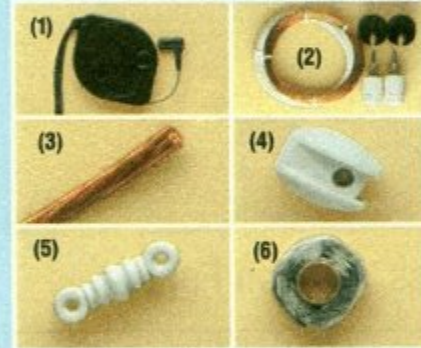

- (1) **Portable Shortwave Antenna.** DX grabber! Clips over rod antenna. 23 ft., compact travel/storage reel. **278-1374 . . 8.95**
- (2) **SW Antenna Kit.** 75-ft. wire, 50 ft. lead-in, window feed-through, insulators. **278-758 8.49**
- (3) **Antenna Wire.** 70 ft. of extra-strong 14-gauge, 7-strand copper. **278-1329 5.99**
- (4) **Mini-Egg Insulators.** 278-1335 Pkg. of 2/2.99
- (5) **"Dogbone" Insulator.** 3 1/2". **278-1336 1.99**
- (6) **Outdoor RF Connector Sealant.** Keeps moisture out of hookups. 60" roll. **278-1645 2.49**



Archer® Shielded Coax Cable

■ Made in the USA by us!
Now an even better value!
Ideal for amateur radio, CB, scanner,
TV and FM radio hookups. UL listed.

RG Type	Ohms	OD (in.)	Velocity Factor	Loss in dB Per 100 Feet	Cap. Per Feet	Center Cond.	Cat. No.	Per Ft.
8	52	.405	66%	100 MHz: 1.9 400 MHz: 4.1	26.4 pF	13# 7x21	278-1312	.49
8/M	51	.242	78%	100 MHz: 3.7 400 MHz: 8.0	25.2 pF	16# 19x29	278-1313	.28
58	53	.196	66%	100 MHz: 4.5 400 MHz: 10.0	28.5 pF	20# Solid	278-1314	.20
59+	80	.242	78%	100 MHz: 2.9 400 MHz: 5.9	15.6 pF	22# Solid	278-1315	.20
6	75	.266	78%	100 MHz: 2.2 400 MHz: 4.4	17.5 pF	18# Solid	278-1316	.20
6QS	75	.286	78%	100 MHz: 2.1 400 MHz: 4.4	17.3 pF	18# Solid	278-1317	.31



Ready-to-Use 52 and 75-Ohm RF Cable Assemblies

- (1) **6-Foot BNC to BNC.** For test instrument and RF hookups. 52-ohm. **278-964 5.99**
NEW! **12-Foot BNC to BNC.** RF cable for test instruments. 52-ohm. **278-965 9.99**
- (2) **3-Foot Cellular Phone Extension.** Male TNC to female TNC. 52-ohm. **278-976 4.99**
- (3) **2-Foot RG-58 Patch.** PL-259 at each end. 52-ohm. **278-968 4.99**
- 20-Foot RG-58.** PL-259 at each end. 52-ohm. **278-967 6.99**
- 50-Foot RG-58.** PL-259 at each end. 52-ohm. **278-971 13.99**
- (4) **10-Foot RG-8/M Patch.** PL-259 at each end. 52-ohm. **278-979 7.99**
- (5) **5-Foot RG-8 Patch.** PL-259 at each end. 52-ohm. **278-969 6.49**
- (6) **50-Foot RG-8 Patch.** PL-259 at each end. 52-ohm. **278-980 32.99**
- (7) **6-Foot RG-58 Extension.** PL-259 to SO-239. 52-ohm. **278-975 5.29**
- (8) **20-Foot Mobile Antenna Harness.** PL-259 to spades. 52-ohm. **278-966 6.99**
- (9) **NEW!** **6-Foot RG-59 75-Ohm Cable.** BNC to BNC RF cable. **278-990 5.99**

Wire management

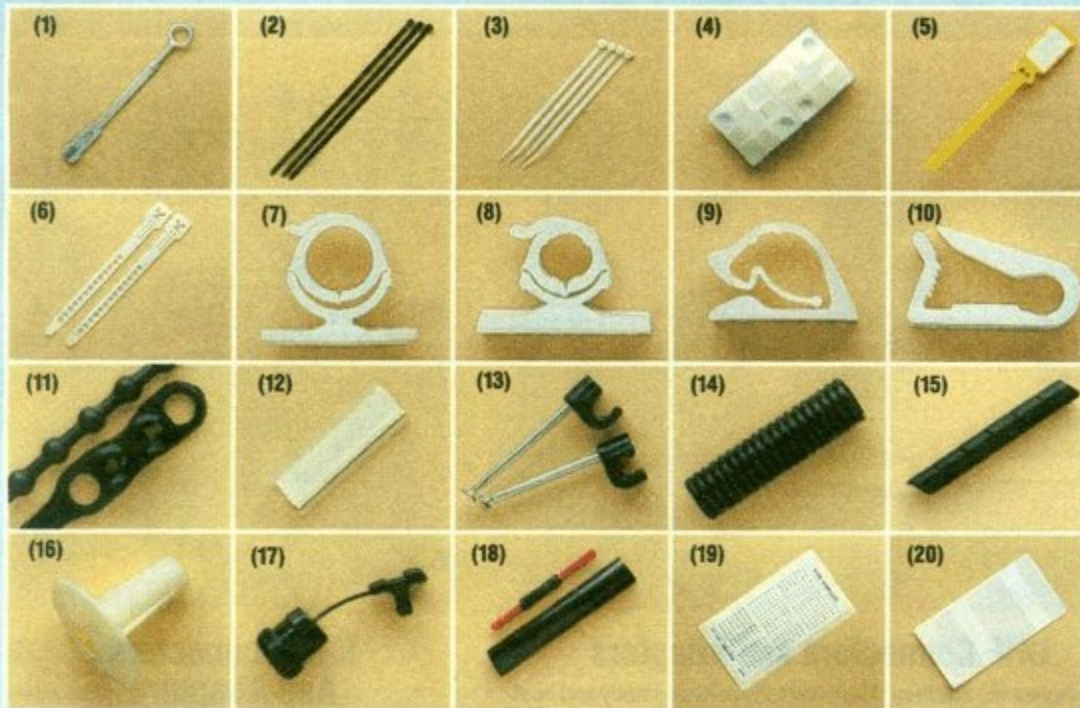

Everything You Need to Make a Wiring Job Easier

- (1) **Reusable Cable Ties.** Bundle together cables. Accept bundle up to 1 3/8" diameter. Hang-up loop. 278-1622 Pkg. of 10/4.99
- (2) **Indoor/Outdoor Nylon Wire Ties.** 8" long. Ultra-violet (UV) stabilized for long outdoor life. 278-1652 Pkg. of 30/2.99
- NEW!** 12 1/2" Version of Fig. 2. 278-1655, Pkg. of 30/4.99
- (3) **4" Wire Ties.** Unbreakable nylon. Self-locking. 278-1632 Pkg. of 30/1.59
- 5" Wire Ties.** 278-1631 Pkg. of 30/1.99
- 8" Wire Ties.** 278-1642 Pkg. of 30/2.99
- (4) **Wire-Ties Mounts.** Adhesive backed. 3/4 x 3/4". 278-441 Pkg. of 10/1.59
- (5) **Cable Tie/Marker.** For cables up to 5/8" diameter. 278-1648 Pkg. of 10/2.49
- (6) **AC Cord Ties.** 278-1646 Pkg. of 6/99¢

Fig.	Type	Accepts Cable	Cat. No.	Pkg.	Price of
7	Jumbo	5/8"	278-1641	3	1.79
8	Standard	3/8"	278-1640	10	2.69
9	Adjustable	1/2"	278-1639	10	2.49
10	Universal	3/8"	278-1647	10	2.79

- (11) **Beaded Wire Ties.** Adjustable and reusable. UV stabilized—ideal for outdoor use. 6 7/16" long. 278-1619 Pkg. of 10/99¢
- (12) **Self-Stick Wire Clips.** Holds most household speaker, power and modular phone wires. For indoor use. 278-1618 Pkg. of 12/1.99
- (13) **Nail-In Coax Clips.** Slip over cable. For RG-58 Cable. 20-192 Pkg. of 10/99¢
For RG-8 Cable. 20-193 Pkg. of 6/99¢
- (14) **Split Loom Tubing.** Gathers wires into a bundle. 5 ft., 1/2" diameter. 278-1624 3.99
- NEW!** 3/4" Diameter Split Loom Tubing. 5 feet. 278-1654 4.99
- (15) **Spiral Wrap.** 10 feet. 278-1638 1.99
- (16) **Wall Feedthrough Bushing for Coax.** For RG-6, 8M. 278-1644 Pkg. of 2/49¢
For 59, 58, 62. 278-1643 Pkg. of 2/49¢
- (17) **Strain Reliefs.** For cable-entry point on chassis or enclosure. 278-1636 6/79¢
- (18) **Heat Shrink Tubing.** 1/16" to 1/2" sizes. UL listed. 278-1627 Pkg. of 7/1.79
- (19) **Wire Markers.** Total of 630 "peel 'n stick" letters, numbers. 278-1650 Set 1.79
- (20) **NEW!** Self-Laminating Cable Markers. 278-1616 Pkg. of 24/1.99

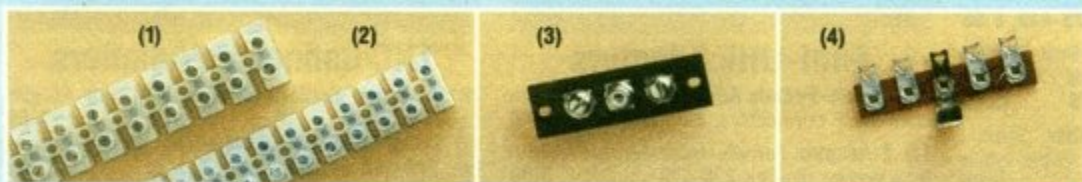

Do it Right With Wire Terminal Strips

- (1) **12-Position "Jumbo" Euro-Style Barrier Strip.** 274-677 3.99
- (2) **12-Position Terminal.** 274-679 2.29
- 8-Position Terminal.** 274-678 1.89

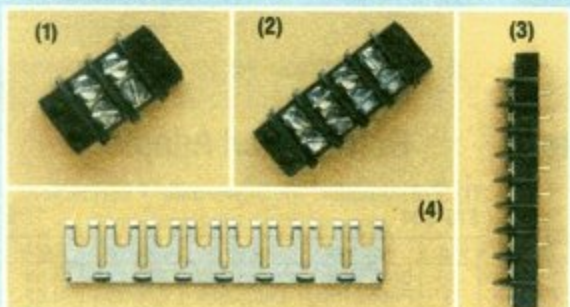

- (3) **Screw Terminals With Phono Jack.** Ideal for replacing isolated jacks for speakers, TV antenna input/output and radios. 274-620 Pkg. of 2/1.59
- (4) **Five-Lug Tie Points.** Use center lug for grounding. 274-688 Pkg. of 4/1.29

Barrier Strips and Accessories

- (1) **2-Position.** Heavy duty. Barriers help prevent accidental contact and short circuits. 274-656 Pkg. of 2/1.49
- (2) **4-Position.** 274-658 Each 1.49
- 6-Position.** 274-659 Each 1.59
- 8-Position.** 274-670 Each 2.19
- (3) **Chassis-Mount Feedthrough Barrier Strip.** Eight positions. 274-653 2.59
- (4) **8-Position Jumper.** 274-650 1.59

Let Radio Shack's
gadgets help you
do the best wiring job

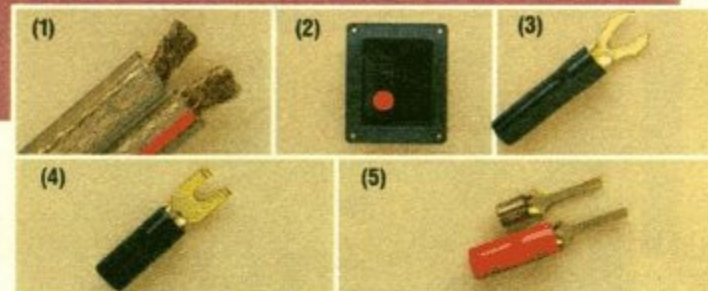

MEGACABLE and Accessories

- (1) **MEGACABLE® Speaker Wire.** Our best! Massive 12-gauge braided pure copper conductors and deluxe insulation. Increases your amplifier's efficiency. 278-1268 Per Foot 99¢
- (2) **NEW!** MEGACABLE Speaker Plate. Recessed terminals accept larger speaker wires. 274-630 2.99
- (3) **Gold-Plated Connectors.** Four red, four black. 64-401, Set of 8/5.19
- (4) **Smaller Version of Above.** 64-402 Set of 8/4.69
- (5) **Gold-Plated Pin-Type Connectors.** 64-403 Set of 4/3.29



Polarized Interlocking Connectors

Heavy-Duty

Male. 250V Per Circuit

Female. 250V Per Circuit

Pos.	Amps	Cat. No.	Each
2	20	274-151	.99
6	15	274-152	1.69

Pos.	Amps	Cat. No.	Each
2	20	274-154	.99
6	15	274-155	1.69

Standard

Male. 125V Per Circuit

Female. 125V Per Circuit

Pos.	Amps	Cat. No.	Each
4	9	274-224	1.09
6	9	274-226	1.39
9	9	274-229	1.59
12	7.5	274-232	1.69

Pos.	Amps	Cat. No.	Each
4	9	274-234	1.09
6	9	274-236	1.39
9	9	274-239	1.59
12	7.5	274-242	1.69

- Two-Pin Male/Female Set.** Up to 12 amps, 250VAC per circuit. 274-222 Set 99¢

Pin Extractor

Male/female standard/polarized removes easily without damage. .093" dia. locking crimp pins. 274-223 .. 4.99



DC Power Connectors

- (1) **Plugs.** Fit DC jack of many portables.

O.D.	I.D.	Cat. No.	Pkg. of 2
3.5mm	1.1mm	274-1574	1.69
3.5mm	1.3mm	274-1571	1.69
5.0mm	1.6mm	274-1570	1.29
5.0mm	2.1mm	274-1567	1.29
5.0mm	2.5mm	274-1568	1.29
5.5mm	2.1mm	274-1569	1.29
5.5mm	2.5mm	274-1573	1.29
6.3mm	3.0mm	274-1572	1.49

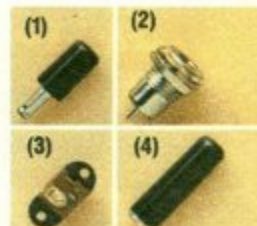

- (2) **Metal Panel-Mount DC Power Jack.** 5.5mm outside diameter, 2.1mm I.D. 274-1563 1.59
- 5.5mm O.D., 2.5mm I.D.** 274-1576 1.59
- (3) **Molded Power Jacks.** 5.0mm O.D., 2.1mm I.D. 274-1565, 2/1.29
- (4) **Inline Jacks.** 5.5mm O.D. 2.1mm I.D., 274-1577. Inline Jack. 2.5mm I.D. 274-1578 Each 1.79

Polarized Connectors

Rated 7.5A, 500V maximum per position.

Type	Positions	Cat. No.	Each
Plug	2	274-201	2.19
Socket	2	274-202	2.39
Plug	4	274-204	2.19
Socket	4	274-205	2.39



Better RF hookups begin at Radio Shack



75-Ohm Connectors for TV, VCR, FM

- (1) QS-56. For RG6QS quad-shield cable. 278-232, Pkg. of 2/99¢
- (2) Gold-Plated CF-59. For RG-59 cable. 278-224, Pkg. of 2/1.99
- (3) Gold-Plated CF-56. For RG-6 cable. 278-225 Pkg. of 2/1.99
- (3) Twist-On CF-59. For RG-59 cable. 278-227 59¢
- (4) Twist-On CF-56. For RG-6 cable. 278-228 59¢
- (4) **NEW!** Gold-Plated Twist-On CF56. For RG-6. 278-229 79¢
- (5) Standard CF-59. For RG-59 cable. 278-222 Pkg. of 2/99¢
- (5) Standard CF-56. For RG-6 cable. 278-223 Pkg. of 2/99¢
- (6) 10-Pak CF-59s. 278-230, 3.99 10-Pak CF-56s. 278-231, 3.99
- (6) F-59. For RG-59 cable. 278-211 Pkg. of 2/99¢
- (6) F-56. For RG-6 cable. 278-214 Pkg. of 2/99¢
- (7) F-56 Crimp Rings. 278-217, 6/59¢ F-59 Rings. 278-216, 6/59¢
- (8) Solderless F-59. For RG-59 cable. 278-215 99¢
- (9) F-61. Chassis-mount F jack. 278-212 Pkg. of 2/99¢
- (10) F-81 Coupler. Joins two F connectors. 278-213 99¢
- (11) Screw-On to Push-On Adapter. 278-218 1.49
- (12) Indoor 75-Ohm Cable Splicers. 278-226 Pkg. of 2/2.99
- (13) F Male-to-Male Adapter. 278-219 1.29
- (14) F Inline Right-Angle Adapter. 278-221 1.29

Fig.	Accepts	Fits	Cat. No.	Each
15	BNC Plug	F Jack	278-256	2.49
16	Phono Jack	F Jack	278-253	1.99
17	Phono Plug	F Jack	278-255	1.29

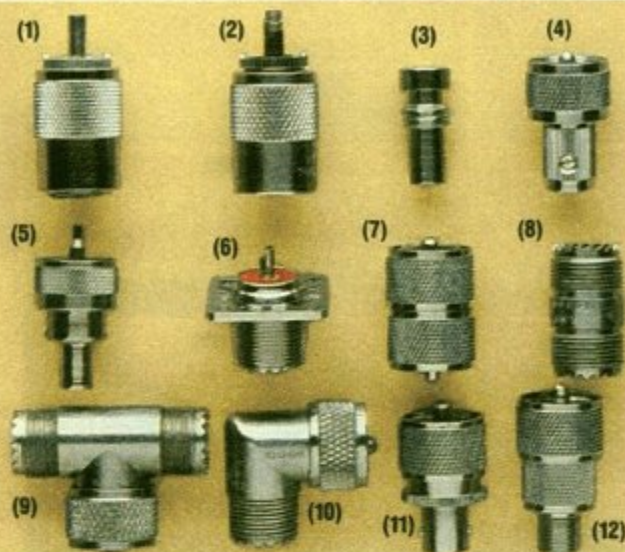

UHF Connectors and Adapters

- (1) Premium PL-259 Plug. The finest! Silver-plated body and heat-withstanding, low-loss Teflon™ insulator. 278-188 3.49
- (2) Standard PL-259 Plugs. 278-205 Pkg. of 2/2.79
- (3) UG-176 Reducers. Use to install PL-259 plugs on RG-59 and RG-8M cables. 278-204 Pkg. of 2/99¢
- (3) UG-175 Reducers. For RG-58 cable. 278-206 Pkg. of 2/99¢
- (4) No-Crimp Solderless PL-259 Plug. For RG-58 cable. Installs with a flat-blade screwdriver. 278-186 3.29
- (5) Solderless PL-259. For RG-58. 278-196 Pkg. of 2/2.19
- (5) Above for RG-59 and RG-8M. 278-191 Pkg. of 2/2.19
- (6) SO-239 Chassis-Mount Socket. 278-201 1.49
- (7) Double PL-259. Joins two SO-239s. Useful for low-pass filter and other accessory hookups. 278-192 2.19
- (8) PL-258 Coupler. Joins two PL-259 plugs. 278-1369 1.69
- (9) M-348 T-Adapter. Two SO-239 sockets to a PL-259 plug. Useful in beam antenna phasing lines. 278-198 3.49
- (10) M-359 Inline Right-Angle Adapter. Use when space is tight. Helps prevent damage to cable and jack. 278-199 2.49

Fig.	Accepts	Fits	Cat. No.	Each
11	BNC Plug	SO-239	278-121	2.59
12	Male F	SO-239	278-258	2.99

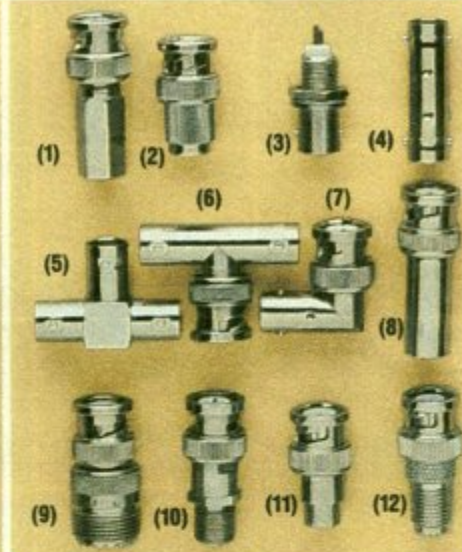

BNC Connectors And Adapters

- (1) Twist-On Male BNC Connector. For RG-58 cable. 278-103 2.99
- (1) Above for RG-59, RG-62. 278-104 2.99
- (2) No-Crimp Solderless BNC Male. For RG-58. 278-185 3.59
- (3) Type 1094 BNC Chassis-Mount Jack. 278-105 1.39
- (4) Type UG-306 BNC Female-to-Female Coupler. 278-115 1.99
- (5) BNC T-Adapter. Has female-female-female configuration. 278-111 3.99
- (6) BNC T-Adapter. Has female-male-female configuration. 278-112 3.19
- (7) Right-Angle Adapter. 278-116 3.99

Fig.	Accepts Plug	Fits Socket	Cat. No.	Each
8	Motorola	BNC	278-117	2.99
9	PL-259	BNC	278-120	2.49
10	F Male	BNC	278-251	1.99
11	Phono	BNC	278-254	2.49
12	Mini UHF	BNC	278-177	2.99

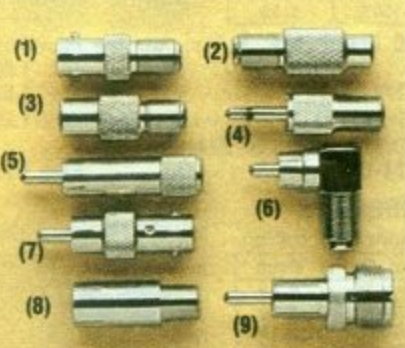
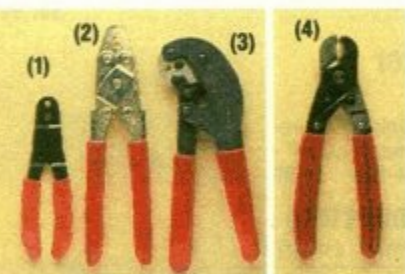

Crimp and Stripping Tools

- (1) Economy Crimping Tool. For F-type connectors. (Not for use with Radio Shack #278-222/223/224/225 and 278-230/231/232 connectors). 278-220 2.79
- (2) Med.-Duty Crimp Tool. 278-242, 6.95
- (3) "Pro" Crimping Tool. Our best. For our #278-222/223/224/225 and 278-230/231/232 connectors. 278-243 15.95
- (4) Precision Coax Cable Cutter. Special curved blades do not flatten cable while cutting. 278-244 5.95
- (5) Coax Stripper. Adjustable blades. For 3/16" to 5/16" dia. cables. 278-240, 12.95

Hard-to-Find Adapters

- (1) Accepts Male F and Male BNC. 278-264, 1.99
- (2) Accepts Male F & Phono Plug. 278-263, 1.49
- (3) European-TV Adapter. Accepts male F. Fits PAL TV antenna jack. 278-261 1.19
- (4) Accepts Male F. Fits 1/8" jack. 278-257, 1.99
- (5) Twist-On Phono Plug. 278-189 2.79
- (6) Accepts Male F. Fits phono jack. Right-angle type. 278-260 1.99
- (7) Accepts BNC Plug. Fits phono jack. 278-250 2.49
- (8) **NEW!** European-TV Adapter. Accepts male F connector. Fits PAL male. 278-265 1.49
- (9) "Scanner" Adapter. Accepts a PL-259 plug. Fits Motorola-type jack. 278-208 1.79



Mini-UHF Adapters

- (1) Double-Female Adapter. Joins two male mini-UHF connectors. 278-172 2.49
- (2) T-Adapter. Female-male-female. Useful as a power divider. 278-173 3.99

Fig.	Accepts	Fits Mini-UHF	Cat. No.	Each
3	PL-259	Female	278-174	3.99
4	BNC Male	Female	278-176	2.99
5	TNC Male	Female	278-146	2.99

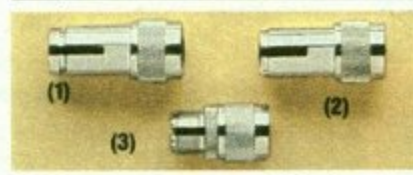

N Connectors and Adapters

- (1) Male N. For RG-8 cable. 278-149 3.49
- (2) Male N. For RG-58 cable. 278-151 3.49
- (3) PL-259 Adapter. Accepts PL-259 plug. Fits N jack. 278-156 4.49



TNC Connector/Adapters

- (1) No-Crimp Solderless Male TNC. For RG-58 cable. 278-184 3.59
- (2) Twist-On Male TNC Connector. For RG-58 cable. 278-140 1.99
- (3) Push-On Adapter. Converts a screw-on TNC male to push-on type. 278-133 3.99
- (4) Double-Female TNC. 278-142 1.99
- (5) Adapter. Accepts PL-259 plug. Fits female TNC. 278-118 3.49

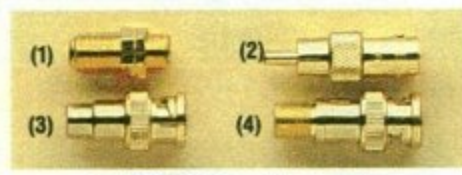

Gold-Plated Adapters

- (1) F-81 Coupler. Joins two male F connectors. 278-304 1.79

Fig.	Accepts	Fits	Cat. No.	Each
2	BNC Male	Phono Jack	278-301	3.99
3	Phono Plug	BNC Jack	278-303	3.99
4	F Male	BNC Jack	278-302	4.99

F.Y.I.

WIDE SELECTION. Radio Shack offers more than 50 different switches for hobby projects and repair work. Our big buying power means that prices are typically much lower than you'd pay elsewhere for identical quality. And at Radio Shack, you can see the switch before you buy it.

SPST. Single-Pole, Single-Throw switches have two terminals (hookup points). Switch one circuit on/off.
SPDT. Single-Pole, Double-Throw have three terminals. They switch one of the terminals, usually the middle one, between the two outside terminals.
DPDT. Double-Pole, Double-Throw. Six terminals. Switch two middle terminals between outside pairs.
NORMALLY OPEN switches are "on" while you are pushing button or lever. Example: doorbell button.
NORMALLY CLOSED. Breaks circuit while you push.
RATINGS. Important! See note at bottom of page.

We're the store with the switch you need

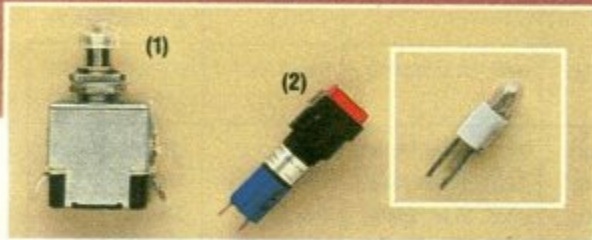

Illuminated AC Switches

- (1) Lighted 125VAC SPST Push On-Push Off. Heavy-duty 10-amp rating. For 125VAC use only. Button lights when the switch is "on". $7/8$ "-diameter stem. 275-671 3.99
- (2) Lighted 125VAC SPDT Push On/Push Off. Rated 3 amps at 125VAC. Has a preinstalled, replaceable lamp that requires 12 volts AC or DC. $7/8$ "-diameter stem. 275-676 6.49
- Replacement Bulb for Fig. 2. "Bi-pin" type miniature 12-volt lamp is designed for long life. 272-1154 1.29



Push On/Off and Momentary-Type Switches

- (3) SPST Push On/Off. Rated 3 amps at 250VAC. $1/2$ "-diameter stem. 275-011 1.39
- Momentary. Normally open. 275-609 Pkg. of 2/1.79
- (4) SPST Push On/Off. Rated 3 amps at 250VAC. $1/2$ "-diameter stem. 275-617 1.69
- Momentary. Normally open. 275-618 1.59
- (5) SPST "Soft-Feel" Push On/Off. Rated 3 amps at 125VAC. $3/8$ "-diameter stem. 275-1565 1.99
- Momentary. Normally open. 275-1566 1.89
- (6) SPST Momentary. Normally open. Rated 0.5 amp at 125VAC. $3/8$ "-diameter stem. 275-1571 Pkg. of 2/2.39

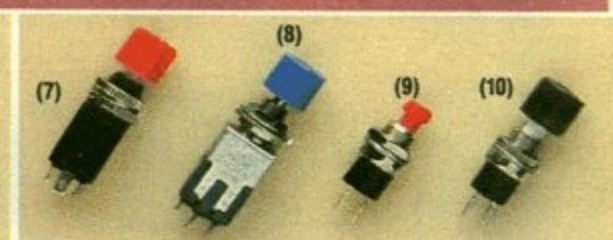

- (7) Mini SPDT Push On/Off. Rated 3 amps at 125VAC. $5/16$ "-diameter stem. 275-1555 2.49
- (8) Mini SPDT Momentary Pushbutton. Rated 3 amps at 125VAC. $1/4$ "-diameter stem. 275-1549 2.59
- (9) Mini SPST Momentary. Normally open. Rated 0.5 amp at 125VAC. $1/4$ "-diameter stem. 275-1547, Pkg. of 4/2.69
- Normally Closed Version of Fig. 9. 275-1548 Pkg. of 4/2.89
- (10) SPST Mini Momentary Pushbutton. Rated 3 amps at 125VAC and has a $1/4$ "-diameter stem. 275-1556 1.99

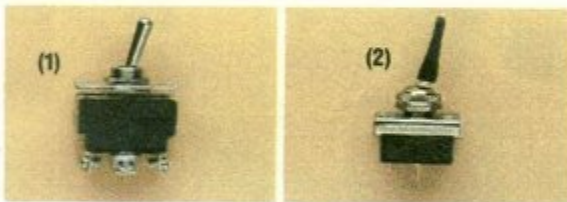

Heavy-Duty Toggle Switches

- (1) DPDT With Center Off Position. One of our most popular switches, year after year. Rated 10 amps at 125VAC. Features screw terminals for easy hookup (and easy disconnection in projects). Includes on-off-on label plate. $7/8$ "-diameter stem. 275-1533 1.89
- (2) Flat Lever. Rated 6 amps at 250VAC. Has $3/8 \times 1$ " lever and a $7/16$ "-diameter stem. UL listed.
- SPST. 275-651 1.99
- DPDT. 275-652 2.49
- SPDT With Center Off Position. 275-654 2.39
- DPDT With Center Off Position. 275-653 2.69
- (3) SPDT. Rated 5 amps at 125VAC. Has a $7/16$ "-diameter stem. 275-603 1.59

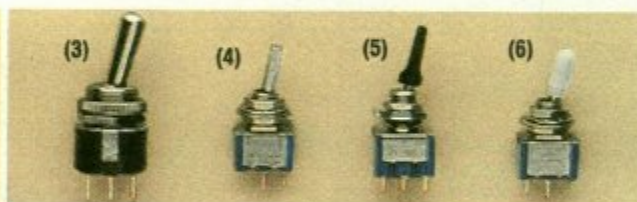

Miniature Toggle Switches

- (4) Flat Lever. Rated 6 amps at 125VAC. $1/4$ "-dia. stem.
- SPST. 275-634 2.69 SPDT. 275-635 2.89
- DPDT. 275-636 3.39
- DPDT Momentary. 275-637 3.69
- (5) Mini. Rated 6 amps at 125VAC. $1/4$ "-diameter stem.
- DPDT. 275-663 3.59
- DPDT With Center Off Position. 275-664 3.79
- (6) Hi-Current Mini. 10 amps at 125VAC. $1/4$ "-dia. stem.
- SPST. 275-324 2.89 SPDT. 275-326 2.99
- SPDT With Center Off Position. 275-325 3.39
- DPDT. 275-1546 3.59
- DPDT With Center Off Position. 275-1545 3.79



Submini and Micro-Size Toggles

- (7) Micromini. 3 amps at 125VAC. $1/4$ "-diameter stem.
- SPST. 275-624 2.29 SPDT. 275-625 2.39
- DPDT. 275-626 2.59
- (8) Submini. Rated 3 amps at 125VAC. $1/4$ "-diameter stem.
- SPST. 275-612 2.49 SPDT. 275-613 2.59
- DPDT. 275-614 2.99
- DPDT With Center Off Position. 275-620 3.19
- (9) SPDT Momentary. Rated 6 amps at 125VAC. Spring return to one position. $1/4$ "-diameter stem. 275-619, 2.39
- (10) PC-Mountable Submini SPST. Rated 0.3 amps at 125VAC. $1/4$ "-diameter stem. 275-645 1.99

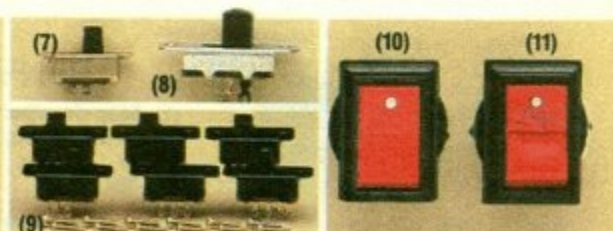
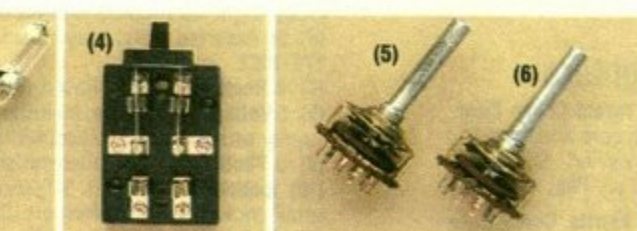
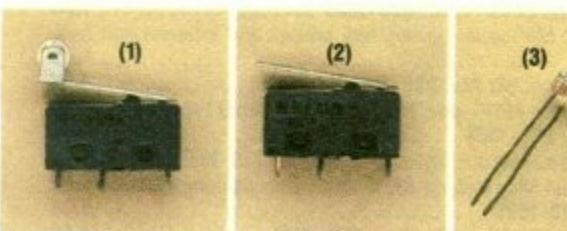

Our Wide Selection Also Includes Lever, Mercury, Knife, Rotary, Slide and Rocker-Type Switches

- (1) SPDT With $3/4$ " Roller Lever. Operating force: 5 grams. Rated 5 amps at 250VAC. Body size: $3/4 \times 1/4 \times 3/8$ ". UL listed. 275-017 1.79
- (2) SPDT With $3/4$ " Lever. Rated 5 amps at 250VAC. 275-016 1.69
- (3) Mercury Bulb. Just the thing for motion detectors and position sensing. Rated 2 amps at 12VDC. Compact T-1 $1/2$ envelope. 275-040 1.29
- (4) DPDT Knife-Type. Screw terminals. Many low-power uses including model railroads, hobby projects, antenna switching. Rated 0.5A at 250VDC. $1 5/8 \times 2 3/8 \times 3/4$ ". 275-1537 1.29
- (5) Rotary 2-Pole, 6-Position. Nonshorting. 0.3 amp at 125VAC. 275-1386 1.39
- (6) Rotary 1-Pole, 12-Position. Shorting. Rated as Fig. 5. 275-1385 1.39
- (7) SPST Submini Slides. Rated 0.3 amp at 125VAC. 275-406 Pkg. of 2/79c
- DPDT Submini Slides. Rated 0.3 amp at 125VAC. 275-407 Pkg. of 2/89c
- (8) SPST Heavy-Duty Slides. Rated 3 amps at 125VAC. 275-401 Pkg. of 2/1.19
- DPDT Heavy-Duty Slides. Rated 3 amps at 125VAC. 275-403 Pkg. of 2/1.39
- (9) Six-Piece Slide Switch Kit. Rated 0.5 amp at 125VAC. Includes one SPDT, one DPST, two DPDT and two SPST. Includes 12 mounting screws. 275-327 Set of 6/1.99
- (10) SPST Heavy-Duty Rocker. Rated 6 amps at 125VAC. $3/4$ "-dia. stem. 275-690 .. 1.99
- (11) DPDT Heavy-Duty Rocker. Rated 6 amps at 125VAC. $3/4$ "-diameter stem. 275-691, 2.59

NOTE: Always select a switch with the SAME or HIGHER voltage and current ratings as the voltage and current in the circuit where the switch is to be used. NEVER substitute a switch with a lower rating.

Relays

Radio Shack® is America's nearby source for hobby

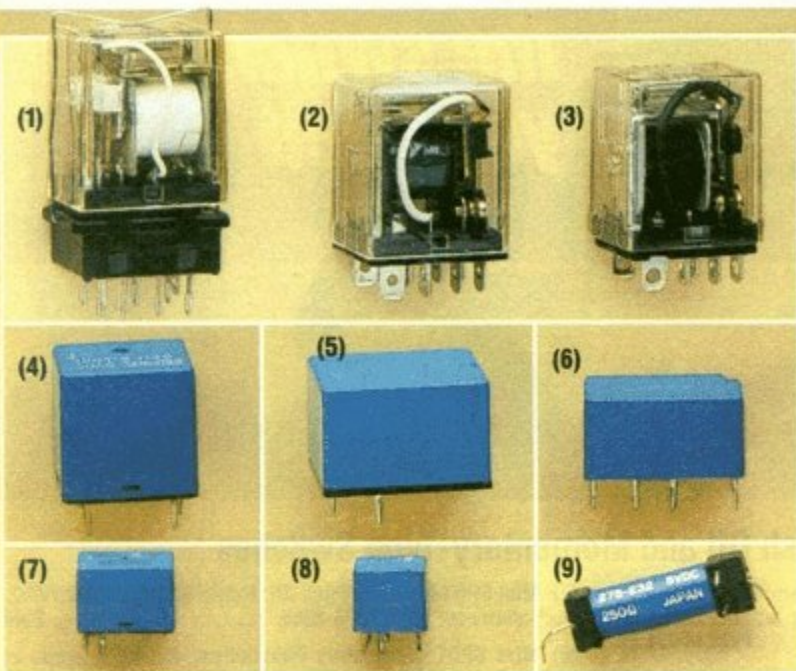

We Have an Archer Relay for Neary Every Project Need

Fig.	Description	Coil	Contacts and Rating	Size	Cat. No	Each
1	Plug-In With Socket	12VDC, 75 mA, 150Ω	DPDT. 3A at 125VAC	1 1/4 x 1 x 3/4"	275-206	5.99
2	10-Amp Plug-In	12VDC, 130 mA, 160Ω	DPDT. 10A at 125VAC	1 3/8 x 1 x 3/4"	275-218	5.99
	10-Amp Plug-In	125VAC, 15 mA, 4.5kΩ	DPDT. 10A at 125VAC	1 3/8 x 1 x 3/4"	275-217	5.99
...	Socket for Fig. 2	275-220	1.79
3	4PDT Plug-In	12VDC, 130 mA, 150Ω	4PDT. 3A at 125VAC	1 3/8 x 1 1/8 x 1 3/16"	275-214	5.49
...	Socket for Fig. 3	275-221	1.69
4	2-Amp SPDT Mini	7-9VDC, 18 mA, 500Ω	SPDT. 10A at 125VAC	3/4 x 3/4 x 9/16"	275-005	2.99
5	10-Amp SPDT Mini	12VDC, 38 mA, 320Ω	SPDT. 10A at 125VAC	9/16 x 25/32 x 5/8"	275-248	2.99
6	1-Amp DPDT Mini	12VDC, 43 Ma, 280Ω	DPDT. 1A at 125VAC	7/16 x 3/4 x 1/2"	275-249	3.99
7	2-Amp SPDT DIP	5VDC, 72 mA, 70Ω	SPDT. 2A at 125VAC	3/8 x 9/16 x 3/8"	275-243	2.39
8	1-Amp SPDT Micro	5VDC, 90 mA, 55Ω	SPDT. 1A at 125VAC	11/32 x 3/8 x 1/4"	275-240	1.99
	1-Amp SPDT Micro	12VDC, 37.5 mA, 320Ω	SPDT. 1A at 125VAC	11/32 x 3/8 x 1/4"	275-241	1.99
9	1-Amp SPST Reed	5VDC, 20 mA, 250Ω	SPST. 1A at 125VAC	1" x 5/16" dia.	275-232	1.89
	1-Amp SPST Reed	12VDC, 11 mA, 1.05kΩ	SPST. 1A at 125VAC	1" x 5/16" dia.	275-233	1.89

Transformers

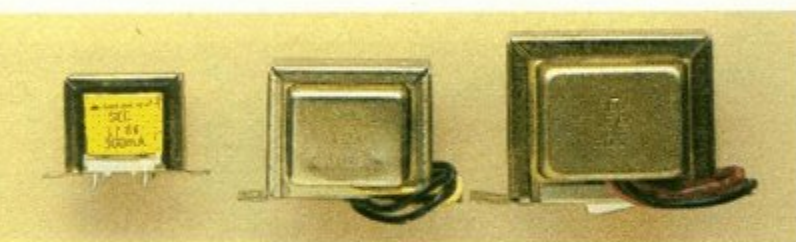

■ UL-recognized ■ Seven popular values in stock for project or replacement use

Miniature type has tabs and pins for mounting on printed circuit boards. Standard and heavy-duty types are metal-enclosed, have wire leads and mounting tabs. All primaries are for 120VAC. CT indicates a center tap in the secondary winding.

Type	Volts	Current	Body in Inches	Cat. No.	Each
Miniature	12.6	300 mA	1 1/4 x 1 7/16 x 1 1/16	273-1385	3.99
Standard	12.6 CT	450 mA	1 7/16 x 1 11/16 x 1 1/2	273-1365	4.99
Standard	25.2 CT	450 mA	1 11/16 x 1 15/16 x 1 3/4	273-1366	4.99
Standard	12.6 CT	1.2 A	1 11/16 x 1 11/16 x 1 11/16	273-1352	5.99
Heavy-Duty	12.6 CT	3.0 A	2 1/16 x 2 1/2 x 2 1/4	273-1511	8.99
Heavy-Duty	18.0 CT	2.0 A	2 1/16 x 2 7/16 x 2 3/8	273-1515	9.99
Heavy-Duty	25.2 CT	2.0 A	2 1/4 x 2 3/4 x 2 1/4	273-1512	9.99

RFI Fighters

(1) **Snap-Together Toroid Choke Core.** Wind cable through core and snap together. Opening: 7/8 x 7/8". Stackable. **273-104** Pkg. of 2/7.95

(2) **Snap-Together Ferrite Core.** Cuts RFI transmission or pickup. Easy to use. Snaps over computer and AC cables, audio leads, coax. **273-105** 4.99

(3) **100 μH Choke.** 2A. **273-102** .. 99¢

Electret Mike Elements

(1) **PC-Mount.** Omnidirectional. Wide 20-15,000 Hz response. Requires 2-10VDC. **270-090** 1.79

(2) **Omnidirectional.** Ideal for projects or repairing mikes. 30-15,000 Hz. With leads. 4-10VDC. **270-092**, 2.99

ArcherPaks

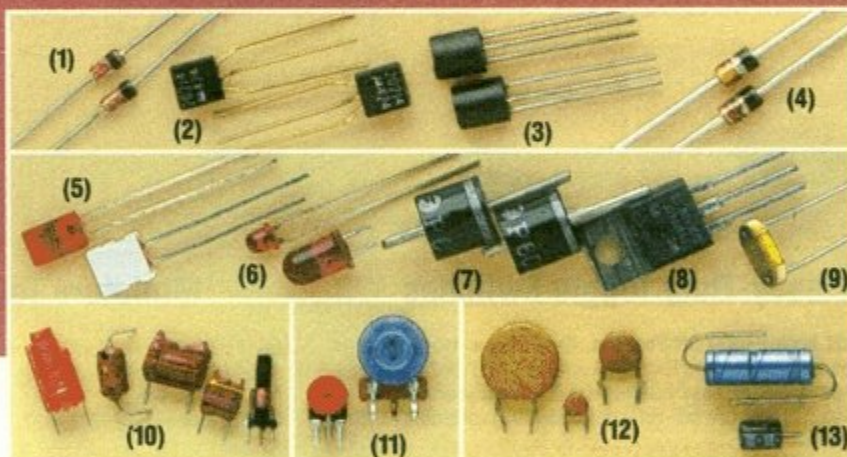

Bargains for Builders and Fixers — Only \$1.98 Each

- (1) **50 Silicon Switching Diodes.** 1N914/4148-type. **276-1620** 1.98
- (2) **15 NPN Transistors.** Switching type. 600 mW. **276-1617** 1.98
- (3) **15 PNP Transistors.** Similar to 2N3906. 350 mW. **276-1604** 1.98
- (4) **25 Rectifier Diodes.** Ten 1N4001s, five 1N4002s, five 1N4004s and five others are included. **276-1653** 1.98
- (5) **10 Rectangular LEDs.** May include red, green, yellow, regular and high-efficiency types. Light up projects and models at low cost. **276-1655** 1.98
- (6) **20 Assorted LEDs.** May include MV-series, green, red, amber, and infrared emitters. **276-1622** 1.98
- (7) **4 Rectifier Diodes.** Rated 6 amps. 50 PIV. **276-1661** 1.98
- (8) **5 Voltage Regulators.** Includes one 7805, one 7812 and three other types. For power supply projects and replacements. **276-1660** 1.98
- (9) **5 Photocells.** CdS photoresistors. Various styles and ratings. **276-1657** 1.98
- (10) **Inductor Assortment.** 30 pieces! May include RF, IF and video peaking coils, various small chokes and transformers. **273-1601** 1.98
- (11) **12 Trimmer Resistors.** Assorted styles and values. **271-1605** 1.98
- (12) **100 Disc Capacitors.** Many include NPO, Hi-Q, N750, mylar and ceramic types. Assorted values and voltage ratings. **272-801** 1.98
- (13) **20 Electrolytic Capacitors.** Assorted values and styles. **272-802** 1.98

DC Voltmeter



0 to 15VDC. Great for monitoring the voltage of a vehicle electrical system, battery charger or a power supply. Has a precision jeweled movement and mounts in a 1 7/8" -diameter round hole. **270-1754** 7.95

electronics Parts Place, SM the and servicing essentials

Fans

■ Eliminate damaging heat in computers, home and car audio amplifiers and Ham equipment

(1) **12VDC Brushless Micro Fan.** Tops for cooling mobile gear, hum-sensitive circuits. 3.5 CFM (cubic feet per minute) airflow. 150 mA. $1\frac{1}{16} \times 1\frac{1}{16} \times \frac{13}{32}$ " 273-244 17.95

(2) **12VDC Brushless 3" Fan.** Excellent for mobile stereo amps, boosters. Low 34 dB sound level. 27 CFM. $3\frac{5}{32} \times 4\frac{1}{16} \times 1\frac{1}{2}$ " 273-243 14.95

(3) **120VAC 3" Fan.** 32 CFM. Perfect for computers. 10 watts. UL recognized. $3\frac{5}{32} \times 3\frac{5}{32} \times 1\frac{1}{2}$ " 273-242 .. 16.95

(4) **120VAC 4" Fan.** Powerful 65 CFM airflow. 22 watts. UL recognized. $4\frac{1}{16} \times 4\frac{1}{16} \times 1\frac{1}{2}$ " 273-241, 18.95

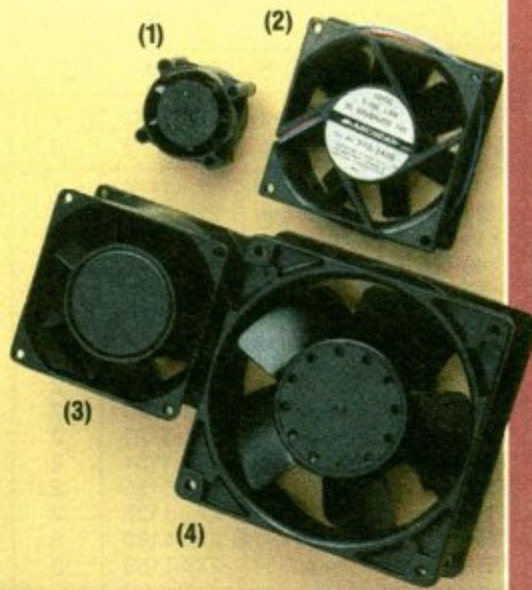

Hobby Motors

■ Add some motion to your projects

(1) **1½ to 3VDC.** Just the thing for solar power experiments, robotics, science projects and models. 8300 maximum RPM. About $1\frac{1}{2}$ " long by $\frac{15}{16}$ " diameter. 273-223 99¢

(2) **High-Speed 12VDC.** 15,200 RPM at no load. About 2" long (including shaft) by 1" diameter. 273-255, 2.99

(3) **NEW! Super High-Speed 9-18VDC.** Incredible 24,000 RPM at no load. 1.98A max. About 2" long (including shaft) by 1" diameter. 273-256, 3.49

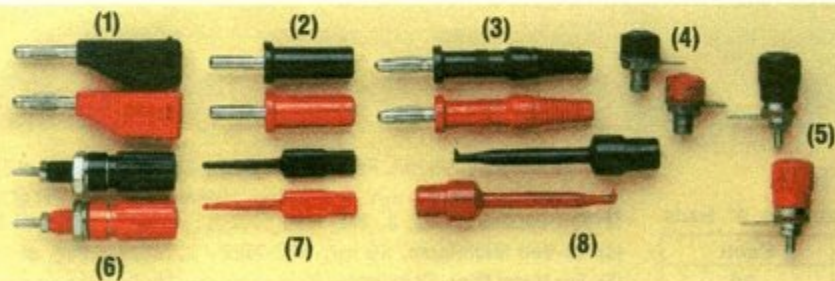
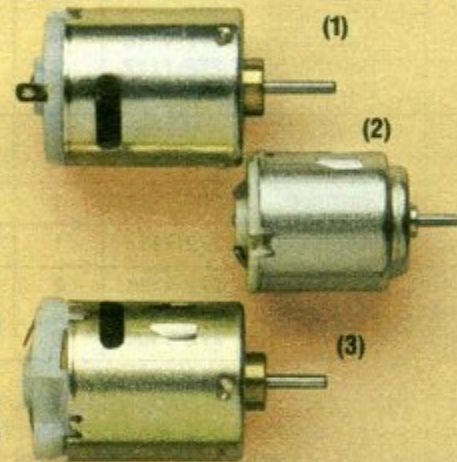

Banana Plugs, Binding Posts and Clips

■ Why put up with poor hookups? We have connectors that add reliability and a neat, professional appearance to projects and test equipment

(1) **Stackable Banana Plugs.** Built-in jack allows multiple "chain" connections. Solder type. Includes one red, one black. 274-734 Set of 2/1.59

(2) **Solderless Banana Plugs.** One red, one black. 274-721 Set of 2/1.59

(3) **Flex Banana Plugs.** Flexible strain relief. Ideal for building or repairing test leads. Solder type. One red, one black. 274-730 Set of 2/1.69

(4) **Banana Jacks.** Mount in $\frac{1}{4}$ "-diameter hole. One red, one black. 274-725 Set of 2/99¢

(5) **Multipurpose Posts.** Versatile—accept banana plugs, spades, phone tips, wires. Includes two red, two black. 274-661 Set of 4/2.39

(6) **Nylon Binding Posts.** For $\frac{3}{16}$ " mounting holes. Accept up to 14-gauge wire. One red and one black. 274-662 Set of 2/1.59

(7) **Rainbow Pack of Micro-Hook Clips.** Four different colors. 270-355 Set of 4/2.69

(8) **Mini Hook Clips.** One red, one black. 270-372 Set of 2/1.89

Audio Transformers

(1) **1:1 Audio Isolation Transformer.** For projects and hookups that connect to phone line, remote broadcasts and interstage coupling. 600 to 900 ohms impedance. 273-1374 3.59

(2) **Audio Output Transformer.** With a 1k-ohm center-tapped primary winding and an 8-ohm secondary. Many uses, including input, output and low-level impedance matching in audio circuits. $\frac{3}{4} \times \frac{5}{8} \times \frac{5}{8}$ " 273-1380 .. 1.69

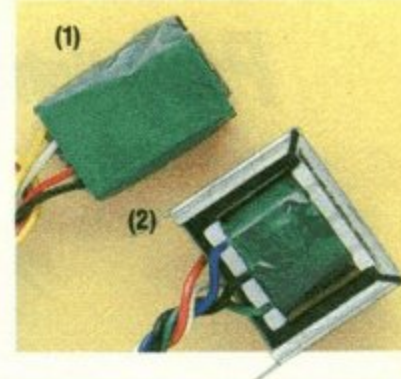

Car Battery Clips

■ Sets include one black, one red

(1) **50-Amp.** For big jobs like building or repairing automotive booster cables or charger leads. Open up to $1\frac{1}{8}$ ". 270-342 Set of 2/2.49

(2) **30-Amp.** Ideal for hookup to car battery posts. $3\frac{3}{8}$ " long. Open up to $1\frac{1}{8}$ ". 270-343 Set of 2/1.99

(3) **10-Amp.** $2\frac{1}{4}$ " long. Open up to $\frac{7}{8}$ ". 270-344 Set of 2/1.99

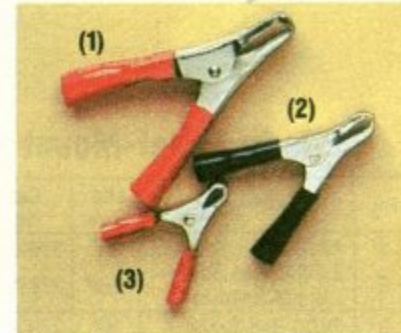

Tester Adapters

■ Dependable temporary hookups for scopes, counters and multimeters

(1) **Dual Binding Posts to BNC Male.** Posts have standard $\frac{3}{4}$ " spacing. 50Ω impedance. 274-715 8.95

(2) **Binding Post to Banana Plug.** Stackable. 274-716 Set of 2/4.95

(3) **Dual Inline Banana Plug.** Jacks accept test probes, probe wire and/or banana plugs. 274-717 2.99

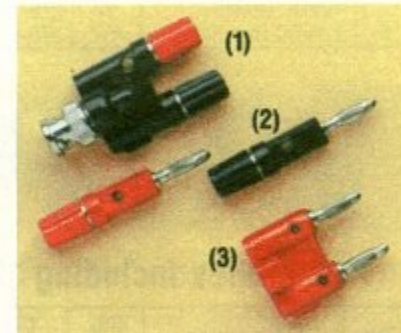

Test/Jumper Cable Sets

■ Alligator clip at each end, except #278-002, which has claw clips

(1) **Set of 10.** 14" long. Five different colors. 278-1156 Set of 10/3.99

(2) **Set of Four.** 30" long. Four colors. 278-001 Set of 4/3.69

(3) **Set of Eight.** 24" long. Four colors. 278-1157 Set of 8/3.99

(4) **Set of Six Heavy-Duty.** 40" long. Six colors. 278-002 Set of 6/4.69

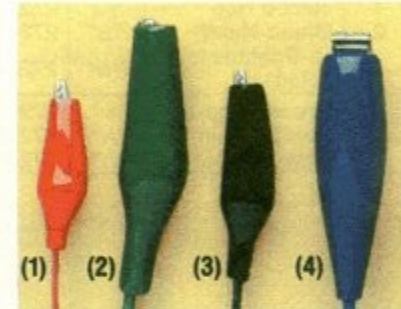

Super Selection of Test and Hookup Clips

(1) **$\frac{1}{8}$ " Mini.** Includes six red and six black. 270-1545 Set of 12/2.69

(2) **$\frac{1}{4}$ " Mini.** Three black, three red, two green, two yellow. 270-378 Set of 10/1.69

(3) **$\frac{1}{8}$ " Brass-Plated Micro.** Four red, four black. 270-1540 Set of 8/2.49

(4) **$2\frac{1}{4}$ " Alligator.** Screw terminals. Five red, five black. 270-375 Set of 10/2.39

(5) **$2\frac{5}{8}$ " Heavy-Duty Claw.** Rated 10A. Two red, two black. 270-349 Set of 4/2.19

(6) **$\frac{1}{4}$ " Claw.** Rated 5A. Two black, two red. 270-359 Set of 4/1.79

(7) **$2\frac{1}{4}$ " Alligator.** Screw terminals. Five red, five black. 270-347 Set of 10/2.19

(8) **$\frac{1}{8}$ " Mini Alligator.** Five red, five black. 270-374 Set of 10/1.59

(9) **2" Alligator.** Screw terminals. Two black, two red. 270-356 Set of 4/1.79

(10) **2" Slim.** With screw terminals. 270-346 Pkg. of 8/2.19

(11) **$\frac{1}{8}$ " Claw.** Rated 5 amps. Screw terminals. 270-345 Pkg. of 8/1.99

(12) **$\frac{1}{8}$ " All-Purpose Micro.** Copper-plated, smooth ends. 270-373 Pkg. of 10/1.89

(13) **$\frac{1}{4}$ " Mini.** Rated 1 amp. Solder type. 270-380 Pkg. of 12/1.79

Panel lights

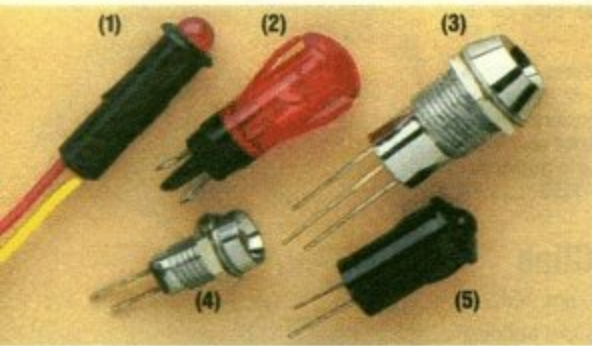

LEDs in Panel-Mount Holders

Fig.	Description	Mtg. Hole	Cat. No.	Pkg. of	Price
1	12VDC Red Snap-In	1/4"	276-011	1	1.99
2	2.2VDC Red Super-Bright Snap-In	11/32"	276-088	1	1.79
3	2VDC Red/Green	3/8"	276-025	1	1.49
4	12VDC Red	1/4"	276-068	2	1.89
5	12VDC Green	1/4"	276-069	2	1.89
5	2.1VDC Red Snap-In	3/16"	276-018	2	1.99

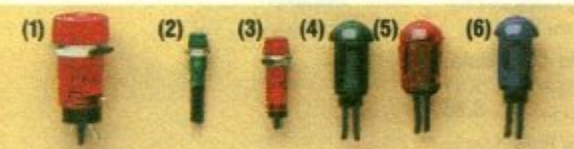

Assemblies Including 12V Bulb

Fig.	Description	Mtg. Hole	Cat. No.	Pkg. of 2	Price
1	Jumbo Red	19/32"	272-336	2	2.49
2	Green Micro	7/32"	272-334	2	1.99
3	Hi-Brightness Red	9/32"	272-331	2	1.59
4	Green Snap-In	1/2"	272-337	2	1.69
5	Red Snap-In	1/2"	272-332	2	1.79
6	Blue Snap-In	1/2"	272-335	2	1.79

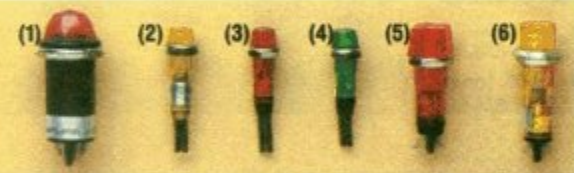

Assemblies With 120V Neon Bulb

Fig.	Description	Mtg. Hole	Cat. No.	Pkg. of	Price
1	Bright Jumbo Red	5/8"	272-710	1	1.99
2	Amber	9/32"	272-707	2	1.99
3	Red	5/16"	272-712	2	1.99
4	Green	5/16"	272-708	2	2.49
5	Square (Amber, Red)	7/16"	272-704	2	1.99
6	Round Version of Fig. 5	7/16"	272-705	2	1.99

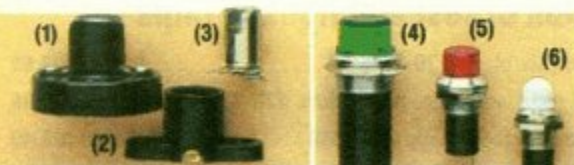

Values in Lamp Holders

Bulbs extra. Select by base style from lamp table above.

Fig.	Description	Cat. No.	Qty.	Price
1	E-10 Base. Screw Terms.	272-357	1	.99
2	Compact E-10 Base	272-356	1	.99
3	Bayonet Base. Solder Tabs	272-355	6	.99
4	Bayonet. 5/8" Mtg. Hole With 1 Red, 1 Green Lens	272-325	2	1.99
5	E-5 Base. 3/8" Mtg. Hole	272-326	2	2.19
6	E-5. 2 Red, 2 White Lenses	272-340	2	1.69

Lamps

Fig.	Volts	mA	Type	Base	Cat. No.	Pkg. of	Price
1	6.0	100	T-1-3/4	E-5 Threaded	272-1142	2	.99
	12.0	75	T-1-3/4	E-5 Threaded	272-1143	2	.99
2	1.2	250	112	E-10 Threaded	272-1174	1	.99
	2.33	270	243	E-10 Threaded	272-1124	2	.99
	2.47	300	14	E-10 Threaded	272-1132	2	.99
	6.3	150	40	E-10 Threaded	272-1128	2	.99
	6.3	250	46	E-10 Threaded	272-1130	2	.99
	7.5	220	50	E-10 Threaded	272-1133	2	.99
	14.0	200	1487	E-10 Threaded	272-1134	2	.99
3	2.33	270	PR-4	Flange	272-1122	2	.99
	2.38	500	PR-2	Flange	272-1120	2	.99
	3.57	500	PR-3	Flange	272-1121	2	.99
	4.75	500	PR-13	Flange	272-1151	2	.99
	4.8	500	PR-15	Flange	272-1125	2	.99
	5.95	500	PR-12	Flange	272-1123	2	.99
	7.2	550	PR-18	Flange	272-1168	2	.99
8.63	500	PR-20	Flange	272-1166	2	.99	
4	6.3	250	44	Bayonet	272-1108	2	.99
	6.3	50	47	Bayonet	272-1110	2	.99
	6.3	150	1847	Bayonet	272-1115	2	.99
	14.0	230	1891	Bayonet	272-1112	2	.99
	14.0	200	1815	Bayonet	272-1118	2	.99
	14.4	120	53	Bayonet	272-1117	2	.99
	28.0	40	1819	Bayonet	272-1119	2	.99
5	14.0	270	194	Wedge	272-1126	2	.99
	6.3	250	259	Wedge	272-1152	2	.99
6	12.8	1.04A	93	Bayonet	272-1116	1	.99
7	12.0	40	...	Bi-Pin	272-1154	1	1.29
8	120 (add 220k resistor) NE2 1/25-W Neon				272-1101	2	.69
	120 (add 22k resistor) NE2H 1/4-W Neon				272-1102	2	.69
	120 (has resistor) NE2 1/25W Neon				272-1100	2	.99

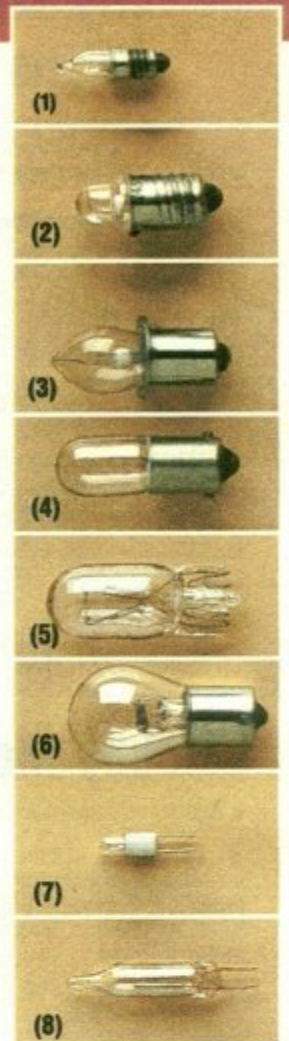

The table above lists premium-grade standard-type lamp bulbs. They're ideal for projects and replacement use in flashlights, dials, pilot lights and panels. Fig. 2, #272-1174/1124 are prefocus types used in many penlights. Fig. 6 is a high-intensity bulb. All are incandescent except the bulbs in Fig. 8, which are neon.

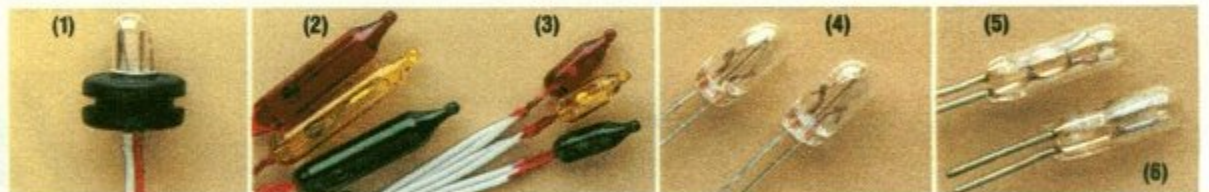

Miniature Lamps

(1) Mini Lamps. 25 mA. With grommet, 4" leads.

Volts	Cat. No.	Each
1.5	272-1139	.99
6.0	272-1140	.99
12.0	272-1141	.99

- (2) 12V Flashing. 95 mA. Red, yellow, green. 272-1097 . . . Set of 3/1.29
- (3) 6-Volt Colored. 60 mA. Red, yellow, green. 272-1098, Set of 3/99c
- 12-Volt Version of Fig. 3. 272-1099 Set of 3/99c
- (4) 12-Volt Microlamp. 60 mA. 272-1092 Pkg. of 2/1.39
- (5) For Metal Mini-Flashlights. Plug-in "bi-pin" bulbs for popular mini lights with adjustable focus. 2.5V, 300 mA. 272-1149 . . . Pkg. 2/2.99
- (6) **NEW!** Krypton Bulb for Mini-Flashlights. 2.5V. 272-1150 . . . 1.99

Super-Bright Krypton Lamps For Flashlights

Flange bases. Can replace standard PR-type flashlight lamps. For example, K4 replaces type PR-4.

Type	Volts	mA	Cat. No.	Each
K4	2.33	480	272-1169	.99
K1	2.4	600	272-1156	.99
K2	2.4	830	272-1157	.99
K3	3.6	800	272-1158	.99
K15	4.8	700	272-1162	.99
K12	6.0	650	272-1163	.99
K18	7.2	700	272-1164	.99
K222	2.33	600	272-1175	.99



Halogen Lamps

- (1) **NEW!** 12-Volt, 20-Watt. G-4 base, rated 350 lumens. Average life: 2000 hours. 272-1177, 1.99
- (2) HPR50. Replacement for 4-cell flashlights and 6-volt lanterns. 272-1189 3.95
- HPR52. For 2-cell flashlights and 3-volt lanterns. 272-1190 . . . 3.95

Long-Life Strobe Tube

This xenon-type strobe element is perfect for photography replacement and lighting effects projects. Trigger: 4 kV. Anode: 200 volts minimum, 300 volts max. With data. 272-1145, 3.29

Fuses



We Have the Fuses You Need for TVs, VCRs, Hi-Fi, CBs, Appliances, Testers and More

(1) Fast-Acting 1/4 x 1/4" Pkg. of 3/99c

Amps	Cat. No.	Amps	Cat. No.
1/4	270-1270	3	270-1276
1/2	270-1271	4	270-1277
3/4	270-1272	5	270-1278
1	270-1273	6	270-1252
1 1/2	270-1274	7	270-1253
2	270-1275	8	270-1254
2 1/2	270-1260	10	270-1325

Slow-Blow 1/4 x 1/4" Pkg. of 2/1.39

Amps	Cat. No.	Amps	Cat. No.
1/4	270-1326	2 1/2	270-1327
1/2	270-1282	3	270-1286
0.375	270-1328	4	270-1289
3/4	270-1329	5	270-1287
1	270-1283	6	270-1291
1 1/2	270-1284	7	270-1292
2	270-1285	8	270-1293

(2) Fuses for Microwave Ovens Pkg. of 2/1.39

Amps	Cat. No.	Amps	Cat. No.
10	270-1256	20	270-1258
15	270-1257

(3) Fast-Acting 5 x 20 mm Pkg. of 2/1.19

Amps	Cat. No.	Amps	Cat. No.
0.315	270-1249	2	270-1244
1/2	270-1241	2 1/2	270-1245
3/4	270-1242	3	270-1246
1	270-1250	4	270-1247
1 1/2	270-1243	5	270-1248

1.6-Amp 5 x 20 mm Fast-Acting Fuse. For VCRs. 270-1235 Pkg. of 2/1.19

NEW! 0.063-Amp 5 x 20 mm Fast-Acting Fuse. 270-1236 Pkg. of 2/1.29

(4) Slow-Blow 5 x 20 mm Pkg. of 2/1.39

Amps	Cat. No.	Amps	Cat. No.
1/2	270-1169	3.15	270-1173
3/4	270-1170	4	270-1174
1	270-1171	5	270-1175
2	270-1172	6.3	270-1176



Automotive Fuses and Fuse Kits

Glass-Type Fuse Kit. Be prepared, keep spares! Kit includes two SFE-20, one each of AGC3, 10, 15, 25, 30, one each of SFE 7 1/2, 9, 14. 270-1262 Set of 10/1.99

SFE-Type. 1/4 x 1/4"-diameter glass fuses.

Amps	Cat. No.	Pkg. of 3
5	270-1263	.99
10	270-1279	.99
15	270-1280	.99
20	270-1268	.99

"Blade"-Type Fuse Kit. This set includes one each of the most popular sizes: 5, 7 1/2, 10, 15, 20 amps. 270-1201 Set of 5/1.99

"Blade"-Type Automotive Fuses Pkg. of 2/99c

Amps	Cat. No.	Amps	Cat. No.	Amps	Cat. No.
5	270-1205	15	270-1212	25	270-1214
10	270-1207	20	270-1208	30	270-1209

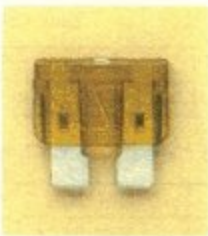

Thermal Protector Fuses

Used as a protector in many coffeemakers and heating-type appliances. Rated 240VAC, 10 amps. Each 1.29

Breaks Circuit at	141° C	128°	228° C
Cat. No.	270-1320	270-1322	270-1321

MOV AC Line-Surge Protectors

Metal-Oxide Varistors. Divert power-line voltage spikes to ground. Help prevent costly damage to electronic equipment. Standard MOV. 276-570 .. 1.59 Heavy-Duty. 276-568 .. 1.99

Panel-Mount Circuit Breaker

Easy way to add safety. Snaps into 5/8"-diameter panel hole. Rated 3 amps at 250VAC. Trips in three seconds at 200% rated current. 270-1311 1.99

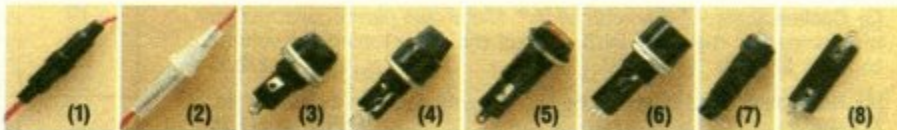

Holders for 1/4 x 1/4", 5 x 20 mm and "Blade" Fuses

- (1) In-line for 5 x 20 mm Fuse. Rated 5A at 250VAC. 270-1238 1.59
- (2) In-line for 1/4 x 1/4" Fuse. Rated 5A at 250VAC. 270-1281 1.19
- (3) Panel-Mount for 5 x 20 mm Fuse. 10A at 250VAC. Mounts in 1/2" hole. 270-362, 1.49
- (4) Round Panel-Mount for 1/4 x 1/4" Fuse. Rated 10A at 250VAC. 270-364 1.29
- (5) Square Panel-Mount for 1/4 x 1/4" Fuse. 10A at 250VAC. 1/2" hole. 270-365 .. 1.49
- (6) Panel-Mount for 1/4 x 1/4" Fuse. Screwdriver slot. 10A/250VAC. 270-367 1.79
- (7) **NEW!** Universal Panel-Mount. Accepts standard 1/4 x 1/4", 5 x 20 mm and 2AG fuse sizes. Rated 10A at 250VAC. Mounts in 1/2" hole. 270-368 1.99
- (8) Chassis-Mount for 1/4 x 1/4" Fuse. 270-739 Pkg. of 2/99c
- (9) Four-Position Block for 1/4 x 1/4" Fuses. 270-742 2.29
- (10) **NEW!** PC-Mount Clips. Pairs for 1/4 x 1/4", 5 x 20 mm, blade. 270-744, Set of 6/1.19
- (11) Pigtail Fuse Adapter. Quick solderless fuse servicing! Snaps over blown pigtail-type 1/4 x 1/4" fuse. New fuse snaps into holder. 270-1219 1.29

Car Fuse Holders and Accessories

- (1) Solderless Holder for 1/4 x 1/4" Glass Fuse. Rated for fuse up to 20 amps. 270-1211 1.19
- (2) In-line "Blade" Fuse Holder. Rated for fuse up to 20 amps. 270-1213 1.79
- (3) Inserter/Extractor Tool. Install and remove both glass and "blade"-type fuses without damage. 270-1199, 99c
- (4) Self-Strip "Blade" Fuse Holder. Easy to install. Just insert wire and squeeze. 270-1215 1.49
- (5) "Blade" Fuse Taps. Fast and easy way to connect car audio, CB and accessory power leads to vehicle's fuse panel. 270-1204 Pkg. of 4/99c

Big Selection of Battery Holders

Have leads except * which have 9V-type snap.

Holds	Cat. No.	Each	Holds	Cat. No.	Each
2 "AAA"	270-398	.79	4 "C"	270-390	1.49
2 "AA"	270-382*	1.19	2 "D"	270-386	1.49
4 "AA"	270-383*	1.29	4 "D"	270-396	1.59
4 "AA"	270-391	1.29	4 "D"	270-389	1.59
8 "AA"	270-387*	1.39	1 "N"	270-405	.59
8 "AA"	270-407*	1.39	1 "AA"	270-401	.69
2 "C"	270-385	1.29	1 "C"	270-402	.79
			1 "D"	270-403	.89

- (1) 9V Battery Snap Connectors. 270-325 .. Pkg. of 5/1.29
- (2) 9V Battery Holders. 270-326 Pkg. of 2/99c

Replacement Rod Antennas

For cordless phones, radios, portable stereos and walkie-talkies. Other styles available via fast CMC special order.

Fig.	Sections	Extends to	Cat. No.	Each
1	5	30 1/2"	270-1401	3.19
1	4	34 3/4"	270-1402	3.99
1	3	39 1/2"	270-1403	4.19
1	6	72"	270-1408	4.19
2	5	15 1/2"	270-1406	2.99
3	5	28"	270-1405	3.29
4	5	13"	270-1407	2.99
4	6	17 3/4"	270-1409	2.79
4	6	16"	270-1410	3.19
5	6	11 1/4"	270-1411	3.19
6	2	16 1/2"	270-1412	2.99
6	9	24"	270-1413	4.19
6	5	13 1/2"	270-1414	2.59
7	5	13 7/16"	270-1415	2.79
8	5	22 3/4"	270-1416	3.99
9	4	23 3/4"	270-1417	3.49

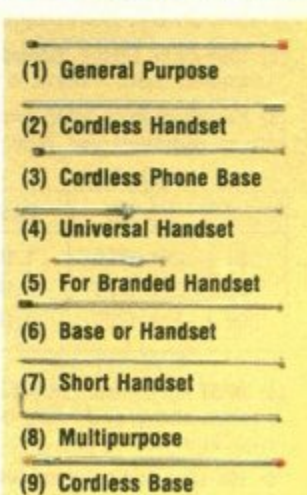
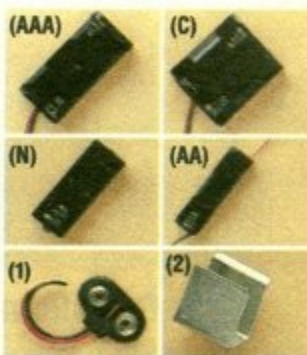
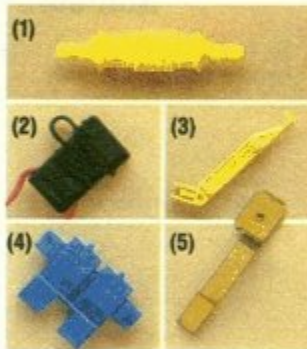

Resistors

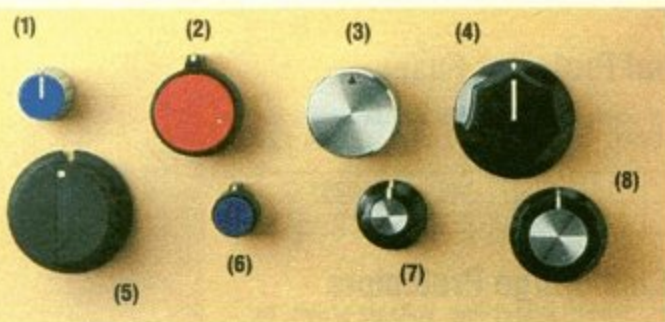

Knobs for 1/4" Shafts

■ With quality brass bushings and set screws

- (1) **Two-Color.** 19/32" by 11/16" deep. Gray base and blue cap, knurled grip finish. 274-428 Pkg. of 1/1.79
- (2) **Red Insert.** 1" diameter by 5/8". Use with blue insert style, below, to color-code controls. 274-433, Pkg. of 2/1.29
- (3) **Contemporary.** 1" diameter by 5/8". Metal over plastic construction with handsome engraved finish. Perfect choice for tuning and volume controls. 274-424 Pkg. of 2/2.19
- (4) **Hexagonal.** 1 1/4" diameter by 5/8". Quality knobs in a classic style. 274-407 Pkg. of 2/1.29
- (5) **Communications.** 1 1/2" diameter by 11/16". Knurled grip and groove pointer. 274-402 Pkg. of 2/1.19
- (6) **Blue Insert.** 1/2" diameter by 3/8". Match our popular #270-220-series enclosures. 274-403 Pkg. of 2/99c
- (7) **Hexagonal With Aluminum Insert.** 3/4" diameter by 7/16". Knurled plastic grip. 274-415 Pkg. of 4/1.69
- (8) **Jumbo Version of Fig. 7.** 1" by 9/16". 274-416 4/1.99



1/2-Watt, 10% Tolerance Carbon Resistor 2-Paks — Only 29¢ Each

Ohms	Cat. No.	Ohms	Cat. No.	Ohms	Cat. No.	Ohms	Cat. No.
10	271-001	180	271-014	1.2k	271-024	22k	271-038
15	271-003	220	271-015	1.5k	271-025	33k	271-040
22	271-005	270	271-016	2.2k	271-027	47k	271-042
33	271-007	330	271-017	3.3k	271-028	100k	271-045
47	271-009	390	271-018	3.9k	271-029	220k	271-049
68	271-010	470	271-019	4.7k	271-030	470k	271-053
82	271-011	560	271-020	5.6k	271-031	1 meg	271-059
100	271-012	680	271-021	10k	271-034	2.2 meg	271-061
150	271-013	1k	271-023	15k	271-036		

1/4-Watt, 5% Tolerance Carbon Resistor 5-Paks — Only 39¢ Each

Ohms	Cat. No.	Ohms	Cat. No.	Ohms	Cat. No.	Ohms	Cat. No.
10	271-1301	470	271-1317	15k	271-1337	470k	271-1354
100	271-1311	1k	271-1321	22k	271-1339	1 meg	271-1356
150	271-1312	2.2k	271-1325	33k	271-1341	10 meg	271-1365
220	271-1313	3.3k	271-1328	47k	271-1342
270	271-1314	4.7k	271-1330	100k	271-1347
330	271-1315	10k	271-1335	220k	271-1350



Dial Cord Replacement Kit

Six feet of high-strength replacement dial cord with three assorted tension springs. 274-435 99c



Wirewound Resistors

Ohms	Watts	Cat. No.	Price
0.47	5	271-130	Ea./ .59
1.0	10	271-131	2/.99
10.0	10	271-132	2/.99
10.0	2	271-080	2/.99
50.0	10	271-133	2/.99
100.0	10	271-135	2/.99

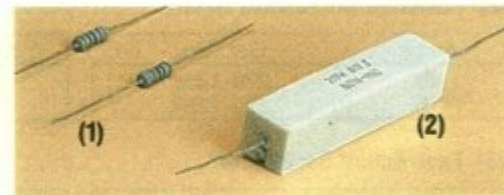

Metal-Oxide & Non-Inductive

(1) **Metal-Oxide.** One watt. 5% tolerance.

Ohms	Cat. No.	Pkg. of 2
10	272-151	.29
100	272-152	.29
1000	272-153	.29

(2) **8-Ohm Non-Inductive.** Rated 20 watts. 5% tolerance. 271-120 1.49



Color-Code Guide

Pocket size. Just match colors to get a fast and accurate readout of the coded values on resistors, capacitors and inductors. It's really handy and simple to use. Speeds service work and hobby construction. 271-1210 99c

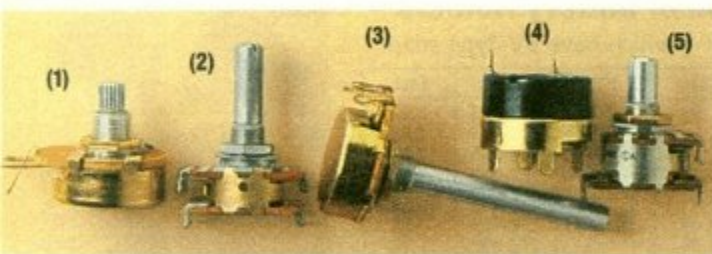

Potentiometers and Switch

- (1) **2-Watt Rheostat.** 25-ohm \pm 20% wirewound. Rated 2 watts continuous, 5 watts intermittent. 271-265 2.99
- (2) **100k-Ohm Stereo Control.** 40% loudness tap. 1/2"-long, 1/4"-diameter shaft. Mounts in 3/8" hole. 271-1732 1.99
- (3) **Potentiometers.** With 6mm-diameter shaft suitable for 1/4" applications. Mount in 5/16" hole.

Audio Taper			Linear Taper		
Ohms	Cat. No.	Each	Ohms	Cat. No.	Each
5k	271-1720	1.19	5k	271-1714	1.19
10k	271-1721	1.19	10k	271-1715	1.19
100k	271-1722	1.19	50k	271-1716	1.19
			100k	271-092	1.19
			1 meg	271-211	1.19

(4) **SPST Pot Switch.** On/off switch mounts on rear of potentiometers in tables above and many others. Rated 3 amps at 120VAC. With instructions. 271-1740 99c

(5) **10k-Ohm Audio Control With SPST Switch.** Mini size with 1/4" shaft. Switch rated 3 amps at 30VDC. Fits 5/16" hole. 271-215 1.99



Resistor Assortments, Thermistor and PC-Mount Trimmers

- (1) **1/4-Watt Metal-Film Assortment.** 1% tolerance. 50-piece set of 12 popular values. 271-309 Set 2.29
- 1/4-Watt Carbon Assortment.** 5% tolerance. 100-piece set of 13 popular values. 271-308 Set 2.99
- 1/4-Watt Carbon-Film Assortment.** 5% tolerance. 500-piece set, 54 values. 271-312 Set 7.95
- 1/2-Watt Carbon Assortment.** 10% tolerance. 100-piece set, 21 popular values. 271-306 Set 3.49

(2) **Precision Thermistor.** Heat sensitive. Resistance changes in proportion to temperature. Has -50 to +110° C range. Measures 10k-ohm at 25° C. 271-110 1.99

(3) **Horizontal-Style Trimmers.** Micro-size. Rated 0.1W, 50VDC Each 49c

Ohms	Cat. No.	Ohms	Cat. No.	Ohms	Cat. No.	Ohms	Cat. No.	Ohms	Cat. No.
1k	271-280	4.7k	271-281	10k	271-282	47k	271-283	100k	271-284

(4) **15-Turn Trimmers.** PC-mount. Adjustment screw. Ideal for circuit fine-tuning. Rated 3/4-watt Each 1.49

Ohms	Cat. No.	Ohms	Cat. No.	Ohms	Cat. No.
1k	271-342	10k	271-343	20k	271-340

Capacitors

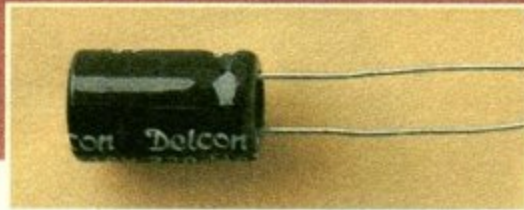
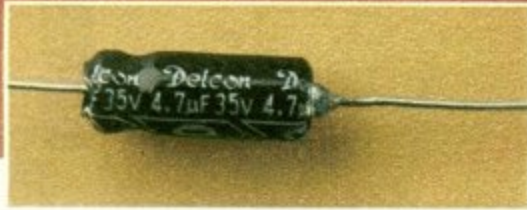

Electrolytic Capacitors

Axial-type leads

μF	WVDC	Cat. No.	Each
4.7	35	272-1012	.49
10	35	272-1013	.59
22	35	272-1014	.69
47	35	272-1015	.69
100	35	272-1016	.99
220	35	272-1017	.99
470	35	272-1018	.99
1000	35	272-1019	1.59
2200	35	272-1020	2.49
4700	35	272-1022	3.59
1000	50	272-1047	1.99
2200	50	272-1048	3.49

Radial-type leads

μF	WVDC	Cat. No.	Each
220	16	272-956	.99
470	16	272-957	.99
1000	16	272-958	.99
4.7	35	272-1024	.49
10	35	272-1025	.59
22	35	272-1026	.69
47	35	272-1027	.69
100	35	272-1028	.99
220	35	272-1029	.99
470	35	272-1030	.99
1000	35	272-1032	1.59
100	50	272-1044	.99



Hi-Q Ceramic Discs

All have moistureproof coating and Hi-Q design for low-loss in RF circuits. Extra-long leads.

0.1 μF, 2 kV Ceramic Disc Capacitor. Popular value with a large voltage rating. Suitable for demanding bypass and coupling jobs. 272-160 Pkg. of 2/99c

pF	WVDC	Cat. No.	Pkg. of 2
4.7	50	272-120	.39
47	50	272-121	.39
100	50	272-123	.39
220	50	272-124	.39
470	50	272-125	.39

μF	WVDC	Cat. No.	Pkg. of 2
.001	500	272-126	.49
.0047	500	272-130	.49
.01	500	272-131	.49
.047	50	272-134	.49
.1	50	272-135	.59



Tantalums

High capacity in a small package. IC pin spacing. 20% tolerance.

μF	WVDC	Cat. No.	Each
0.1	35	272-1432	.59
0.47	35	272-1433	.59
1.0	35	272-1434	.59
2.2	35	272-1435	.69
10	16	272-1436	.79



Non-Polarized Electrolytics

50 WVDC. For speaker crossovers and audio filters.

μF	Approx. Crossover Frequency (8 Ohms)	Cat. No.	Each
1.0	10 kHz	272-996	.99
2.2	8 kHz	272-997	.99
4.7	4 kHz	272-998	.99
10.0	2 kHz	272-999	.99



PC-Mount

Rated 50 WVDC

μF	Cat. No.	Pkg. of 2
.01	272-1065	.59
.022	272-1066	.69
.047	272-1068	.69
.1	272-1069	.79
.22	272-1070	.89



Monos & Picos

(1) 0.1 μF Monolithic. 50 WVDC. Perfect for chip bypass. 272-109, Pkg. of 5/1.79
(2) Picos. 50WVDC. To 33 pF. 272-806, Set. of 50/2.99

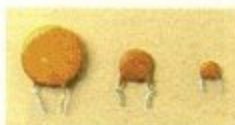

Assorted Discs

Up to 1000 WVDC. Bargain! 100-piece set may include NPOs, Hi-Qs, N-750s and ceramics. Variety of values. 272-801 Set of 100/1.98



Electrolytic Assortment

Up to 50 WVDC. Minis and subminis, a variety of values. 272-802 Set of 20/1.98



Trimmer

95-420 pF. Compression type. Dielectric strength: 100 VDC (one minute). Q greater than 500 at 1 MHz. About 1/8 x 1/8". 272-1336 1.69



Metal-Film

Rated 200 WVDC

μF	Cat. No.	Each
.01	272-1051	.49
.1	272-1053	.69
1.0	272-1055	.99

Buzzers! Big variety of sound makers in stock

Piezo Transducers

Piezo Speaker. Only 1³¹/₃₂" -diameter by 5/₆₄" thin. This high-efficiency, 1200-ohm device can be driven directly by an IC. Range: 500 Hz to 20 kHz. 273-091 2.49

1500 to 3000 Hz Piezo Element. 2-wire type requires a driver circuit. 273-073 .. 1.49

Fixed-Frequency Piezo Element. 6.5 kHz. This 3-wire transducer requires an external driver circuit. 273-064 1.79

Efficient Piezo Buzzers

Draw only 7 milliamps at 12VDC

PC-Mountable. Produces 4.2 kHz at a surprising 70 dB level. Mini size, a good choice when board space is limited. 273-074 .. 2.99

Panel-Mount. Provides pulsing or continuous 3.5 kHz tone. 95 dB level. With tabs for mounting. 273 273-075 6.95



More Piezo Buzzers

Two-Tone. Super loud! Up to 100 dB sound level at 2500 Hz. Has attenuator vanes and operates from 8 to 16 VDC. Draws about 130 mA at 12VDC. A good choice for a vehicle backup alerter. 273-070 10.95

Pulsating or Continuous. 2800 Hz. Produces 90 dB at 12VDC. 273-068 8.49

Pulsating. 2800 Hz, up to 90 dB. Operates from 3 to 28VDC. 273-066 4.29

With Leads. 3.6 kHz, up to 85 dB. Operates from 4 to 28 VDC. 273-060 3.29

PC-Mount. 2800 Hz, up to 78 dB. Operates from 3 to 20 VDC. 273-065 2.49



Miniature DC Buzzers

12-Volt Magnetic Buzzer. More pleasing tone than a single-frequency piezo buzzer, without higher current consumption. About 85 dB. 3.4 kHz. 6-16VDC. Draws 10 mA at 12VDC. Mounting centers: 1¹/₂". 273-026 2.19

NEW! PC-Mount Magnetic Buzzer. Produces 2300 Hz signal up to 85 dB. Operates 10 to 14VDC. About 30 mA at 12VDC. 3/₈" diameter. PC-mount pins. 273-027 2.49

Electronic Buzzers. 1¹/₁₆" mounting centers. With hookup leads Each 2.49

DC Voltage	Cat. No.
1 ¹ / ₂ to 3	273-053

DC Voltage	Cat. No.
6	273-054

DC Voltage	Cat. No.
12	273-055

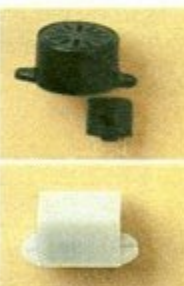

Electromechanical Buzzer

This super-loud DC buzzer in a sturdy metal case is just the thing for battery-powered alerters and alarm circuits. 1¹⁵/₁₆" diameter by 1¹/₄" deep. 273-051 2.49



"Ding-Dong" Chime

Panel-mount IC and minispeaker combo is great for door and customer-entry alarms. Adds a classic sonic touch to projects and science demos, too. It operates from 6 to 18VDC and produces about 80 dB output at 12VDC. Has 5" hookup leads. 273-071, 8.99



Mini Audio Amplifier/Speaker



Ideal for voice/music uses, phone, project or test amp. High-gain IC circuit, rotary volume control. Has $\frac{1}{8}$ " earphone and input jacks. $3\frac{3}{8} \times 3\frac{3}{16} \times 1\frac{3}{4}$ ". Requires 9V battery or DC adapter. 277-1008 11.95



Solar Project Set

Ideal for powering your model parts! Also great for science class, scouts and building projects. Includes solar cell pre-wired to DC motor, color wheels, propeller and data booklet. 277-1201 10.95



Silicon Solar Cell

Harness the sun with this efficient 2×4 cm cell. Delivers about 0.3A at 0.55VDC in full sunlight. Use several to charge batteries or projects. 276-124 ... 3.95

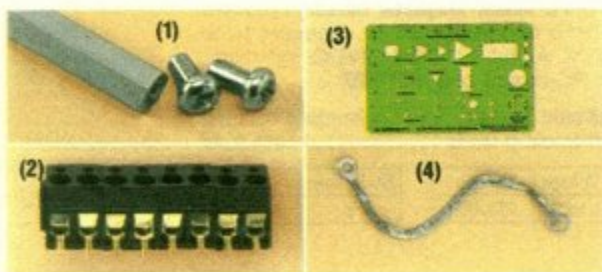

PC Board Accessories

- (1) Standoffs With Screws. These $\frac{1}{16}$ "-high metal studs simplify board mounting. 276-195 Set of 4/1.19
- (2) PC Board Wire Terminals. Two-position. For reliable wire hookups. 276-1388 Pkg. of 4/1.99
- (3) Circuit Symbols Template. This durable guide makes it easy to draw industry-standard schematics. 276-180 3.95
- (4) 4" Grounding Strap. Heavy-duty. Crimped, soldered eyelet. Low-resistance ground fights RFI. 278-1155 59¢

PC project boards

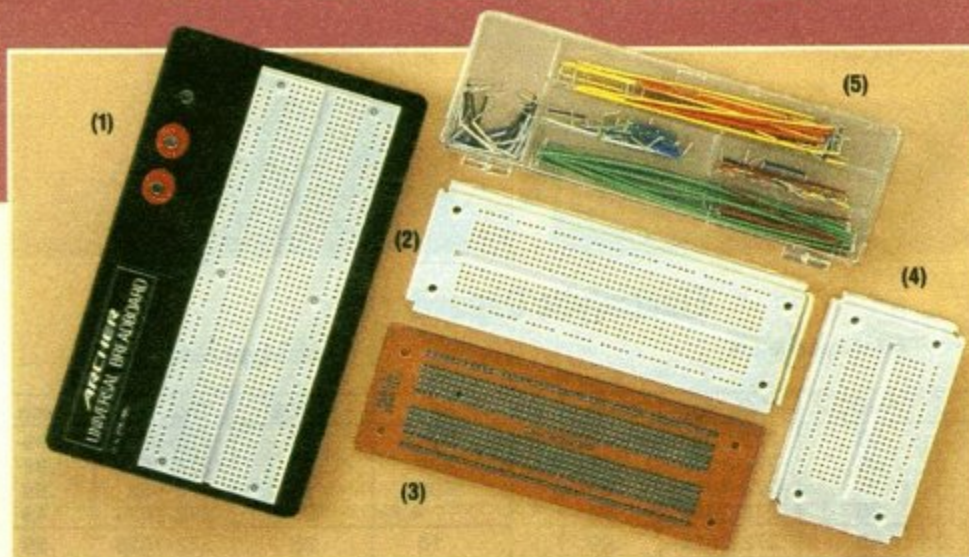

Solderless IC Breadboards and Accessories

- The fast way to design your own circuit
- Each accepts a wide variety of devices

- (1) **Universal Breadboard.** Our finest! This $2\frac{1}{4} \times 6\frac{1}{2}$ " molded board is mounted on a 7×4 " "stay put" steel base with rubber feet. Accepts DIPs, discrete components and jumper wires (Fig. 5 recommended). Provides a total of 640 plug-in tie points and has three binding posts for external connections. 276-169, 19.95
- (2) **6" Modular IC Breadboard Socket.** Silver-nickel low-resistance contacts, 550 indexed connect points. $2\frac{1}{8} \times 6$ ". 276-174 11.95

- (3) **Matching Printed Circuit Board.** Layout matches modular breadboard sockets shown in this section. Features a total of 550 predrilled, indexed connect points. $2\frac{1}{16} \times 6 \times \frac{1}{16}$ ". 276-170 2.79
- (4) **Modular IC Breadboard Socket.** Smaller version of Fig. 2 with 270 connection points. $2\frac{1}{8} \times 3\frac{5}{8} \times \frac{1}{16}$ ". 276-175 7.49
- (5) **Jumper Wire Kit.** Speeds building! Includes 140 insulated, pre-stripped wires—10 each of 14 different lengths—in a snap-shut plastic box. 276-173 Set 4.95

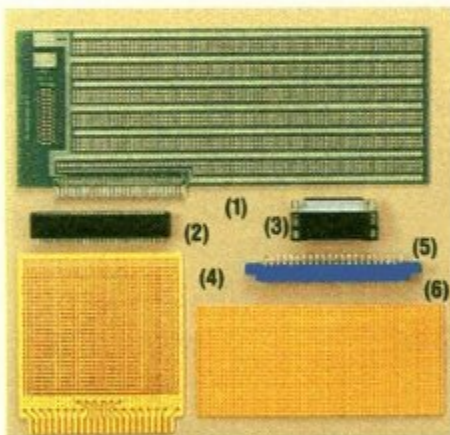

Plug-Ins and Perfboards

- (1) PC/XT Plug-In Board. 276-1598 29.95
- (2) 62-Pos. PC/XT Bus Card-Edge Connector. For short cards. 276-1453 2.95
- (3) DB25 Fem. Rt.-Angle Conn. 276-1504, 2.69
- (4) 44-Position Plug-In Board. 276-154, 3.49
- (5) 44-Pos. Card-Edge Connector. 276-1551, 2.99
- (6) IC-Spacing Perfboard. Have 0.42" pre-punched holes in standard .100 x .100" grid.

Size	Cat. No.	Each
$2\frac{3}{4} \times 6$ "	276-1395	1.99
$4\frac{1}{2} \times 6$ "	276-1394	2.19
6×8 "	276-1396	2.99

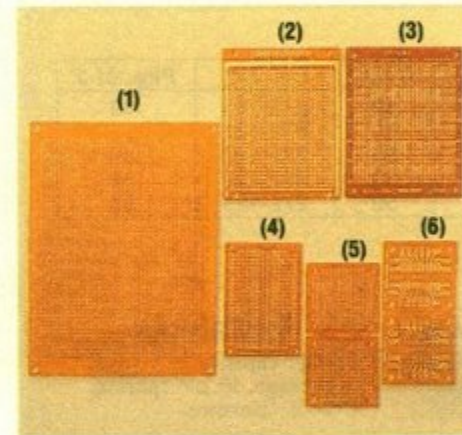

Predrilled Boards

- (1) **Grid.** Solder-ringed holes accept DIPs, sockets, headers. Indexed for pin-out ID.

Size	Holes	Cat. No.	Each
$4\frac{1}{2} \times 6\frac{5}{8}$ "	2200	276-147	3.79
$2\frac{3}{4} \times 3\frac{3}{4}$ "	750	276-158	2.29
$1\frac{27}{32} \times 2\frac{27}{32}$ "	356	276-149	.99

- (2) **Universal.** 750 holes. For DIPs up to 40 pins. Indexed. $3\frac{3}{8} \times 7\frac{7}{8}$ ". 276-168 2.29
- (3) **IC/LSI.** $2\frac{13}{16} \times 2\frac{7}{8}$ ". 276-162 2.29
- (4) **Multipurpose.** $1\frac{27}{32} \times 2\frac{27}{32}$ ". 276-150, 99¢
- (5) **Dual Mini.** $1\frac{3}{4} \times 3\frac{5}{8}$ ". 276-148 1.39
- (6) **Dual IC.** $1\frac{3}{4} \times 3\frac{3}{8}$ ". 276-159 1.49

Etch Your Own PC Boards

- (1) **PC Board Kit.** Two $4\frac{1}{2} \times 3$ " copper-clad boards, resist-ink pen, solvent, etchant, layout strips and circles, tank, $\frac{1}{8}$ " drill bit and easy-to-follow instructions. 276-1576 9.95
Extra Pen. 276-1530 1.79
Extra Etchant. 16 oz. 276-1535 2.69
- (2) **2-Sided Board.** $4\frac{1}{2} \times 6\frac{3}{8}$ ". 276-1499, 3.99
- (3) **Direct-Etch Dry Transfers.** 276-1577, 4/2.99

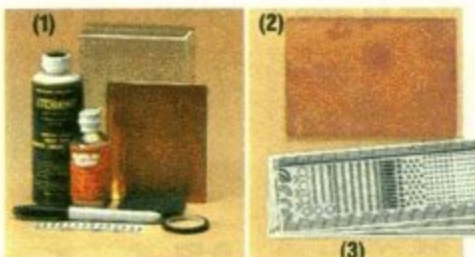

Computer hookups



Twisted-Pair Networking

- Use phone wire instead of more costly shielded cable in local area networks

RS-232 to Modular Adapter

Female D-sub 25 to RJ-45 (8-1 position) modular jack. 276-1406 4.49

Male D-Sub 25 Connector

Connects up to six RS-232 peripheral lines of your choice. 276-1405 2.99

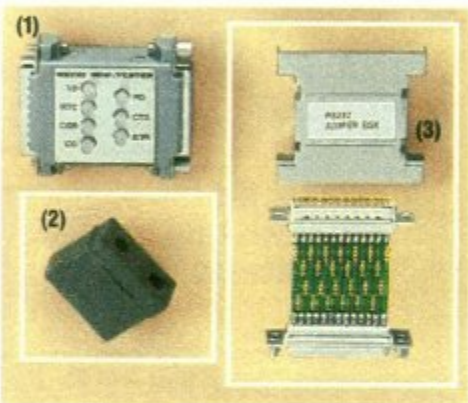

Parts to Help With Your Peripheral Hookups

(1) **RS-232 Troubleshooter.** Spot problems fast! Dual-color LEDs monitor seven data/control lines. D-sub 25. Connects inline. 276-1401 14.95

(2) **DIP Programming Shunts.** Two-position. Used in many computer boards. 276-1512 10/1.29

(3) **Shielded Shunt Box.** Wire the included PC board to suit your application. 276-1403, 9.95

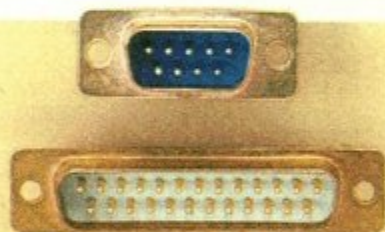

Solder-Type D-Subs

- Gold-plated pins and terminals

Positions	Type	Cat. No.	Each
9	Male	276-1537	.99
9	Female	276-1538	1.29
25	Male	276-1547	1.49
25	Female	276-1548	1.99



Crimp-Style D-Subs

- Durable, gold-plated contacts

Pos.	Type	Cat. No.	Each
9	Male	276-1427	.99
9	Female	276-1428	1.49
25	Male	276-1429	1.99
25	Female	276-1430	2.49

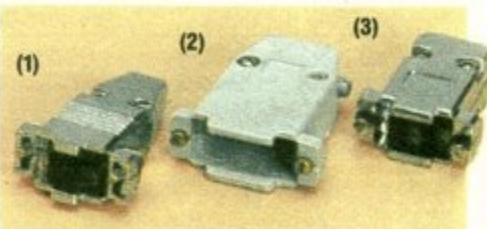

D-Sub Hoods

Fig.	Description	Cat. No.	Each
1	9-Position Metal	276-1508	2.19
...	25-Position Metal	276-1510	2.79
2	9-Position Nonshielded	276-1539	.79
...	25-Position Nonshielded	276-1549	.89
3	9-Position Metalized	276-1513	1.49
...	25-Position Metalized	276-1536	1.99

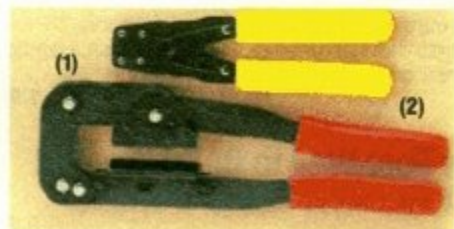

D-Sub and IDC Tools

(1) **D-Sub Pin Crimper.** Professional steel tool accepts #20, #24 and #28 pins. 6⁷/₈" long. (CMC) 276-1595 9.95

(2) **IDC Connector Tool.** Attaches IDC-type connectors to flat cables. 9¹³/₁₆" long. (CMC) 276-1596 12.95

CMC items are available by special order through your local Radio Shack.

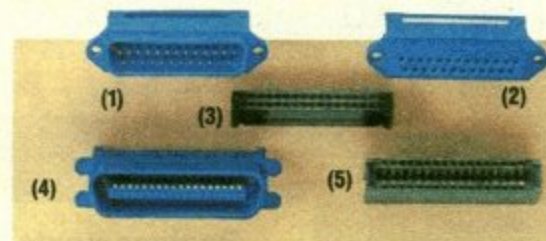

Solderless IDC-Type Connectors

Fig.	Description	Cat. No.	Each
1	25-Position D-Sub Male	276-1559	3.99
2	25-Position D-Sub Female	276-1565	3.99
3	34-Position Header	276-1525	2.49
4	36-Position Male Printer	276-1533	4.99
5	34-Position Card Edge	276-1564	1.99

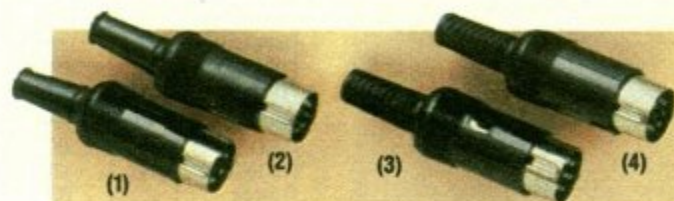

Popular DIN Plugs

Fig.	Positions	Cat. No.	Each
1	4	276-007	1.69
2	5	276-003	1.69
3	6	276-020	1.79
4	8	276-026	1.79

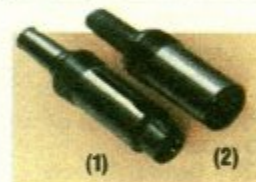

Inline DIN Jacks

Use with plugs to make custom cables for PC keyboards, peripherals.

Fig.	Positions	Cat. No.	Each
1	5	274-006	1.69
2	8	274-027	1.99

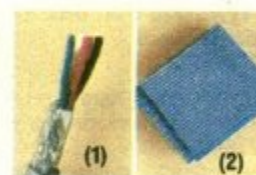

Multiconductor Cable

(1) **4-Conductor, Dual Shielded.** 30 feet. 278-777 7.95

(2) **Nonshielded Ribbon Cable.** 25-cond., 5 feet. 278-772 3.59

36-Cond. 6 ft. 278-774 .. 4.69

(3) **NEW!** 3¹/₂ and 5¹/₄" Disk Drive Adapter. 278-765 .. 2.49

10" Disk Drive Cable. 10" extension. 278-767 2.49

NEW! Power "Y". 278-766, 2.99

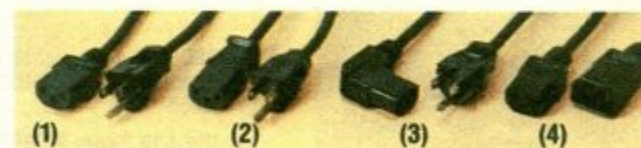

Grounded, UL Listed Computer AC Cords

(1) **6-Foot Shielded Cord.** 278-1262 4.99

(2) **6-Foot CEE Cord.** 278-1257 3.99

(3) **6-Foot Cord with Right-Angle CEE Connector.** For tight spaces. 278-1260 5.99

(4) **6-Foot CEE Extension.** 278-1259 4.99

12-Foot CEE Cord. 278-1261 5.99



Six-Foot AC Power Cords

(1) **Replacement Cord.** 278-1255 1.19

(2) **3-Prong Plug.** 10A/125VAC. 278-1258 2.99

(3) **Recorder/Radio.** Fits most models. 278-1254 2.49

Recorder/Radio. Similar to Fig. 3. 278-1256 1.99

Transistors and more

TO-220



TO-92



TO-39



TO-3



Replacements for 60,000 Transistor Types in Stock

Each transistor includes data and pin-out diagram. Refer to our *Semiconductor Reference Guide* (described at right) for complete data and cross-reference listings. Many other types are available on fast special-order.

Direct Commercial Equivalent	Replaces*			Pol.	Use	Diss.	Case	Cat. No.	Each
	GE†	Sylvania‡	RCA†						
	Type GE	Type ECG	Type SK						
MPS2222A	20	123A	3122	NPN	GP	500mW	TO-92	276-2009	.59
MPS3904	20	123A	3122	NPN	SW	350mW	TO-92	276-2016	.59
TIP31	66	152	3054	NPN	P	40W	TO-220	276-2017	.99
TIP3015	241	130	3027	NPN	P	90W	TO-220	276-2020	1.59
MPS2907	82	159	3025	PNP	SW	400mW	TO-92	276-2023	.59
MJEF34	34	197	3084	PNP	P	90W	TO-220	276-2027	1.49
2N3053	241	128	3024	NPN	P	5W	TO-39	276-2030	.79
TIP120	...	261	3180	NPN	D	65W	TO-220	276-2068	1.29
2N3055	14	181	3027	NPN	P	115W	TO-3	276-2041	1.99
MJ2955	74	219	3335	PNP	P	150W	TO-3	276-2043	1.99
2N4401	20	123AP	3444	NPN	SW	350mW	TO-92	276-2058	.49

N-Channel Field-Effect Transistors (FETs)

Direct Commercial Equivalent	Use.	Diss.	gfs min/max mhos	Case	Cat. No.	Each
2N3819	GP	360mW	2.0/6.5	TO-92	276-2035	.79
MPF102	VHF Amp/Mixer	310mW	...	TO-92	276-2062	.79

*Replaces in most circuits. See product package for device's exact specs.
D = Darlington P = Audio Amp, Switch NOTE: Parameters are at 25°
GP = General Purpose SW = Switch

Heat Sinks and Mounting Hardware

- (1) **TO-220 Heat Sink.** Designed for power semiconductors mounted on a printed circuit board. **276-1363** **89¢**
- (2) **Mounting Hardware.** A "must" for properly mounting power semiconductors in a TO-3 case. Includes screws, insulating washers, solder lug and brass bushings. **276-1371** **Set 99¢**
- Mounting Hardware for TO-220 Case.** Includes mica insulator, fiber washer screw and hex nut. **276-1373** **Set 99¢**
- (3) **Heat Sink Grease.** Assures proper heat transfer. 6.5 grams. **276-1372** **1.59**

TV Horizontal Output Transistor and Power MOSFET

- (4) **2SC1308.** High-voltage NPN transistor used as horizontal output in many color TV sets. Replaces ECG-238, GE-38 and SK-3115. TO-3 case. **276-2055** **6.95**
- (5) **IRF-510 Power MOSFET.** N-channel device is ideal for switching power supplies and power inverters, relay drivers and motor controllers, even in experimental RF and audio power amplifiers. High immunity to thermal runaway. Easily paralleled. Handles up to 60VDC, 3 amps. "On" resistance only 0.6 ohm. TO-220. **276-2072** **1.99**

Wire Wrapping — The Fast Way to Build Circuits

- (6) **Wire-Wrapping Tool.** Strips, wraps and unwraps 30-gauge wire. **276-1570** **6.95**
- (7) **Wire-Wrapping Posts.** These 0.025" square metal posts insert and securely lock into holes on perforated boards. **276-1987** **Pkg. of 20/99¢**
- (8) **30-Gauge Wire for Wire Wrapping.** 50 feet. **Each 2.39**

Color	Cat. No.	Color	Cat. No.	Color	Cat. No.
Red	278-501	White	278-502	Blue	278-503

- (9) **Wire Wrapping DIP IC Sockets.** Square 0.025" posts accept three levels of wrap.

Pins	Cat. No.	Price	Pins	Cat. No.	Price
8	276-1988	2/1.39	16	276-1994	2/1.69
14	276-1993	2/1.59	28	276-1983	Ea. 1.39

Books for Service Techs, Builders and Students

Engineer's Mini-Notebook Series. By Forrest Mims III. Valuable circuit data and interesting projects presented in the friendly style that Mims made famous—big, easy-to-follow diagrams and concise hand-lettered text.

Subject	Pages	Cat. No.	Price
Science Projects	48	276-5018	1.49
Timer ICs	32	276-5010	.99
Optoelectronics	48	276-5012	1.49
Basic Circuits	48	276-5013	1.49
Op Amps	48	276-5011	1.49
Digital Logic Circuits	48	276-5014	1.49
Communications	48	276-5015	1.49
Formulas, Tables	48	276-5016	1.49
Schematic Symbols	48	276-5017	1.49

Semiconductor Reference Guide. Lists over 95,000 semiconductor types and the replacements stocked at your nearby Radio Shack. Also provides detailed data on our ICs, modules, LEDs, SCRs and diodes. **276-4015** **3.99**

See us first for

Linear ICs for Projects and Replacement

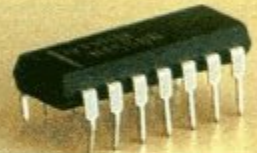

- TLC555 Low-Power CMOS Timer.** Same pinout as 555. Operates to 2 MHz. 8-pin DIP. **276-1718** **1.39**
- 555 Timer.** 8-pin DIP. **276-1723** **1.19**
- 556 Dual Timer.** 14-pin DIP. **276-1728** **1.49**
- LM386 Audio Amp.** Popular in projects. Low-distortion 400 milliwatt output. For 8-ohm load. 4-12VDC operations. 8-pin DIP. **276-1731** **1.09**
- 741 Op Amp.** Popular general-purpose operational amplifier. Overload protected. Frequency compensated. 8-pin DIP. **276-007** **79¢**

4000-Series CMOS Digital ICs

■ Factory-fresh ■ The best you can buy

Description	Type	Cat. No.	Each
Quad 2-Input NOR Gate	4001	276-2401	.99
Quad 2-Input NAND Gate	4011	276-2411	.99
Dual Type-D Flip-Flop	4013	276-2413	1.19
Decade Counter/Divider	4017	276-2417	1.49
Inverting Hex Buffer	4049	276-2449	1.19

Many other digital integrated circuits are available through Radio Shack's CMC special-order service. Details in any of our locations.

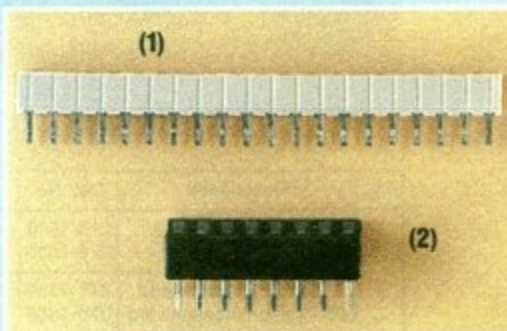



Getting Started in Electronics. Learn as you build! A super "hands on" introduction to assembling your own electronic circuits. 128 pages. **276-5003** **2.99**

Building Power Supplies. Explains how switching and linear power supplies work and provides complete plans for building five useful supplies with Radio Shack parts. 92 pages. **276-5025** **4.95**

integrated circuits

- 1458 Dual Op Amp.** 8-pin DIP. **276-038** **99¢**
- LM324 Quad Op Amp.** 14-pin DIP. **276-1711** ... **1.29**
- TL082 Dual BiFET Op Amp.** Low-noise, high impedance inputs. 8-pin DIP. **276-1715** **1.89**
- LM339 Quad Comparator.** Four voltage comparators in a 14-pin DIP. **276-1712** **99¢**
- LM3909 LED Flasher.** Flashes an LED with a minimum of support parts. Operates with a single-cell (1.5VDC) power source. Has many other possible uses—great for projects. 8-pin DIP. **276-1705** **1.69**
- MC1488 Quad Line Driver.** Useful for connecting computers and remote terminals using economical twisted pair wiring. 14-pin DIP. **276-2520** ... **1.29**
- MC1489 Quad Line Receiver.** Companion for quad line driver. Can provide multiple outputs and perform logic-level translation. 14-pin DIP. **276-2521** ... **1.29**

7400-Series TTL Digital ICs

■ Manufacturer's best ■ Top quality at low cost

Description	Type	Cat. No.	Each
Quad 2-Input NAND Gate	7400	276-1801	.89
Hex Inverter	7404	276-1802	.99
BCD to 7-Segment Driver	7447	276-1805	1.69
Div. by 2 or 5 BCD Counter	7490	276-1808	1.19

Hundreds of other ICs are available fast! Ask our manager about CMC special-order service.

Board-Mount IC Sockets

- (1) **20-Position SIP Socket.** Accepts single-inline pin devices. **276-1975** **1.49**
- (2) **Nonwicking Solder-Type DIP Sockets.**

No. of Pins	Cat. No.	Price
8	276-1995	Pkg. of 2/ .59
14	276-1999	Pkg. of 2/ .89
16	276-1998	Pkg. of 2/ .99
18	276-1992	Each .49
20	276-1991	Each .59
28	276-1997	Each .89
40	276-1996	Each .99

Diodes and regulators

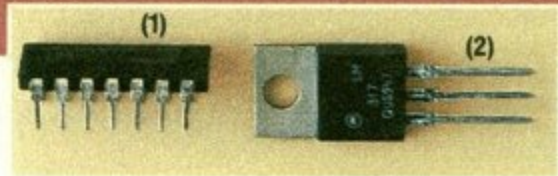

Adjustable Voltage Regulators

- (1) **LM723.** Adjustable 2 to 37VDC output. 150 mA maximum. 14-pin DIP. **276-1740** **99¢**
- (2) **LM317T.** Adjustable 1.2 to 27VDC output. Heat sink such as our #276-1363 is required for maximum current rating of 1.5 amps. TO-220 case. **276-1778** **1.99**

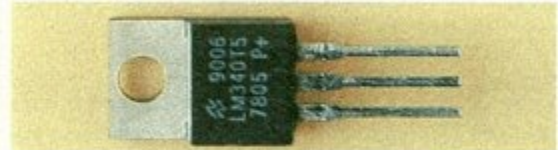

Fixed-Voltage Regulator ICs

Feature built-in overload protection and thermal shutdown. Maximum input: 35VDC. Heat sink such as our #276-1363 is required for full 1-amp current rating. TO-220 case style.

Type	Output VDC	Cat. No.	Each
7805	+5	276-1770	1.19
7812	+12	276-1771	1.19

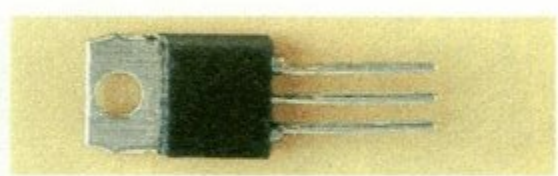

SCRs and Triacs

- 6-Amp Silicon Controlled Rectifiers (SCRs).**
- 200 Volts. **276-1067** **99¢**
- 400 Volts. **276-1020** **1.19**
- 6-Amp Triac.** Ideal for light dimmers, heating element control. Rated up to 400 volts. **276-1000** **1.49**

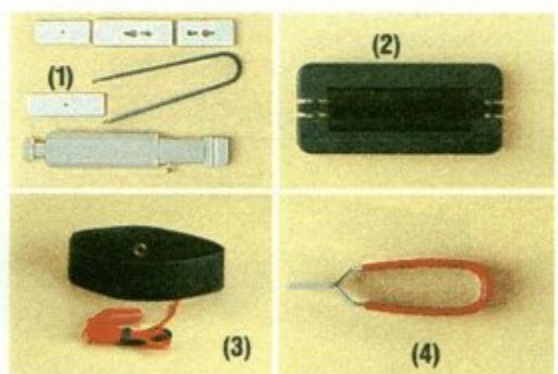

Tools for Safe IC Handling

- (1) **IC Inserter/Extractor Set.** Install and remove 6-pin to 40-pin DIPs without damaging them. Extractor works with LSI, MSI and DIP devices. Both tools are groundable to prevent static damage. **276-1581** **6.95**
- (2) **IC Pin Aligner.** With just a squeeze, bent pins become factory-straight. For 6-pin to 40-pin DIPs. Groundable. **276-1594** **3.49**
- (3) **Static-Draining Wrist Strap.** Has 24" ground lead with clip. **276-2397** **3.29**
- (4) **Soldering Heat Sink.** Solder semiconductors and low-power passive devices without damage. **276-1567** .. **1.19**

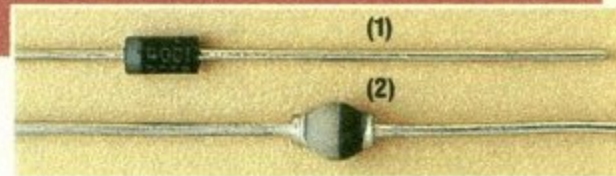

Top-Quality Rectifier Diodes

- (1) **Micro-Mini 1-Amp Diodes.** Rated 30-amp surge.

Type	Peak Inverse Voltage (PIV)	Cat. No.	Pkg. of 2
1N4001	50	276-1101	.49
1N4003	200	276-1102	.59
1N4004	400	276-1103	.69
1N4005	600	276-1104	.79

- (2) **3-Amp "Barrel" Diodes.** Rated 200 amps surge.

Type	PIV	Cat. No.	Pkg. of 2
1N5400	50	276-1141	.99
1N5402	200	276-1143	1.19
1N5404	400	276-1144	1.29

PTC205 2.5-Amp, 1000 PIV Silicon Diodes. Excellent choice for high-voltage, high-current power supplies. 1/4 x 3/16". **276-1114** **Pkg. of 3/1.49**

1-Watt Zener Diodes

Type	Voltage	Cat. No.	Each
1N4733	5.1	276-565	Pkg of 2/89¢
1N4735	6.2	276-561	Pkg of 2/89¢
1N4739	9.1	276-562	Pkg of 2/89¢
1N4742	12.0	276-563	Pkg of 2/89¢
1N4744	15.0	276-564	Pkg of 2/89¢

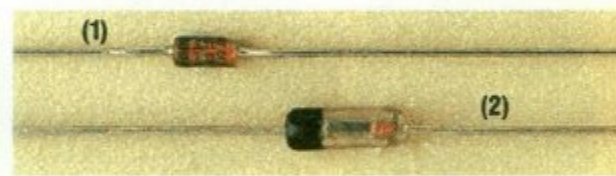
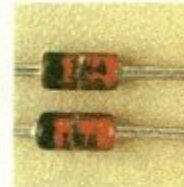

Switching and Signal Diodes

- (1) **1N914/4148.** Popular silicon switching diode. 75 PIV. **276-1122** **Pkg. of 10/99¢**
 - (2) **1N34A.** Hard-to-find general-purpose germanium signal diode. 60 PIV **276-1123** **Pkg. of 10/99¢**
- Radio Shack can supply a wide variety of switching, rectifier and signal diodes through our special-order "Hotline" service. See details on page 125.

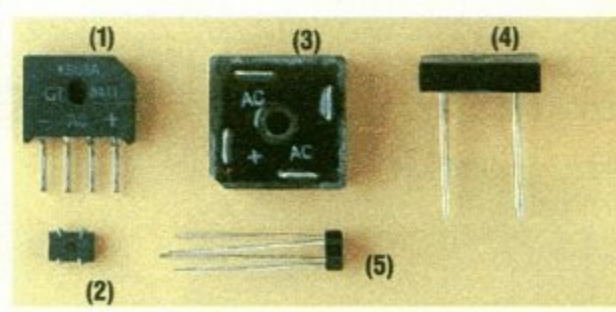

Full-Wave Bridge Rectifiers

- (1) **4-Amp Bridge Rectifiers.**

PIV	Cat. No.	Each
50	276-1146	1.39
100	276-1171	1.59
400	276-1173	1.99

- (2) **1-Amp, 50 PIV.** DIP-style. Two fit into a 14-pin DIP socket. **276-1161** **89¢**
- (3) **25-Amp, 50 PIV.** Metal case for maximum heat dissipation. Center mounting hole. **276-1185** **2.69**
- (4) **8-Amp, 250 PIV.** Mtg. hole. **276-1181** **2.19**
- (5) **1.5-Amp, 100 PIV.** **276-1152** **1.19**

Big selection of opto devices and enclosures

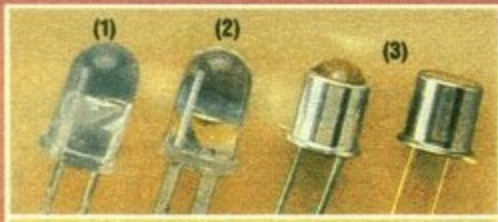

- (1) SYIR53L Infrared LED. 3.4mW typical output at 20 mA. 276-143 1.69
- (2) SY32PT Infrared Phototransistor. High-speed. 100 mW. T-1 $\frac{3}{4}$ size. 276-145, 99¢
- (3) Infrared Pair. Matched IR LED and a phototransistor detector. 276-142, Set 1.99
- (4) Infrared Sensor Card. Detects normally invisible infrared. Confirms output from remotes, IR LEDs or lasers. 276-099 .. 5.95

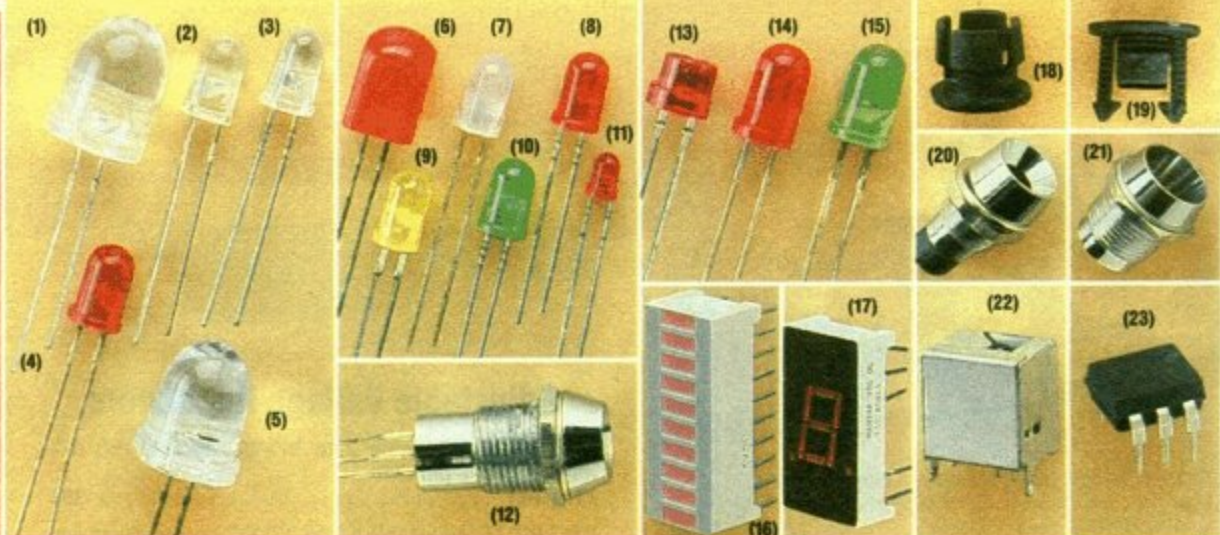

Check These Values in LEDs, Displays, and Infrared Detector Module

- (1) Jumbo 5000 mcd Red. Big and bright. 10 mm size. 276-086, 4.99
- (2) 2000 mcd Red. Brilliant! 20 mA at 1.85VDC. 276-087 1.69
- (3) High-Brightness Red. 500 mcd at 20 mA, yet runs cool. T-1 $\frac{1}{4}$ size. 276-066 1.19
- (4) Low-Current Red. Rated 2 mA. T-1 $\frac{1}{4}$ size. 276-044 89¢
- (5) Blinking High-Brightness Red. 3 Hz. GaAlAs. 10 mm. 276-020, 3.99
- (6) Tombstone Red. Easily stacked. Ideal for moving sign displays. 30 mA at 2VDC. 8 mm. 276-046, 99¢
- (7) Dual-Color. Provides orange or green output. 276-012 1.19

- Jumbo LEDs. Popular T-1 $\frac{3}{4}$ size.**
- | Fig. | Output | Cat. No. | Pkg. of 2 |
|------|--------|----------|-----------|
| 8 | Red | 276-041 | .69 |
| 9 | Yellow | 276-021 | .79 |
| 10 | Green | 276-022 | .79 |
- (11) Mini Reds. 276-026, 2/69¢
 - (12) Dual-Color. Provides red or green output. 276-025 1.49
 - (13) TLR-107 Brilliant Reds. Mini size. 276-033 Pkg. of 2/89¢
- Blinking LEDs. 1 Hz. T-1 $\frac{3}{4}$ size.**
- | Fig. | Output | Cat. No. | Each |
|------|--------|----------|------|
| 14 | Red | 276-036 | 1.29 |
| 15 | Green | 276-030 | 1.29 |
- (16) 10-Seg. LED Bargraph Display. 20-pin DIP. 276-081, 2.99

- (17) 7-Segment LED Digital Display. Common cathode, right decimal. 14-pin DIP. 276-075 .. 1.79
- Snap-In Holders for LEDs.**
- | Fig. | Accepts | Cat. No. | Pkg. of 5 |
|------|-------------------|----------|-----------|
| 18 | T-1 | 276-078 | .59 |
| 19 | T-1 $\frac{3}{4}$ | 276-079 | .59 |
- Deluxe Chromed LED Holders.**
- | Fig. | Accepts | Cat. No. | Price |
|------|-------------------|----------|--------|
| 20 | T-1 $\frac{3}{4}$ | 276-080 | 2/1.19 |
| 21 | 10 mm | 276-063 | 1.49 |
- (22) Infrared Detector Module. It's the heart of a remote-control project. Easy-to-use 3-lead device is $\frac{5}{8}$ " high. 5VDC. 276-137, 3.49
 - (23) MOC3010 Optocoupler. Ideal interface. 6-pin. 276-134 .. 1.99

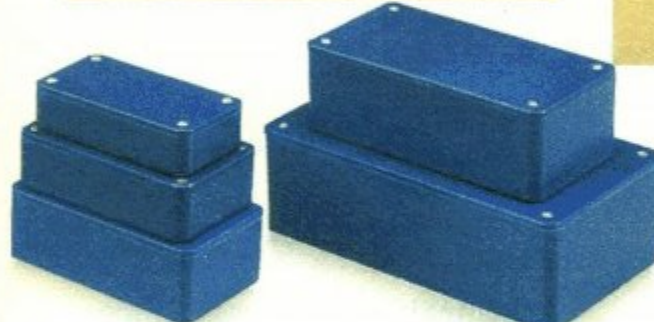

Popular Experimenter Enclosures

■ With internal slots for mounting a PC board

Overall Size	Cat. No.	Each
4 x 2 x 1 $\frac{3}{16}$ "	270-220	1.99
4 x 2 $\frac{7}{16}$ x 1 $\frac{1}{16}$ "	270-221	2.29
4 $\frac{3}{4}$ x 2 $\frac{1}{2}$ x 1 $\frac{1}{16}$ "	270-222	2.59
6 x 3 $\frac{3}{16}$ x 1 $\frac{7}{8}$ "	270-223	3.19
7 $\frac{1}{2}$ x 4 $\frac{1}{4}$ x 2 $\frac{1}{4}$ "	270-224	3.49



Boxes With Aluminum Covers

■ Easy-to-drill cover ■ Excellent for projects

Overall Size	Cat. No.	Each
3 $\frac{1}{4}$ x 2 $\frac{1}{8}$ x 1 $\frac{1}{8}$ "	270-230	1.89
4 x 2 $\frac{1}{8}$ x 1 $\frac{5}{8}$ "	270-231	2.19
5 $\frac{1}{16}$ x 2 $\frac{5}{8}$ x 1 $\frac{5}{8}$ "	270-233	2.39
6 $\frac{1}{4}$ x 3 $\frac{3}{4}$ x 2"	270-627	2.79
7 $\frac{3}{4}$ x 4 $\frac{3}{4}$ x 2 $\frac{3}{8}$ "	270-232	3.69



Power Supply Case

Well-vented, it's perfect for a small power supply or other heat-producing project. It has elevated mounting posts ($\frac{3}{32}$ " centers) for a transformer, plus a drop-in mount for adding a 2 $\frac{1}{8}$ x 1 $\frac{13}{16}$ " PC board. Two cable holes with strain relief. 2 $\frac{1}{2}$ x 4 $\frac{5}{8}$ x 3 $\frac{1}{4}$ ". With hardware. 270-287 3.99

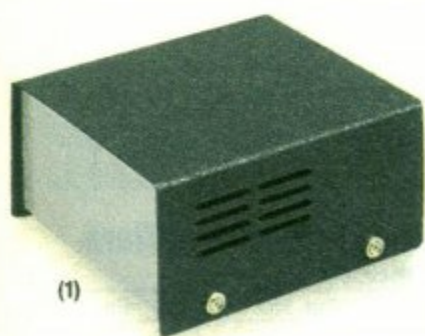

Metal Cabinet and "Beeper" Cases

- (1) Metal Cabinet. Has vented top, easy-to-drill aluminum front, back and bottom. 3 x 5 $\frac{1}{4}$ x 5 $\frac{7}{8}$ ". 270-253 ... 6.99
- (2) Transmitter Case. Has removable end panel and compartment for 9V battery. 1 x 2 $\frac{5}{16}$ x 3 $\frac{3}{4}$ ". 270-293, 3.99
- (3) **NEW!** Infrared Transmitter Project Case. Perfect for a remote or other small device. Removable end panel, compartment for 9V battery, card guides for PC board. Strong molded material. 7 $\frac{7}{8}$ x 2 $\frac{3}{8}$ x 4 $\frac{1}{4}$ ". 270-294 4.49

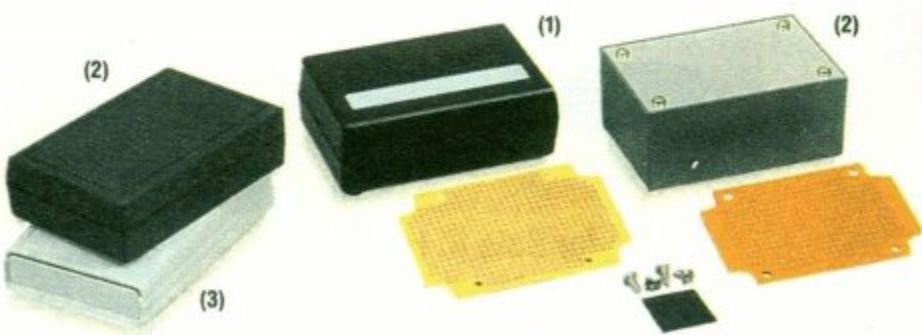

Box and PC Board Combos

- (1) Archer PERFBX[®] Circuit Box. Just add your circuit. Includes predrilled 2 x 3 $\frac{1}{8}$ " board. The molded enclosure is 3 $\frac{7}{16}$ x 2 $\frac{5}{16}$ x 1 $\frac{3}{16}$ ". Complete with labels, protective feet and assembly hardware. 270-291 4.99
- (2) Project Box With PC Board. Little box, big value! Handsome gray enclosure with an easy-to-drill aluminum cover. 3 $\frac{3}{16}$ x 2 $\frac{1}{8}$ x 1 $\frac{3}{8}$ ". Includes predrilled PC board, assembly hardware and protective feet. 270-283 3.99

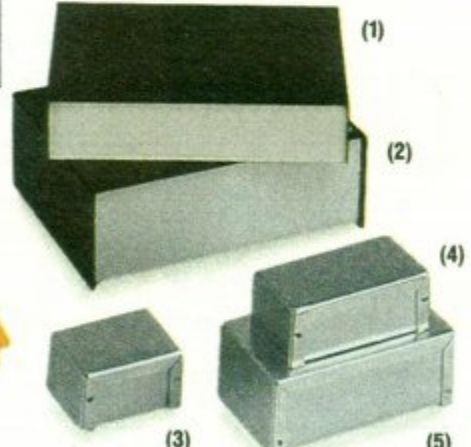

Metal Project Enclosures

- (1) 1 $\frac{5}{16}$ x 8 $\frac{1}{4}$ x 6 $\frac{1}{8}$ " Steel Box. With assembly hardware. 270-272 .. 8.99
 - (2) 3 $\frac{1}{16}$ x 8 $\frac{1}{4}$ x 6 $\frac{1}{8}$ " Steel Box. With assembly hardware. 270-274 .. 10.99
- Aluminum P-Box[®] Enclosures.**
- | Fig. | Size | Cat. No. | Each |
|------|---|----------|------|
| 3 | 2 $\frac{3}{4}$ x 2 $\frac{1}{8}$ x 1 $\frac{5}{8}$ " | 270-235 | 1.89 |
| 4 | 4 x 2 $\frac{1}{8}$ x 1 $\frac{5}{8}$ " | 270-239 | 2.19 |
| 5 | 5 $\frac{1}{4}$ x 3 x 2 $\frac{1}{8}$ " | 270-238 | 2.59 |

America's choice in multimeters! No other retailer sells more

A multimeter is a "must" for electronics repair work and project building. Micronta®-brand testers are designed to give you the very best combination of features and reliability. Each is quality tested and passes the UL 1244 safety standards set by Underwriters Laboratories.



(1)



(2)



(3)



(4)



(5)



(6)



(7)

Our analog-type multimeters are famous for high accuracy and excellent value



(8)



(9)

(1) **Clamp-On AC Ammeter.** Measures AC amps without direct hookup, AC volts with its probes. There's nothing better for checking heating/air conditioning systems, appliances and loads. Lockable pointer. Measures to 300 amps AC (5 ranges), 600 VAC (2 rgs.). **22-161, 49.99**

(2) **10-Megohm FET-Input Multimeter.** Works like a VTVM. 5" scale, continuity buzzer, battery check. Input fuse. Has 1V and 100 μ A DC ranges. Measures to 1000 VDC (7 ranges), 1000 VAC, 10 amps DC, 100 megohms resistance, -20 to +62 decibels (5 ranges each). **22-220, 49.99**

(3) **Range-Doubler Multimeter.** Continuity. 125 mV, 25 μ A DC ranges. Test to 1000 VDC (12 rgs.), 1000 VAC, -20 to +62 dB (8 rgs. ea.), 10A DC (10 rgs.), 20M Ω (4 rgs.). **22-214, 39.99**

(4) **Fold-Up Multimeter.** Ideal for field work. Movement is shunt protected when shut. Display angle adjusts. Has 600 mV and 60 μ A DC ranges. Measures to 1200 VDC (7 ranges), 1200 VAC, -20 to +62 dB (5 ranges each), 300 mA DC (4 ranges), 2 megohms (4 ranges). **22-211, 29.99**

(5) **NEW! "Home" Tester.** Multimeter, phone line tester, AC outlet tester and battery tester in one! Nothing else needed to test AC sockets, single and dual-line phone jacks, 9V, D, C, AA, AAA, N and button cells. Measures to 1000 volts AC/DC (3 rgs. ea.), 100k Ω . **22-213, 24.99**

(6) **NEW! 18-Range Multimeter.** Features 3" meter with mirrored scale. Measures to 1000 VDC (5 ranges), 1000 VAC (4 rgs.), 250 mA DC (2 ranges), 2 megohms (3 ranges). **22-221, 19.99**

(7) **Pocket-Size Multimeter.** Basic features, handy size, low cost. One of our most popular. Measures to 1000 volts AC/DC (3 ranges each), 150 mA DC and 100k Ω . **22-212, 12.99**

(8) **Battery Tester.** Accurate, tests under load. Checks virtually all common types: 1.5V (3 ranges), 3, 6, 9, 12, 22.5V. 1 $\frac{3}{4}$ " x 3 $\frac{1}{2}$ " x 5 $\frac{1}{4}$ ". For battery tests only. **22-032 12.99**

(9) **NEW! Plug-In AC Line Voltage Monitor.** Incorrect voltage can damage sensitive equipment. Has easy-to-read 96-to-130 VAC expanded scale. Accuracy \pm 2%. **22-104, 12.99**

Fig.	Cat. No.	DC Sensitivity	Size	Batteries Required
1	22-161		4 x 2 x 3/8"	None
2	22-220	10 megohms	7 $\frac{1}{16}$ x 5 $\frac{1}{2}$ x 2 $\frac{3}{4}$ "	9V, "C"
3	22-214	50,000 Ω per Volt	6 $\frac{1}{16}$ x 4 $\frac{7}{8}$ x 2 $\frac{3}{8}$ "	9V, "AA"
4	22-211	20,000 Ω per Volt	7 $\frac{1}{4}$ x 4 $\frac{15}{16}$ x 1 $\frac{1}{4}$ "	"AA"

Fig.	Cat. No.	DC Sensitivity	Size	Batteries Required
5	22-213	2000 Ω per Volt	6 $\frac{7}{8}$ x 3 $\frac{1}{2}$ x 1 $\frac{3}{8}$ "	"AA"
6	22-221	20,000 Ω per Volt	5 $\frac{3}{16}$ x 3 $\frac{1}{2}$ x 1 $\frac{1}{2}$ "	"AA"
7	22-212	2000 Ω per Volt	3 $\frac{1}{2}$ x 2 $\frac{1}{4}$ x 1 $\frac{7}{16}$ "	"AA"



Tester "How to" Book

Using Your Meter. Get the most from your tester. Easy-to-understand book explains how multimeters work and how to test all sorts of electronic circuits, household appliances and wiring. Illustrated. 128 pages. **62-2039, 4.95**

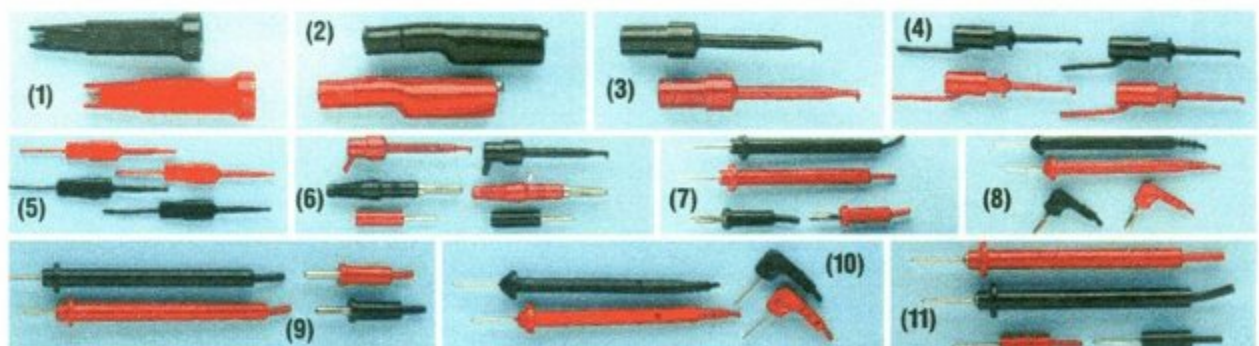

Accessories to Make Your Multimeter Even More Versatile

(1) **Wire-Piercing Probe Adapters.** Slip over probe tips. Pierces insulation to make contact with wire. **278-715 . . . Pair/2.99**

(2) **Alligator Clip Adapters.** Slip over probe tips. Great for attaching test probes to test points and terminals. **270-354, Pair/1.99**

(3) **Mini-Hook Adapters.** Slip over probe tips. Ideal for attaching test probes to component and IC leads. **270-334 . . . Pair/2.59**

(4) **Mini-Clip Jumper Wires.** 20" long. **278-016 . . . Pair/3.99**

(5) **Micro-Clip Jumper Wires.** 20" long. **278-017 . . . Pair/3.49**

(6) **Mini-Clip Test Leads.** 48" long. Clip at one end. Banana plug at other. With pin-tip adapters. **278-1160 Pair/4.19**

(7) **Coiled 6-Ft. Test Leads.** Test probe at one end. Banana plug at the other. Coiled to help prevent tangles. **278-750, Pair/4.99**

(8) **Test Leads With 90° Pin Tips.** 36" long. **278-712, Pair/2.49**

(9) **Test Leads With Banana Plugs.** 30". **278-704 . . . Pair/3.19**

(10) **Test Leads With 90° Banana Plugs.** 36". **278-713, Pair/3.19**

(11) **Test Leads With Pin Tips.** 36" long. **278-705 . . . Pair/1.99**

Our largest-ever selection of LCD digital multimeters

Extra functions and top quality at low prices—compare!



(1) **NEW!** Handheld True RMS Autoranging/Manual. What a value! True RMS readings on AC volts and current. Frequency counter to 4 MHz, dBm measurement, capacitance from 4 nF to 400 μF, 40-dot bargraph, transistor gain, even a temperature probe with C°/F° scales. 22-174 89.99



(2) **NEW!** Benchtop True RMS With Frequency Counter, Transistor Gain and Capacitance Ranges. True RMS for more accurate readings on non-sine wave AC. Autoranging/manual, bargraph, hold, min./max. memory, relative measurement, continuity, diode-check and dBm. 22-175 . . . 99.99



(3) With Capacitance and Transistor Gain Ranges. Low-resistance transistor and capacitor sockets, continuity buzzer, autopolarity. Measures to 1000 VDC, 750 VAC (4 ranges each), 10A AC/DC (4 rgs. each), 20 megohms (6 rgs.), 20 μF capacitance (5 rgs.) and NPN/PNP hFE. 22-194 . . . 79.99

New! Multimeter With PC Interface

(4) **32 Ranges.** Included PC-compatible cable and software on 3 1/2" disk allow you to log measurements. 41-dot bargraph, frequency counter to 200 kHz, continuity buzzer, transistor-gain and capacitor measurement, data hold, min./max. and auto power-off. 22-182, 129.99



(5) **Protective Holster, Autoranging/Manual, Bargraph.** The 33-dot bargraph helps you spot peaks and trends. You also get a handy low-current range—200 μA! Data hold switch freezes display. Features include autopolarity, battery-saving automatic shutoff, continuity buzzer, and diode-check mode to test semiconductor junctions without damaging the devices. Measures to 1000 VDC, 700 VAC, 10 amps AC/DC current and 30 megohms resistance. 22-167 . . . 69.99



(6) **Autoranging/Manual With Bargraph.** Fast-response 31-dot bargraph. Data-hold, continuity buzzer, diode-check mode, autopolarity operation. Measures to 1000 VDC, 750 VAC, 10 amps AC/DC, 30 megohms. 22-186 . . . 69.99



(7) **23-Range Manual.** Features continuity buzzer, diode-check mode, autopolarity. Measures to 1000 VDC (5 ranges), 750 VAC (4 ranges), 10 amps AC/DC current (4 ranges each), 30 megohms resistance (6 ranges). 22-185 . . . 59.99



(8) **Autoranging/Manual.** Continuity buzzer, diode-check mode, autopolarity. Measures to 1000 VDC, 750 VAC (5 ranges), 10 amps AC/DC current and 2 megohms resistance. Was \$59.95 in 1992 Catalog. 22-184, **New Low Price!** 49.99



(9) **NEW! Autoranging.** Convenient autoranging and autopolarity at a low price. Select the function, meter does the rest. Diode-check mode. Measures to 1000 VDC, 750 VAC, 200 mA DC current, 20 megohms resistance. 22-166, 36.99

(10) **Pocket-Size Autoranging/Manual.** Accurate, easy to use and take along. Continuity buzzer. Measures to 400V AC/DC and resistance. With case and two Radio Shack #23-115 batteries. 22-169 27.99

(11) **Pocket-Size Autoranging.** Folds, with probes, to easily fit a shirt pocket. Continuity buzzer, diode-check. Measures to 400 volts AC/DC, 2 megohms resistance. With case and two Radio Shack #23-115 batteries. 22-171 24.99



Fig.	Cat. No.	Size	Batteries Required
1	22-174	7 x 3 1/8 x 1 1/8"	6 "AA"
2	22-175	2 1/8 x 8 x 4 1/4"	6 "AA"
3	22-194	7 1/8 x 3 1/8 x 1 1/8"	9V
4	22-182	7 1/8 x 3 1/2 x 1 1/8"	9V
5	22-167	7 1/2 x 3 1/8 x 1 1/8"	2 "AA"

Fig.	Cat. No.	Size	Batteries Required
6	22-186	6 7/8 x 3 1/8 x 1 1/2"	4 "AA"
7	22-184	6 1/8 x 3 1/8 x 1 1/4"	4 "AA"
8	22-185	6 1/8 x 3 1/8 x 1 1/4"	4 "AA"
9	22-166	5 x 3 x 1 1/8"	2 "AA"
10	22-169	4 1/4 x 2 1/8 x 1 1/8"	Included
11	22-171	4 1/4 x 2 1/8 x 1 1/8"	Included

NOTE: All above have 10-megohm input sensitivity for high accuracy. Displays have over-range and low-battery indicators. All (except #22-169 and #22-171) are fuse protected. Spare fuse included. Multitesters, multimeters and AC ammeter are listed under UL 1244.

Introducing the new standard in precision tools—TECHLINE

Every TECHLINE™ tool represents an uncompromising dedication to quality. All are precision-crafted to provide superior strength and durability. In fact, we are so proud of the craftsmanship of TECHLINE tools that they all carry Radio Shack's 1-year limited warranty. For the very best, always choose TECHLINE.



New! Handy Bits-Selector by TECHLINE



Ideal for any busy technician on the go! Includes 10 assorted slotted, Phillips and Torx® bits on 1/4" hex, magnetic drive adapter/power tool extender and durable carry case. 64-1976 19.95



New! TECHLINE Swiss Army Knife

Like having a tool kit in your pocket! Versatile knife includes large cutting blade, Phillips and slotted screwdriver, wire stripper, utility can/bottle opener, mini pliers and wire cutter, tweezers and plastic toothpick. 64-2001 29.95

New! Archer® Cordless Screwdriver and Socket Set with Case and Charger



- Install and remove bolts and screws fast

One of the handiest tool kits you'll ever own! Fully rechargeable. Comes with steel screw bits, sockets, adapters, charger and molded storage case. 64-2401 31.95



Enervac® Cordless Vacuum

Easiest way to keep equipment clean! Goes anywhere and fits comfortably in your hand—only 9 1/4" long. Comes with brush and nozzle attachments, easy-to-clean filter. Has sliding on/off switch. Requires 4 "AA" alkaline batteries. 64-2504 9.95

New from TECHLINE

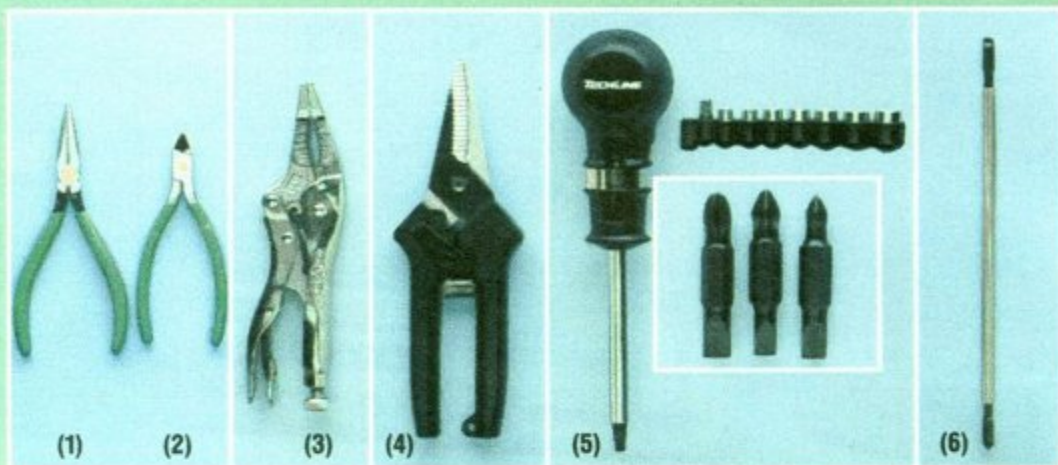

New! Professional-Grade Tools to Do It Right the First Time

- (1) **Thin Long-Nose Pliers.** Precision tip alignment. Spring-action, plastic grip. 64-1807, 12.99
- (2) **Diagonal Wire Cutter.** Copper alloy rivet with spring tension for smooth action, precision cutting. Insulated grip. 64-1808 12.99
- (3) **Bent-Nose Locking Pliers.** Nose set 45° from jaws, serrations for better grip. 64-1869 .. 12.99
- (4) **All-Purpose Snips.** Stainless steel spring and blades. Safety latch. 64-1983 ... 10.99
- (5) **13-Piece Ratchet Driver.** Innovative grip handle, 3 double-sided screwdriver bits, 7 standard sockets, adapter. 64-1978 .. 14.99
- (6) **Slotted/Phillips Screw Starter.** Holds screw for proper alignment. 64-1966 4.49



New! Hex Tool Sets and Mini Bar Clamp to Make Jobs Easier

- 18-Piece Hex Key Set.** Made of heavy duty steel alloy. Ideal for engine and machinery work. Standard sizes. 64-1816 4.99
- Six-Piece Ball-End Metric Hex Tools.** For hard-to-reach spots ordinary wrenches won't reach. 64-1818 5.99
- Ball-End Hex Keys.** 64-1817, 6.99
- Mini Bar Clamp.** Fast and quick way to clamp your projects. Sliding handle lets you make adjustment with only one hand. 64-1984 ... 14.99



New! Quality Tools for Special Applications and Precision Work

- Multi-Tip Screwdriver.** Eight sizes of regular, Phillips and Torx steel tips, stores in handle! Shank doubles as 1/4" nutdriver. 64-1967 9.99
- Four-Way Pocket Tool.** A reversible slotted and Phillips screwdriver. Double-ended handle serves as 7/16" and 1/4" nutdriver. 64-1968, 7.99
- Six-Piece Mini Driver Set.** Jeweler's type and Phillips screwdriver for detailed work. Color-coded handles, pouch. 64-1969 12.99



New! Five-Piece Mini Hand Drill is Ideal for All Kinds of Projects and Crafts

- Drill bits store conveniently right in the shank
- Superb TECHLINE quality. Easy to use—compact drill fits comfortably in the palm of your hand. Precision geared drive for smooth handle operation. Includes four standard drill bits, sizes: 3/32", 1/8", 5/32" and 3/16". 64-1979 12.99

Tools and accessories



You Can Depend on Archer® Tools

Six Great Ways to Get a Handle on Your Work

(1) **Deluxe 7-Piece Screwdriver Set.** Includes $\frac{1}{4} \times 1\frac{1}{2}$ " stubby, $\frac{1}{8} \times \frac{1}{4}$ " midget, $\frac{1}{4} \times 4\frac{1}{4}$ " mechanics' screwdriver, $\frac{3}{16} \times 4$ " and $\frac{3}{16} \times 6$ " cabinet, #1-2 Phillips. **64-1823 6.49**

(2) **Reversible Screwdriver.** Driver bar has a Phillips end and standard end. **64-1950, 2.99**

(3) **8-Piece Nutdriver Set.** Interchangeable. $\frac{1}{8}$ " to $\frac{3}{8}$ " sizes. **64-1800 6.49**

(4) **Locking Long-Nose Pliers.** Doubles as a wrench. 6" long. **64-1864 5.99**

(5) **Nibbling Tool.** cuts up to 18-gauge steel, $\frac{1}{16}$ " copper, aluminum, plastic. **64-823, 10.95**

(6) **Deluxe Crimping Tool Set.** Includes heavy-duty crimp tool, assorted terminals and plastic storage case. **64-409 10.95**

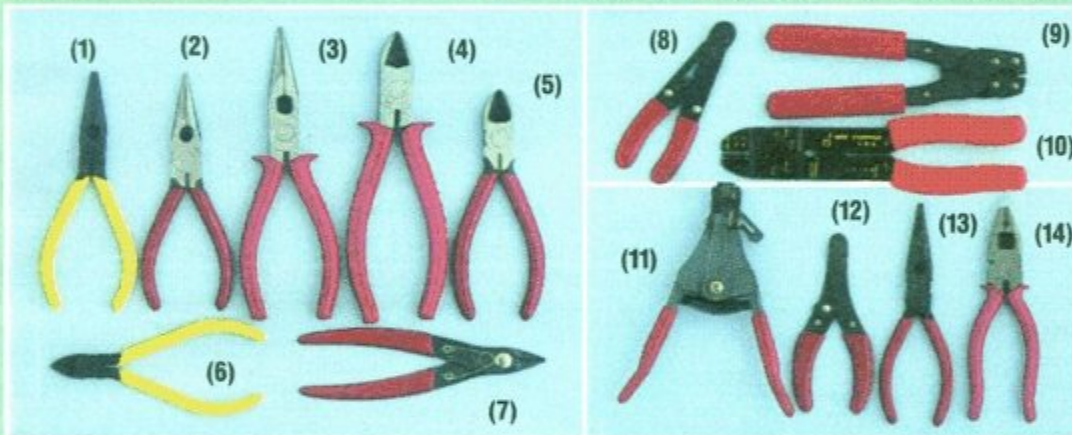

Make a Cut Above the Rest With These Wire Tools

(1) **5 $\frac{1}{4}$ " Long-Nose Pliers.** Spring-action. **64-1812 6.99**

(2) **4 $\frac{3}{4}$ " Long-Nose Pliers.** **64-1843 4.49**

(3) **6 $\frac{1}{2}$ " Long-Nose Pliers.** **64-1844 3.49**

(4) **6" Diagonal Cutters.** Comfortable, insulated grips. **64-1845 3.49**

(5) **4 $\frac{1}{2}$ " Diagonal Cutters.** **64-1841 4.49**

(6) **4 $\frac{1}{2}$ " Diagonal Cutters.** Spring-action. **64-1813 6.99**

(7) **5" Nippy Cutters.** **64-1833 3.79**

(8) **Wire Stripper/Cutter.** **64-2129 2.79**

(9) **Phone Installation Tool.** **64-410 7.79**

(10) **Crimping Tool.** Strips/cuts 10 to 22-gauge wire. **64-404 5.79**

(11) **Wire Stripper.** For 8 to 22-gauge. **64-1919 11.95**

(12) **"Dial" Wire Stripper.** **64-1952 4.29**

(13) **4-in-1 Long-Nose Pliers.** Built-in stripper, cutter, crimper and nut wrench. **64-1847, 4.99**

(14) **NEW! Electrician Pliers.** **64-1871 4.99**

Great Values in Tools & Tool Sets

(1) **16-Piece Precision Tool Set.** **64-1961, 10.95**

Precision Screwdrivers. **64-1948 4.29**

6-Piece Screwdriver Set. **64-1959 4.29**

Six Crosspoints. **64-1962 4.29**

Three Minidrivers. **64-1982 1.49**

(2) **5" Mini Forceps.** **64-1910 1.79**

(3) **Five-Piece Needle File Set.** **64-1985, 5.99**

(4) **Ten-Blade Knife Set.** **64-1801 4.79**

Multipurpose Hobby Knife. **64-1805 1.39**

(5) **Anti-Static TV Alignment Kit.** **64-2230, 4.39**

(6) **Two-Piece Television Color Alignment Kit.** **64-2223 99¢**

(7) **5-Piece TV Tool Kit.** **64-2220 2.99**

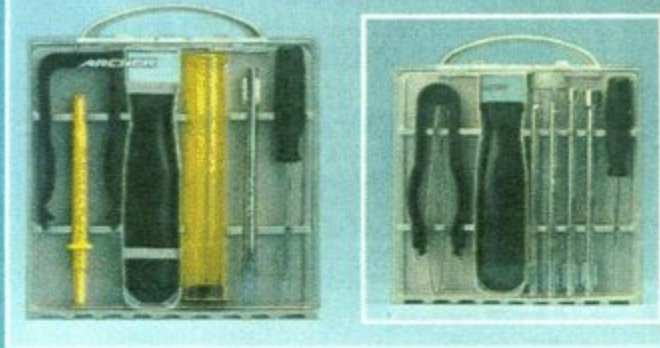

New! Compact 14-Piece PC Tool Kit

Just what you need to service your computer! Includes slotted and Phillips screwdrivers, chip extractor and inserter, nutdriver, tweezers, extra parts tube and carry case. **64-1972 . . . 14.95**

New! 100x Slide Microscope

Countless uses for students, professionals and hobbyists! Built-in light shines on object for easier viewing. Adjustable rotary focusing knob, non-slip molded body. Sturdy stand for steady, upright viewing. Powerful 100x lens with direct illumination for incredible detail. Includes six specimen slides and protective carry case. Requires 2 "AA" batteries. **63-853 12.95**



Mini Microscope and Magnifiers

(1) **30-Power Lighted Hand Microscope.** Magnifier with 8x power, case. Requires 2 "AA" batteries. **63-851 9.95**

(2) **Lighted Magnifier.** Dual magnification—2 $\frac{3}{4}$ " lens and inset 1" lens. Requires 2 "AA" batteries. **63-848 5.95**

(3) **Pocket Magnifier.** Just right for studying stamps, maps, schematics and more! Only 2 $\frac{1}{8}$ " square. **63-852 1.39**

Electronic STUDDINDER

No more guesswork! Locates exact center of wooden studs or metal frame. Hang shelves, pictures, or locate pipes, wiring and conduits. Automatically recalibrates. Requires 9V battery. **64-2825 . . . 24.95**



Ultrasonic Tape Measure

Just aim and read—measures area and distance. Computes figures, measure recall. Requires 4 "AAA" batteries. Was \$39.95 in 1992 Catalog. **63-645, 29.95**



Widest selection of soldering supplies... why shop elsewhere?

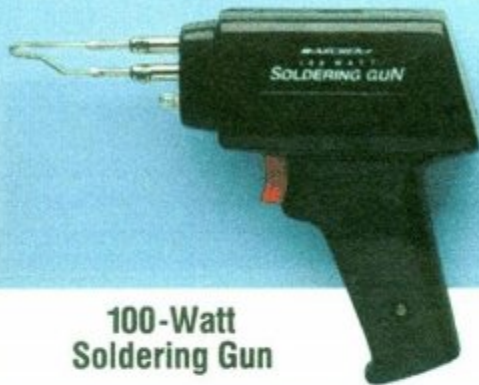

100-Watt Soldering Gun

What a value—and it makes soldering jobs so easy! Pull trigger and the tip reaches full temperature in just seconds. Has a built-in light to illuminate work. **64-2193** **11.95**

Extra Tips for Use With	Cat. No.	Pkg. of 2
Archer 64-2193/2192	64-239	1.89
Archer 64-2191	64-238	1.89
Weller D440, 8200 and Archer 64-2190	64-237	1.89
Weller D550	64-234	1.89



10-Piece Electronics Tool Set

This complete set is designed for kit builders and is excellent for precise light to medium-duty work. You get a 30-watt pencil soldering iron, stand, solder, soldering helper, pliers, diagonal cutter, three screwdrivers and heat sink.

64-2801 **16.95**



5-Piece Soldering Tool Set

Includes everything you need for basic soldering jobs. Iron, stand, rosin core solder, soldering helper, heat sink and instructions. **64-2802** **7.95**

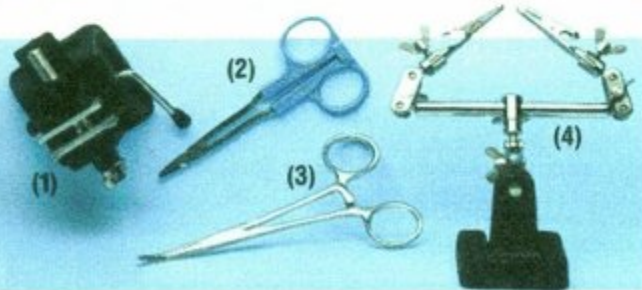

Extra "Hands" to Hold Your Work

- (1) Mini-Vise With Vacuum Base. Holds parts securely for on-the-spot soldering, gluing and drilling. **64-2094** **4.49**
- (2) Straight Mini Forceps. **64-1910** **1.79**
- (3) Locking Forceps. Stainless steel. **64-1866** **4.95**
- (4) Project Holder. Alligator-type clamps adjust to hold work in any position. Solid cast-iron base. **64-2093** **8.49**

Soldering tools



- Customize your iron the way you want
- Select from a variety of quality components



- Removes solder from components
- Easy-to-use one-hand operation

Desoldering made easy! Includes vacuum bulb and replaceable tip. 8" long. 5-foot cord. 45 watts. **64-2060** **8.49**

Replacement Tip. **64-2061** **99¢**
Heavy-Duty Desoldering Tip. **64-2062** **1.99**



Dual-Wattage Pencil Iron

Versatile! When you need more power, just flip the switch to go from 15 watts to 30 watts. **64-2055** **9.49**

Replacement Tip. **64-2065** **1.19**
Replacement Chisel Tip. **64-2056** **1.19**



Top-Quality AC and Mobile Soldering Irons

- (1) 15-Watt Pencil. Grounded tip. Ideal for IC work. **64-2051** **7.49**
Replacement Tip. **64-2052** **99¢**
- (2) 40-Watt Pencil. Just right for larger jobs. Produces 600-640° F. Has 1/4" screw-in tip. Includes safety stand. **64-2071** **7.49**
Replacement Tip. **64-2072** **1.29**
- (3) 25-Watt Pencil. Similar to Fig 2, but with 5/32" tip. **64-2070** **6.49**
Replacement Tip. **64-2073** **1.19**

- (4) 30-Watt Pencil. Lightweight, cool-grip handle. **64-2067** **4.79**
Replacement Tip. **64-2065** **1.19**
- (5) Mobile 30-Watt Pencil. 12VDC. Plugs into car lighter socket. Ideal for automotive accessory and stereo wiring jobs. **64-2105** **5.79**
Replacement Tip. **64-2072** **1.29**
- (6) 30-Watt Cool-Grip Gun. **64-2066** **5.49**
Replacement Tip. **64-2065** **1.19**
Iron-Clad Tip. **64-2058** **1.59**



Soldering and Desoldering Accessories

Fig.	Description	Cat.No.	Each
1	Soldering Iron Holder/Cleaner	64-2078	6.49
2	Desoldering Bulb	64-2086	2.69
3	4-Piece Set: Heat Sink, Brush/Scraper, Two Probes	64-2227	4.19
4	Tip Tinner/Cleaner	64-020	4.99
5	Desoldering Braid	64-2090	1.99
6	Desoldering Tool	64-2120	5.99
7	Vacuum Desoldering Tool	64-2098	5.99

Chemicals plus



Cleaning and Servicing Sprays

- (1) **Color-TV Tuner Cleaner.** Our special formula for color-TV mechanical tuners. 6 oz. 64-3320 ... 4.99
- (2) **TV Tuner Cleaner.** For "scratchy" volume and tone controls, too. 6 oz. 64-3315 ... 3.99
- (3) **Cleaner/Degreaser.** Sprays away dirt from circuits and components. 8 oz. 64-3322 ... 4.99
- (4) **Dust Remover.** Clean circuit boards, cameras, copiers and more. 6 oz. 64-3325 ... 4.99
- (5) **Component Cooler.** Spray on components to spot thermal defects. 6 oz. 64-3321 ... 4.99
- (6) **Rosin Flux Remover.** Removes soldering flux deposits from circuit boards. 6 oz. 64-3324 ... 3.99
- (7) **Anti-Static Spray Cleaner.** Repels dust by eliminating static build-up. 6 oz. 64-3310 ... 3.99
- Lubricant Protector Spray.** Penetrates to loosen rust and frozen parts. 0.75 oz. 64-1874 ... 1.99



- (1) **Lead-Free Solder.** 96% tin/4% silver. 0.032" diameter size. 0.25 oz. 64-025 ... 1.99
- Above in 0.062" Size. 0.5 oz. 64-026 ... 1.49
- (2) **Rosin Soldering Flux.** 1 oz. 64-021 ... 1.99
- (3) **Solder-Weld.** Silver-bearing paste. Use with lighter or iron. Ideal for RF hookups. 7.1 grams. 64-029 ... 2.69
- (4) **Solder Tape.** Solder with a match! Great for outdoor hookups, antenna work. Pkg. of 100 strips. 64-010 ... 1.49

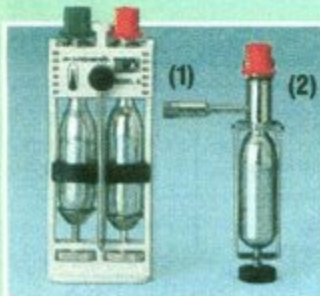

Pocket-Size Gas Torches

- For those on-the-run repair jobs requiring high, pinpoint heat

- (1) **Soldering/Brazing Torch.** Produces up to 5000° F in an adjustable pinpoint flame. With one butane and two micronox cylinders, two tips, storage tray. 64-2165 ... 27.95
- Extra Butane Cylinders. 64-2166 ... Pkg. of 2/3.99
- Extra Micronox Cylinders. 64-2167 ... Pkg. of 2/2.69
- (2) **Butane Torch.** Heats to 2500° F. For soldering, heating, removing paint. With one refill cylinder. 64-2164 ... 12.95

Make the Connection With the Right Solder

When you need to depend on a strong connection you need a solder you can depend on. We have a wide variety of solder, including high-grade silver solder—ideal for surface-mount devices. Come in today and find just what you need to get the job done.

(5) **Rosin Core Solder.** Standard 60/40 formula.

Size	Amount	Cat. No.	Each
.062"	0.5 oz.	64-001	.99
.062"	1.5 oz.	64-002	1.69
.062"	4.0 oz.	64-004	3.69
.032"	2.5 oz.	64-005	3.39
.050"	1.5 oz.	64-006	2.49
.062"	8.0 oz.	64-007	5.99
.062"	1 lb.	64-008	8.99
0.32"	8.0 oz.	64-009	6.49

Silver Solder. 62/36/2% formula. 0.022" size. 1.5 oz. 64-013 ... 2.99

Hi-Tech Solder. 63/37% formula. 0.050" size. 1.5 oz. 64-015 ... 2.49



Lube Gel & Precision Oiler

- Improved With Teflon™
- (1) **Lube Gel.** Perfect for hinges, sliding doors, tools and more. 3-oz. 64-2326 ... 2.79
- (2) **Precision Lubricator.** Needle tip applicator reaches hard-to-get-to places. 3/4 oz. 64-2301 ... 1.99

We stock those hard-to-find items...look and see!

When you want a job done right you've got to have the best tools...we feature our **TECHLINE™** and **Archer®** tools because you can depend on their superior quality every time. Each **TECHLINE** tool comes with a 1-year limited warranty.

Details in store



New! TECHLINE Rechargeable Soldering Gun

- Trigger lock prevents accidental turn-on
- Great for autos, boats and campers

Powered by Ni-Cd batteries, so you can do repair jobs quickly and easily—without having to find the nearest AC outlet. Solder 250 joints on a single charge. Trigger-activated light illuminates work. Ideal for quick jobs and hard-to-reach areas. Includes UL listed AC charging unit and carry case. 64-2194 ... 39.95.



New! TECHLINE Portable Gas-Powered Iron

- 4-in-1 convertible:
- Solderer
 - Blow torch
 - Hot knife
 - Heat blower
 - Guaranteed to last

(1) Provides up to 60 minutes of heating and it refills in seconds with standard butane lighter fuel. Adjustable output, equivalent to 10-60 watts. With 2.4mm tip. 64-2182 ... 34.95

Replacement Tips. Two sizes available. (1) 2.4mm, 64-2162 (CMC). 1mm, 64-2183 ... Each 9.95

Heat Blower, 64-2169, Hot Knife Tip, 64-2170, Blow Torch Tip, 64-2168. Special order (CMC) ... Each 9.95

(2) **Set of 4 Tips.** Value Pack. (CMC) 64-2171 ... 29.95

Put it together! Archer® adhesives, tapes and connectors make it easy



New! Super-Strength Tapes

- (1) **Electrical.** The very best! Features tough 7-mil backing. Flame retardant, moisture resistant, and withstands 0° to 220° temperatures. 3/4" x 66 ft. **64-2352** **2.99**
- (2) **Sealing Tape.** Jumbo 3.2 mil thickness and amazing strength. 2" x 60 ft. **64-2364** **4.49**

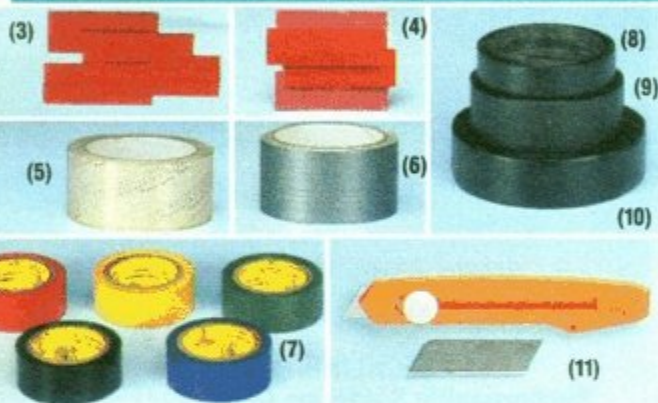

Electrical, Packaging and Sealing Tape

- (3) **NEW! Clear SUPERMOUNT™ Foam Tape.** Up to 3 times more holding power than standard double-sided tape. Ideal invisible bond when mounting objects on glass. Four 2 3/4" strips. **64-2362**, **2.49**
- (4) **NEW! Clear SUPERLOCK™ Fasteners.** Best choice for mounting items on nonporous surfaces. Four 3" strips. **64-2363** **2.99**
- (5) **Packaging Tape.** This high-strength tape seals out moisture. Big 2" x 165-foot roll. **64-2339** **2.49**
- (6) **All-Purpose Tape.** 2" x 30-ft. roll. **64-2347** **2.39**
- (7) **Electrical Tape Assortment.** Five 3/4" x 12-ft. rolls. Different colors, ideal for color-coding your hookups. **64-2340** **2.29**
- (8) **PVC Electrical Tape.** 1/2" x 12 1/2-ft. roll. **64-2348** **59¢**
- (9) **PVC Electrical Tape.** 3/4" x 20-ft. roll. **64-2349** **89¢**
- (10) **PVC Electrical Tape.** 3/4" x 66-ft. roll. **64-2350** **1.49**
- (11) **6" Utility Knife.** Snap off blade end for new edge. **64-1868**, **1.39**

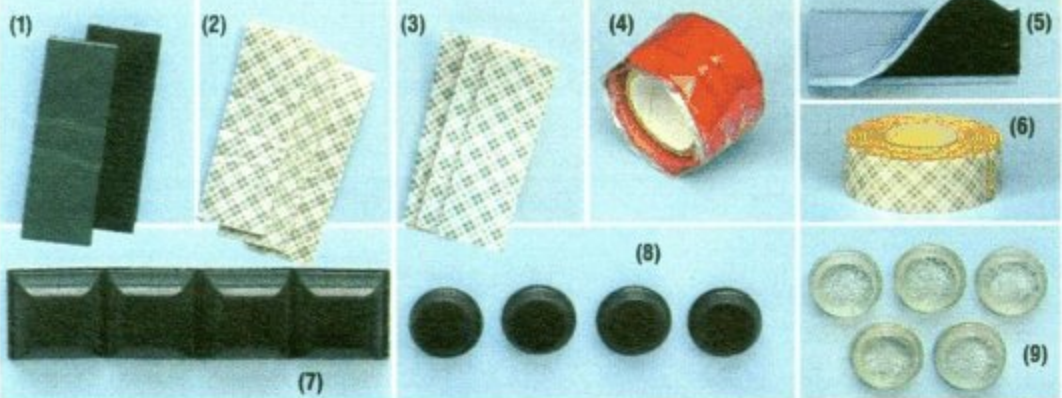

- (1) **SUPERLOCK Fasteners.** Five times the holding power of standard hook-and-loop fasteners. Four 1" x 3" strips. **64-2360**, **2.49**
- (2) **Double-Sided Tape.** Package of eight 1" x 3" strips. **64-2344** **1.99**
- (3) **SUPERMOUNT Foam Tape Strips.** Set of four 1" x 3" double-sided strips. Great for mounting items on wall. **64-2361** **1.99**
- (4) **Silicone Tape.** Easier-to-use substitute for heat-shrink tubing and tape. 1" x 3-ft. roll. **64-2336** **1.99**
- (5) **Hook-and-Loop Fasteners.** Handy way to keep items where you want them. Four pairs of 3" strips. **64-2345** **2.19**
- (6) **Two-Sided Foam Tape.** 3/8" x 40" roll. **64-2343** **1.89**
- (7) **Jumbo-Size Cushion Feet.** Square 3/4" stick-on cushions. **64-2342** **Pkg. of 8/1.49**
- (8) **Self-Stick Cushion Feet.** Add to equipment to protect furniture/shelf. **64-2346**, **Pkg. of 12/99¢**
- (9) **Clear Cushion Feet.** 1/2" diameter round plastic protectors. **64-2365** **Pkg of 12/1.19**



We Have a Wide Selection of Adhesives and Magnets

- (1) **NEW Super Glue Stick.** Pushbutton dispenser, no mess. Bonds on contact. **64-2327** **1.99**
- (2) **NEW One-Minute Epoxy.** Super strength without the wait. Automatic mixer. 1 oz. **64-2328** **3.69**
- (3) **All-Purpose Adhesive.** 1 3/4 oz. **64-2307** .. **1.69**
- (4) **High-Tech Bonding Gel.** Bonds almost anything. With 1/2-oz. accelerator. **64-2306** **5.99**
- (5) **Instant-Bonding Glue.** 0.11 oz. **64-2308** .. **1.69**
- (6) **Twin-Tube Epoxy.** No mixing. Meters out correct ratio of resin and hardener. 1 oz. **64-2313** .. **2.69**
- (7) **Silicone Rubber Sealant.** Moisture resistant. Remains flexible. Big 3-oz. tube. **64-2314** **2.99**
- (8) **Plastic Bonder.** 1 oz. **64-2305** **3.89**
- (9) **Horseshoe Magnet.** 7 1/2-lb. pull. Has mounting hole. 1 1/2 x 1 1/8 x 1/2", with keeper. **64-1887**, **7.99**
- (10) **Super-Strong Rare-Earth Magnet.** Incredible power, yet only 1/4" diameter. **64-1895**, **Pair 1.49**
- (11) **Magnetic Tape.** Holds tools to wall and more. Adhesive backed. 1/2" x 30". **64-1890** **99¢**
- (12) **High-Energy Ceramic Magnet.** 1 7/8 x 7/8 x 3/8". **64-1877** **89¢**

Ceramic Magnets		Each 23¢			
Fig.	Type	Cat. No.	11-24	25-99	100-Up
13	1 1/2" Round	64-1885	20¢	19¢	17¢
14	1" Rectang.	64-1875			
15	1/2" Button	64-1880			



Hardware in Transparent Handy-Paks, Only \$1.29 Each

Fig.	Description	Qty.	Cat. No.
1	Round-Head Machine Screws. 2-56	42	64-3010
	Machine Screws. 4-40	42	64-3011
	Machine Screws. 6-32	42	64-3012
2	Pan Head Sheet-Metal Screw Assortment	35	64-3016
3	Steel Machine Hex Nuts. 40 each: 2-56	40	64-3017
	Steel Machine Hex Nuts. 30 each: 4-40	30	64-3018
	Steel Machine Hex Nuts. 30 each: 6-32	30	64-3019
4	Flat Washers. 20 each of #2, #4, #6, #8, #10	100	64-3022
5	Grommets. 7 each: 1/4", 3/16", 3/8". 5 each: 7/16", 1/2"	31	64-3025
6	Solderless Ring Tongues	24	64-3030
7	Solderless Spade Tongues	24	64-3031
8	Solderless Insulated Ring Tongue Assortment	10	64-3032
9	Solderless Insulated Spade Tongues	10	64-3033
10	Solderless Spade Tongues. 12 each: (22-18), (16-14)	24	64-3034
	As Above, But Five Each	10	64-3035
11	Male Quick-Disconnects	8	64-3038
12	Female Quick-Disconnects	8	64-3039

Fig.	Description	Qty.	Cat. No.
13	Insulated Closed-End Connectors	10	64-3041
	5 each: (32-14), (16-10)		
14	Solderless Spades	10	64-3042
15	Solderless Flanged Spades	24	64-3043
16	Solderless Insulated Spades (22-14)	8	64-3044
17	Female Flag Quick-Disconnects	10	64-3046
18	Solderless Insulated M/F Q-Ds (22-14)	8	64-3049
19	Single Female to Dual Male Quick-Disconnects	6	64-3061
	3 Right Angle, 3 Offset		
20	Control Nuts	23	64-3020
	Metric Control Nuts	20	64-3063
21	Aluminum Spacers	24	64-3024
22	Wire Connectors	16	64-3026
23	Polypropylene Cable Clamps	18	64-3028
24	Butt Connectors. 10 ea. (22-18), (16-14)	20	64-3036
25	Insulated Butt Connectors	10	64-3037
26	Insulated Large Ring Tongues	6	64-3040
27	Bullet Connectors, Insulated	9	64-3047

Storage Box.
8 1/2 x 4 1/4 x 1 1/2".
64-552 **2.99**

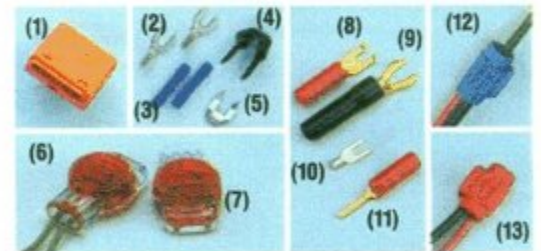

Parts for Wiring

Fig.	Description	Qty.	Cat. No.	Price
1	New! Push-Lock™ Wire Connectors	5	64-3056	1.39
2	Insulation-Piercing Phone Spade Lugs	24	64-3070	1.29
3	Phone Wiring Butt Connectors	24	64-3073	1.29
4	Standard Wire Staples	40	64-2875	.99
5	Miniature Wire Staples	50	64-2876	.99
6	Phone/Alarm Wire Splices	4	64-3080	1.69
7	Phone Wire UG Tap Connectors	4	64-3081	1.89

Terminals and Connectors

Fig.	Description	Qty.	Cat. No.	Price
8	Small Gold-Plated Terminals*	8	64-402	4.69
9	Large Gold-Plated Terminals*	8	64-401	5.19
10	Solderless Crimp Lugs	100	64-406	1.99
	Insulated Crimp Lugs	75	64-407	1.99
	Antenna Lead Terminals	12	64-408	1.29
11	Gold-Plated Pin Connectors*	4	64-403	3.29
12	Wire Tap-Ins (14-18 gauge)	10	64-3052	1.69
13	Low-Voltage Tap-Ins (18-22 gauge)	7	64-3053	1.69

*For use with our MEGACABLE™.



New! Talking Chess Computer Coaches You With "Human" Voice

Speaks 345 different phrases to teach and amuse you! Features 32 skill levels from beginner to intermediate, even a special tutorial level for new players. Vocabulary modes for teaching/coaching, demo and assisting visually handicapped players. Sensory board automatically records moves. Memory stores positions and unfinished games, allows take backs. Requires 4 "AAA" batteries or AC adapter. **60-2255 . . . 99.95**

Electronic fun & games that test your skills

We've got the very latest in electronic games for home or on-the-go! Try your luck against a casino dealer or match wits against a chess computer—if you dare!



New! Electronic Draw Poker

Just like Vegas! Flashes and plays music for winners. Shuffles 80 times between hands. One or two players. Folding stand. Requires 2 "AAA" batteries. **60-2453 . . . 29.95**

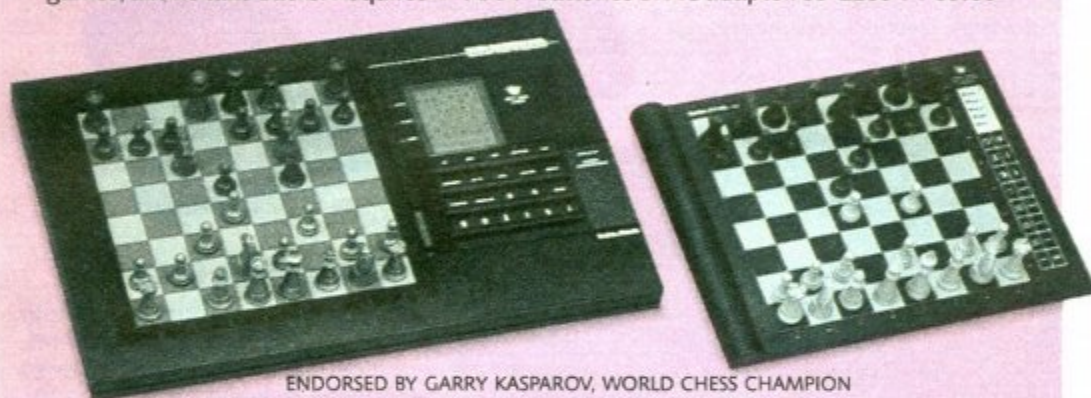

ENDORSED BY GARRY KASPAROV, WORLD CHESS CHAMPION

Chess Champion 2150L. Our best! Powerful 32K program is able to defeat 98% of all players. Shows time, depth of search, levels. Prevents illegal moves. LCD board display. Ideal for any chess fan, it provides skill levels from beginner to master. Requires 6 "C" batteries or AC adapter. **60-2254 . . . 159.95**

Super Sensory Chess 1680L. Features a fast-response coprocessor with built-in 8K program. Contains 16 different skill playing levels, including fun and puzzle levels. Take back and set up capabilities. Memory retains last game. Requires 4 "AA" batteries or AC adapter. **60-2253 . . . 69.95**



New! Pocket Blackjack 21

Casino action and thrills without the expense. Uses 52-card deck. Auto-scoring. Flashing "win" light. One or two players. **60-2454 . . . 29.95**



ENDORSED BY GARRY KASPAROV

Portable Sensory Chess Computer 1650L. Take it along! Has 16 skill levels, memory, folding case. Requires 3 "AA" batteries. **60-2252 . . . 49.95**

Pocket Chess 1100L. One or two players can play anywhere! Functions include en passant, pawn promotion and castling. "Suggest" button. Two skill levels. Sound on/off and LCD display intensity controls. Includes CR2032, CR2025 batteries. **60-2256 . . . 69.95**

LCD Golf Game

An 18-hole golf course you can hold in your hand and play anywhere. Musical sound effects add to the excitement. One or two players. Includes 2 RS357A batteries. **60-2239 . . . 14.95**



Stress Eliminator

Blast away at stress! Six sounds: zapper, rat-a-tat, laser shot, bombs away, quick-shot and blaster. Req. 2 "AA" batts. **60-2214 . . . 7.95**

Your complete store for video game accessories

Whether you're a kid—or just a kid at heart—you'll get more excitement from your electronic video games with name-brand joysticks, controllers and system enhancements.

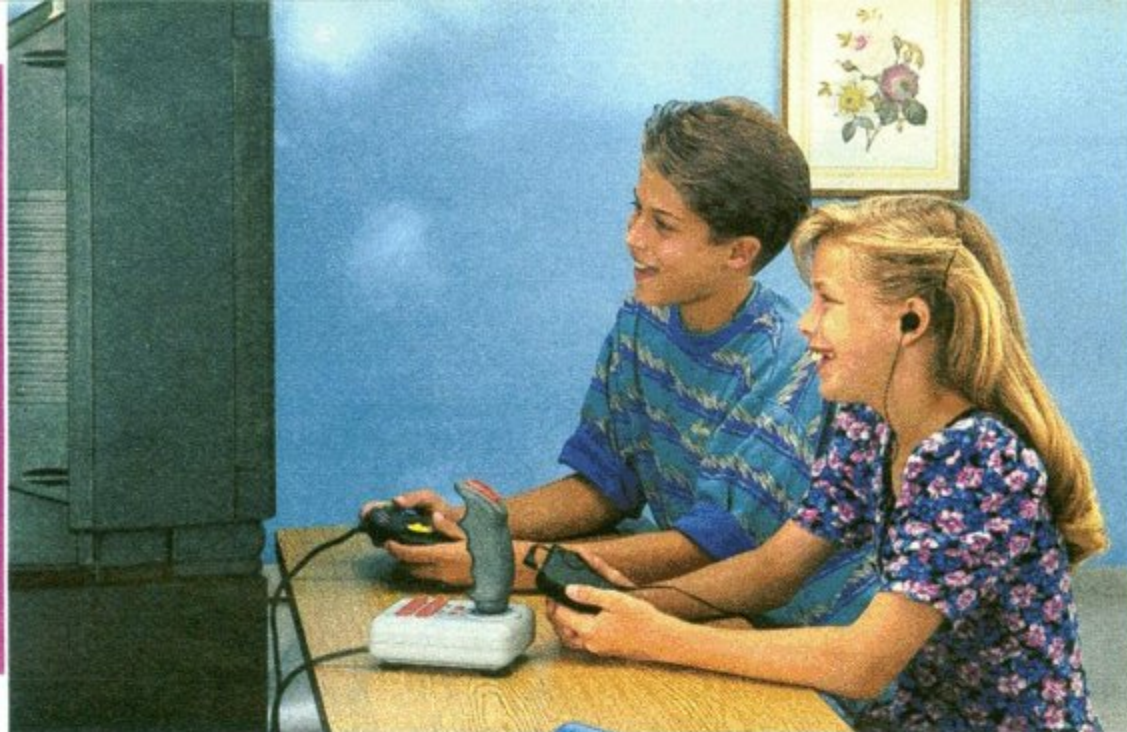

New! GameSounds™
Play Nintendo® games without disturbing others! Headphones work cordlessly up to 20 feet away. 270-1715 39.95

Competition Controller

Enhances the capability of your Nintendo joystick. Features 3-position A&B auto-fires, 2-directional inserts, extra-long cord. 270-1708 14.95
Accessories on this page for Nintendo not licensed, endorsed or approved by Nintendo of America Inc., and the words "Nintendo" and "Nintendo Entertainment System" are registered trademarks of Nintendo.



Competition Controller

For your SEGA Genesis. Contour grip, three independent rapid fires, 2-directional control inserts, stereo headphone jack and extra-long cord. 270-1709 19.95



New! Cleaning Kit for Nintendo

Makes your old Nintendo games play like new! Eliminates flashing, scrambled and blank screens by removing dust and dirt build-up in game systems and cartridges. 270-1716 9.95



New! Cleaning Kit for SEGA

Eliminates flashing, scrambled and blank screens by removing dust and dirt build-up in game systems and cartridges. Makes your old SEGA® games play like new. 270-1717 9.95

Competition-Performance Joysticks

- (1) **Jet-Fighter Style.** Accurate joystick action for many Atari, Sears, NEC and Commodore. 9-pin connector. 270-1701 10.95
- (2) **Super-Deluxe Competition Joystick.** For Nintendo. Features two "fire" buttons. The "auto-fire" function releases a steady stream of "bullets". 270-1704 17.95

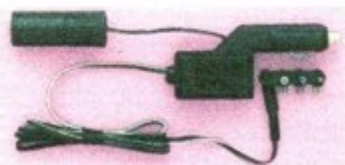

Car Power Adapters

- For Many Popular Video Games. 270-1504 19.95
- For Nintendo and Super Nintendo. 270-1505 15.95
- For Nintendo Game Boy. 270-1506 9.95



Carrying Case

Perfect for video games and gear! Also stores up to 10 audio or 8mm cassettes. With handy carry strap. 44-681 ... 9.95

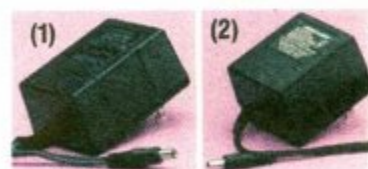

AC-to-AC Adapters

- (1) For Nintendo Games. 273-1611 15.95
- (2) For Game Boy. 273-1610 7.99



New! Repair Pads for Nintendo

Includes parts to rebuild two Nintendo controllers. Replace worn directional button, start/select switch, A&B buttons, directional response pad and A&B response pad. 270-1718 7.99

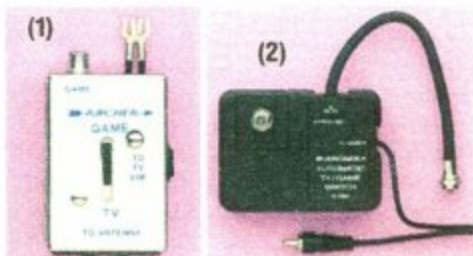

Video Game Selector Switches

- Allows you to switch easily between TV and video games without connecting and reconnecting cables.
- (1) 300-Ohm TV Switch. 15-1255 4.29
 - (2) Automatic TV/Game Switch. 15-1267 8.99
 - 300/75-Ohm Antenna Input Switch. 15-1269 4.29
 - 300/75-Ohm Signal Splitter/Switch. 15-1268 6.29

High-performance radio-controlled action vehicles are fun for all ages—come in and see our tremendous selection

We're America's leading retailer in RC vehicles. From rugged-terrain 4-wheelers to sleek, speedy racers, we offer you a fabulous selection in every price range.

All are designed for performance and durability. Different control frequencies allow you to compete. For example, choose a 27 MHz car to race with a 49 MHz car.



Black Phantom. Digital-proportional. 4WD. 17½" long. 27 MHz. Requires 10 "AA" batts., #23-230 Ni-Cd pack, #23-231 charger. 60-4103 119.95



Sagitta™. Twin motors. Digital-proportional. 15½" long. 27 MHz. Req. 10 "AA" batts., #23-230 Ni-Cd pack and #23-231 charger. 60-4102 99.95



Black Wolf. Precise digital-proportional steering. 15½" long. 27 MHz. Req. 10 "AA" batts., #23-230 Ni-Cd pack, #23-231 chgr. 60-4101 . . 79.95



Thunder Fox. Digital-proportional. 15½" long. 27 MHz. Requires 10 "AA" batteries, #23-230 Ni-Cd pack and #23-231 charger. 60-4099 69.95



4-Wheel Drive Big Panther. Two speeds. 14" long. 27 MHz. Charging jack. Requires 9V and 8 "AA" batteries. 60-4095 39.95



Turbo-Buggy Master. Two speeds, 4-wheel spring suspension. 14" long. 27 MHz. Charging jack. Requires 9V and 8 "AA" batteries. 60-4045 39.95



Red Blaster. High-traction knobby tires and spring suspension system. 10¼" long. 27 MHz. Requires 9V and 6 "AA" batteries. 60-4083 17.95



Off-Road Champ Aero Buggy. Knobby high-traction tires. 6¾" long. 49 MHz. Requires 9V and 4 "AA" batteries. 60-4089 9.95



Sonic Thunder Truck. Air-filled tires, 4-spring suspension. 14" long, over 8" high. 27 MHz. Requires 9V and 8 "AA" batteries. 60-4098, 54.95



4x4 Off-Roader. Two speeds and balloon tires. 12½" long. 49 MHz. Charging jack. Requires two 9V and 4 "C" batteries. 60-4046 47.95



Sonic Spider. Authentic sound effects and two speeds. 11" long. 27 MHz. Requires 9V and 8 "AA" batteries. 60-4094 39.95



Jumbo Van™. Turbo 4x4 with a back door that opens. 12½" long. 27 MHz. Charging jack. Requires 9V and 8 "AA" batteries. 60-4044 39.95



Surf Truck™. Cruise the beach! Removable camper shell. 11½" long. 27 MHz. Requires 9V and 6 "AA" batteries. 60-4043 19.95



Wild Cougar. Dual motors, gripper treads, 13" long. 27 MHz. Requires 9V batt., #23-229 Ni-Cd pack and #23-240 charger. 60-4097 49.95



Scorpion Tracks. Super-grip tank treads, two speeds. 13" long. 49 MHz. Charging jack. Requires 9V and 8 "AA" batteries. 60-4096 44.95



Blue Flash. Powerful twin motors and super-grip treads. 10" long. 27 MHz. Requires 9V and 4 "AA" batteries. 60-4091 14.95



Turbo 27. Turbo power for extra bursts of speed. "Mag"-style wheels. 12" long. 27 MHz. Requires 9V and 6 "C" batteries. 60-4074 24.95



Racer 27. Sleek design engineered for speed. 8" long. 27 MHz. Requires two 9V and 4 "AA" batteries. 60-4092 19.95



Police Car. Speeders beware! Has siren and flashing lights. 9" long. 27 MHz. Requires two 9V and 4 "AA" batteries. 60-4104 13.95



Sports Car Racer. European styling, high-traction tires. 10" long. 49 MHz. Requires 9V and 4 "AA" batteries. 60-4090 11.95

Science Fair® kits... a fun, educational and rewarding hobby

For all ages! The "hands-on" way to learn electronics. Premounted parts, springclip connectors, safe battery power. Kits for physics and architecture, too. With manuals.



Radio Kits With Earphones

- (1) **AM/VHF Project Kit.** Police, weather and local radio. Requires 9V battery. 28-163 12.95
- (2) **AM/FM Project Kit.** Local AM/FM radio. Requires 2 "AA" batteries. 28-175 12.95
- (3) **AM/Shortwave Project Kit.** Local/foreign stations. Requires 2 "AA" batteries. 28-176 12.95



280-Project Physics Lab Kit

Have fun learning about the laws of physics through experiments dealing with liquids, heat and sound. Projects include all necessary apparatus and instructions. Requires 2 "AA" batteries. 28-193 19.95



Junior Architect Lab

Design and plan your own model house. It's the creative way to learn drafting skills and interior decorating and design. Includes drawing board, ruler, compasses, cut-out sheets, building plans and brick mold. 28-187 17.95



ArcherKit® Multitester

For advanced hobbyists. 25 ranges, color-coded mirrored scale. 20,000 ohms/volt DC. With test leads. Requires soldering and "AA" battery. 28-4013 19.95



Available Oct. 30, 1992

The Best! New 300-in-1 Electronic Project Kit

Quickly teaches you about transistors, diodes, capacitors, oscillators, electronic circuits, and schematic symbols. You'll learn how to build a burglar alarm, telegraph, AM broadcast station, electronic game, battery checker and a whole lot more. It's hours of educational fun for the whole family. Complete lab-style manual takes you through each experiment. Requires 6 "AA" batteries. 28-270 59.95



130-in-1 Project Kit

Everything you need to discover electronics. Build your own radio, electronic organ, timer and more. Safe, simple coil-spring connection. Requires 6 "AA" batteries. 28-259 29.95



200-in-1 Project Kit

Out-front controls and meter. Integrated circuits with "OR," "AND," "NOR," and "NAND" gates help teach computer basics. Requires 6 "AA" batteries. 28-265 49.95



60-in-1 Project Lab Kit

Teaches the basics of electricity, physics, and electronics. Build a radio, metal detector, other projects. With earphone. Solderless. Requires 4 "AA" batteries. 28-261 19.95



30-in-1 Project Lab Kit

Teaches the basics of electronics with no soldering required. Build a radio, alarm, timer, and more. Includes earphone. Requires 2 "AA" batteries. 28-161 14.95



Crystal AM Radio Kit

Build your own radio that plays forever without tubes, transistors or batteries. Like the first radios, a crystal converts RF to audio. Tunes standard AM. With earphone. 28-177 6.95



New! 200-in-1 Kit

Build games—UFO Invasion, Quick Draw and Tug of War. Teaches basic electronics using transistors, LEDs and more. Requires 6 "AA" batteries. 28-262 49.95

Available Sept. 13, 1992

New! Metal Detector with Depth Meter— for Serious Hobbyists!

- Spots coins up to 8 inches deep and larger objects up to five feet deep
- Submergible—even works under water
- Three-tone audio object-identification

Micronta Discovery 2. Put maximum searching power right in your hands and locate treasures faster than you can dig them up! Features 10-inch magnum coil that operates in mineralized ground or on the beach with full power—can even be submerged in water up to the instrument cabinet. All-metal mode with retune button and pull-tab eliminator to reject aluminum and other "junk" items without missing valuables. Audio ID indicates targets before digging: Low tone for nickels; medium tone for tabs and most gold; high tone for other coins and silver. Weighs only 3 pounds. With arm brace, LED low-battery indicator, headphone jack. Requires two 9V batteries.

63-3004 169.95



An electronic adventure is waiting for you at Radio Shack

Choose one of five different Metal Detectors that fit your interests and budget—from our Treasure Finder for the kids to our new Professional Metal Detector for more serious treasure and souvenir hunters. Search for coins, jewelry, relics and other buried valuables. Turn a hobby into a rewarding adventure!

Space Patrol Walkie Talkies provide hours of neighborhood adventure for the kids as they talk with friends: "Meet me at the clubhouse, over" . . . "10-4, over." No license is required for these inexpensive, but rugged 2-way radios. Easy to use, fun for all ages. Great for biking, hiking, fishing trips, campouts.



Archer Space Patrol® Walkie Talkies

- (1) **Standard.** Buy two or more and talk to your friends or send secret messages in Morse code with the built-in code-key. Flexible antenna, on/off switch. Lock-on talk button. 5 1/16 x 4 1/4 x 2 5/8". Requires 9V battery. 60-4015 Each 9.95
- (2) **NEW! Micro-Size.** Less than 1" thin—so it fits right in your pocket and goes where you go. Ultrasensitive superregenerative receiver circuit. 1 1/2" speaker, push-to-talk button and flexible antenna. 5 5/16 x 1 3/4 x 7/8". Each requires 9V battery. 60-4021 PAIR 18.88
- (3) **NEW! Two-Way Headset Radio.** Adjustable "boom" microphone leaves your hands free. Great for camping or on-the-go. Operates indoors or outdoors. Rotary on/off volume control, headset-mounted antenna, belt-clip and push-to-talk button. 4 x 2 9/16 x 1 7/8". Each requires 9V battery. 60-4022 PAIR 19.95



Very Low Frequency Model Works Under Water

Strike it Rich! Treasure Finders

- (1) **Low-Cost Finder.** Spots metal buried up to 6"! Easy-to-use tuning controls. Adjustable handle. Requires 9V battery. 60-3003 14.95
- (2) **Discriminator.** Spots "junk" to avoid needless digging. Meter, speaker, headphone jack. Requires 6 "AA" batteries. 63-3002 59.95
- (3) **"Standard" Detector.** Faraday shield cuts false signals. Water-resistant coil. Ferrous/nonferrous control, meter, headphone jack. Requires 6 "AA" batteries. 63-3001 39.95
- (4) **Very-Low Frequency.** Works even in highly mineralized ground and shallow water. Sensitivity control, meter, speaker and headphone jack. Requires 3 9V batteries. 63-3003 89.95

**Add excitement to
your next party
with lights and music**



Illuma-Storm® Jr.

NEW! Amazing patterns of "lightning bolts" respond to music, voice and touch. Your guests will love it. Perfectly safe. 12" high. UL listed AC.
42-3034 39.95



Kaleidoscope

Responds to sound and forms beautiful patterns of dancing colors. Intensity control. 12 x 12 x 3 3/4". UL listed AC. Was \$79.95 in '92 Catalog.
42-3039 69.95



Strobe Light

Switch it on and vary its flash rate to see people or objects "freeze" or move in slow motion. Polished reflector. Walnut vinyl finish. 7 1/2 x 7 1/2 x 4 3/4". UL listed AC.
42-3009 ... 34.95



Rainbows of Light

Faceted enclosure casts an array of colors about the room, floor and ceiling. 7" high. Great for parties or attention-getting displays. UL listed AC.
42-3018 13.95



Revolving Light

Reflector revolves to cast red search beams on walls, furnishings and ceiling. 7" high. UL listed AC.
42-3040 31.95



"Chase Sequence" Lighting System

Terrific for festive occasions, holiday lighting and eye-catching store displays. Flexible 25-foot rope contains 105 bulbs that flash in a spectacular chase routine. Built-in controller lets you adjust sequence speed, and you can bend the rope to fit around windows or doorways. Tube opens for easy bulb replacement. UL listed AC.
42-3042 39.95



(1) New! The Miracle Piano Teaching System™

Miracle Song Collections. Each volume contains 40 songs with accompaniments in a variety of musical styles, arranged for novice and expert skill levels.

Volume 1. 25-1915 49.95 Volume 2. 25-1916 49.95



Electronic Keyboards for Musicians of All Ages and Stages

(1) NEW! The Miracle Piano Teaching System. Designed to work with a PC-compatible computer, the Miracle makes learning to play faster, easier and more enjoyable than ever before. Using Artificial Intelligence, it monitors your progress and custom designs a library of personal exercises. Entertaining video games teach notes, chords, sight reading, music theory and more. Plays up to 16 notes and eight instruments at once through its built-in 4" stereo speakers, included headphones or your stereo system. Has 128 instrument sounds, 49 full-size velocity-sensitive keys with split-keyboard effects, volume, sustain pedal, built-in metronome. MIDI compatible. 31 3/4" wide. UL listed AC adapter. (TSP) 25-1821 399.95

(2) NEW! Concertmate®-900. An orchestra at your fingertips! Incredible 465-sound tone-bank, 61 keys for a complete 5-octave range, 10-note polyphonic for full "2-hand" chords, 20 auto-rhythms, stereo speakers and 1/8" headphone jack. 36" wide. Requires 9V and 6 "D" batteries (or AC adapter, extra). (TSP) 42-4017 249.95

(3) Concertmate-670. With 100 sounds, 100 auto-rhythms and Concert Chord accompaniment. 49 full-size keys, 8-note chords. 4 3/4" speaker, 1/8" output jack. 34 3/8" wide. Requires 6 "AA" batteries or AC adapter. Was \$149.95 in '92 Catalog. (TSP) 42-4012 **New Low Price! 119.95**

(4) Concertmate-460. 100 sounds, 19 rhythms, 13 accompaniments, 5 drum pads. 32 keys, 4-note chords. 3 1/8" speaker. 24 1/8" wide. Requires 5 "AA" batteries or AC adapter. (TSP) 42-4015 ... 59.95

(5) Concertmate-370. 25 preset sounds, 19 rhythms, 13 accompaniments, 4 drum keys. 32 micro keys, 2-note chords. 2 1/2" speaker. 14 3/4" wide. Requires 4 "AA" batts. or AC adapter. 42-4014 39.95

(6) RapMaster Concertmate-800. Play melodies or rap on 32 keys. 25 preset tones, 30 rhythms, 3 effects pads, dual-sound "scratch" table, mike for adding vocals. 3-note chords. 3 1/8" speaker. 20 1/4" W. Requires 5 "AA" batts. or AC adapter. Was \$99.95 in '92 Catalog. (TSP) 42-4016 **New Low Price! 79.95**

(7) Keyboard Stand. Holds 75 lbs. 42-4050, 39.95

The latest in personal electronics for health and home



Amplified Listener. Hear sounds around you like never before! Two built-in mikes and dual channels boost sounds while maintaining a natural sense of direction. Great for listening to nature sounds. Volume and Hi-Boost controls. 4 x 2 1/4 x 7/8". Requires stereo headphones with 1/8" plug and 2 "AA" batteries. 33-1093 21.95

NEW! Zoom Binoculars. 6x to 12x. This single pair can handle subjects as different as sports events, bird watching and astronomy. Pouch case, hand strap. 63-792 .. 89.95

Enjoy Better Health and Better Living — Electronically

- (1) **NEW! Sleep Machine.** Choice of three soothing sounds to lull you to sleep—rain falling in a forest, the "clickety-clack" of a train's wheels, or ocean surf. One-hour timer allows sound to fade away gradually. Built-in 3" speaker, plus pillow speaker. 1/8" earphone jack. UL listed AC. 63-646 39.95
- (2) **Indoor Thermometer/Hygrometer.** Accurately measures temperature from -58° to 158° Fahrenheit and relative humidity from 25% to 95%. Requires 2 "AA" batteries. 63-844 29.95
- (3) **Home/Auto Air Purifier.** Electronic ionizer eliminates tobacco smoke, cooking and pet odors, pollen and fine dust. Dual powered—includes UL listed AC adapter and 12VDC lighter plug. 63-643 29.95
- (4) **Dual-Display Thermometer.** Shows both indoor and outdoor temperatures. Memorizes highs and lows—makes it easier to regulate heating/cooling system. Requires 2 "AA" batteries. 63-843 ... 29.95
- (5) **In/Outdoor Thermometer.** Switchable in/outdoor display. With RS357A battery. 63-842 14.95
- (6) **Battery-Powered Door Chime.** Add a doorbell for back or side door. No AC is required—install it anywhere. "Ding-dong" chime. With 6 1/2 feet of hookup wire. Requires 2 "AA" batteries. 63-870, 12.95
- (7) **NEW! Desktop In/Outdoor Thermometer.** Dual-readout displays indoor/outdoor temperature in Fahrenheit or Celsius. Includes deskstand, 357A battery and outside sensor with 10 feet of wire. 63-845, 21.95
- (8) **Wireless Door Chime/Remote Pager.** Mounts for use as a doorbell—no wiring required. Or, use as a pager—push the transmitter button to signal receiver. Requires 9V and 3 "AA" batteries. 63-871, 19.95



New! Electronic Wind Chimes

Add the grace and beauty of wind chimes to your yard, porch or patio. Or, hang inside your home near an open window and fill the room with cheerful sounds. On/off switch—stops automatically after one hour. Requires 4 "AA" batteries. 63-949 59.95

Micronta Helps With a Healthier Life

- (1) **LCD Blood Pressure Monitor.** One-hand operation. Accurate display of diastolic and systolic pressure and pulse rate. Vinyl case. Requires 9V battery. 63-663 49.95
- (2) **Biofeedback Stress Monitor.** Electronically detects internal body changes caused by tension—helps you control harmful stress. Requires 2 "AA" batteries. 63-664 13.95
- (3) **NEW! Deluxe Walk & Jog Mate™ Pedometer.** Walk or jog your way to physical fitness. Has 7-day memory for walk, jog and caloric measurements. Settings for hour, minute, weight, stride and ideal caloric burn. Measures to 99,999 steps and to 999.99 miles. With RS386 battery. 63-668 29.95
- (4) **Walk-and-Jog Mate Pedometer.** Distance meter accurately measures to 99,999 steps and to 999.99 miles. Large, easy to read LCD display. Belt clip included. With RS386A battery. 63-682 19.95
- (5) **24-Hour Pillbox/Timer.** Box holds your pills, and alarm alerts you when it's time to take them. Counts down from 23 hours and 59 minutes. With RS357A battery. 63-881, 14.95
- (6) **LCD Fever Thermometer.** Accurate readings (± 0.2°F) in one minute. Auto-shutoff. Sterilized covers (available in drug-stores) slip onto the tip. With RS357A battery. 63-655, 9.95



The time is right for the new style of Micronta®

The Watchword of Precision

- (1) **Colored Graphic Display/Multifunction.** Calendar, stopwatch, pacer. With RS2016H battery. **63-5031, 24.95**
- (2) **LCD VoxWatch®.** Synthesized voice announces time. Built-in stopwatch. With CR2025 battery. **63-5041, 39.95**
- (3) **NEW! Man's Analog Calendar Watch.** With rotating bezel. With RS399 battery. **63-5073 34.95**
- (4) **NEW! LCD Calculator Watch.** LCD shows time/date. 24-hour travel alarm. Features 4-function, 8-digit calculator. With RS389 battery. **63-5071 12.95**
- (5) **LCD Analog/Digital Display.** Stopwatch, calendar, alarm. Water resistant to 100 feet. With RS391 battery. **63-5068 17.95**
- (6) **Dual-Display Chronograph.** Graphic LCD shows date, day, time. Stopwatch stores 29 lap positions, measures split time. With CR2330 battery. **63-5069 19.95**
- (7) **Lady's Classic.** Quartz accuracy, leather band, second hand. With RS371 battery. **63-5070 19.95**
- (8) **NEW! Stylish Analog/Digital Alarm.** Calendar, 24-hour alarm, stopwatch. Water resistant to 100 feet. With SR927W battery. **63-5072 29.95**
- (9) **Analog.** LCD displays month/date. Water resistant to 150 feet. With RS399 battery. **63-5065 19.95**
- (10) **NEW! LCD Chronoalarm.** Displays month/day/time. Stopwatch. 24-hour alarm, hourly alarm, calendar. Water resistant to 100 feet. With RS392 battery. **63-5078, 14.95**
- (11) **Extra-Large LCD.** Calendar, 24-hour alarm. Water resistant to 100 feet. With RS392 battery. **63-5064, 9.95**
- (12) **NEW! VoxWatch.** Voice announces time hourly. Displays time/date. With CR2025 battery. **63-5042 . . 19.95**
- (13) **NEW! Chronoalarm Watch.** Water resistant to a depth of 300 feet! With CR2016H battery. **63-5074 . . 27.95**



High-Accuracy LCD Stopwatches

- (1) **9-Lap Memory.** Times to 23 hours/59 minutes/59 seconds and ⁹⁹/₁₀₀ second. With neck cord and CR2016 battery. **63-5012 24.95**
- (2) **Professional.** Times to 9 hours/59 minutes/59 seconds and ⁹⁹/₁₀₀ second. Neck cord and RS357A battery. **63-5010, 19.95**

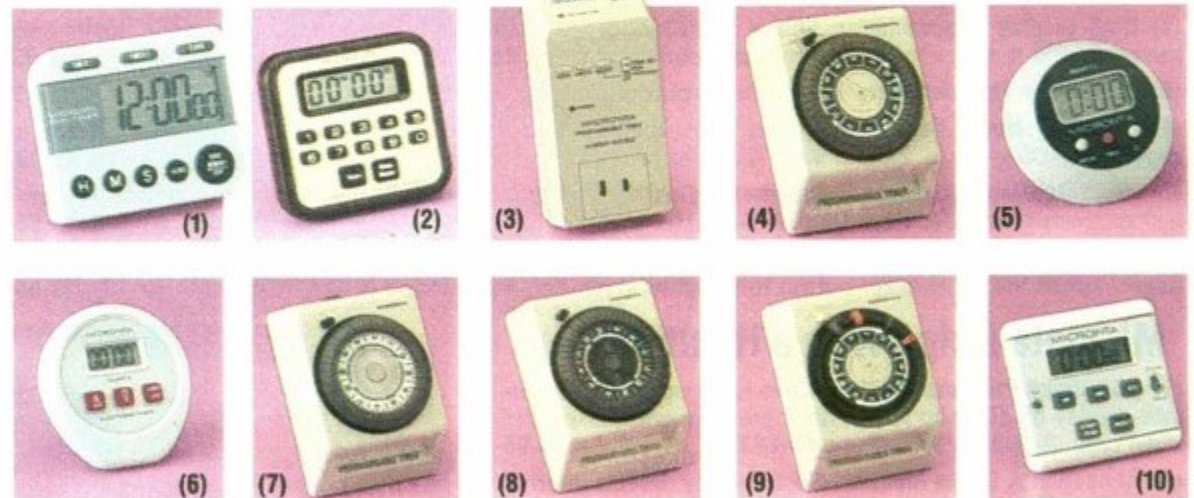

Clocks and Timers for Keeping Track of Every Situation

- (1) **LCD Clock with Dual Up/Down Timers.** Time up or down to 99:59:59, even two events at once. Timer alarm, memory. RS357A battery. **63-884 . . . 14.95**
- (2) **Pocket LCD Timer.** Fold-down stand for desk, plus pocket clip. Times to 99:59. With RS357A battery. **63-880 14.95**
- (3) **Eight-Event, 24-Hour LCD AC Timer.** Digital timer gives you four on/four off times daily. 15A. UL listed. Requires "AA" battery for memory backup. **63-891 22.95**
- (4) **Grounded Heavy-Duty AC Timer.** For air conditioners, heaters, computers and other high-current plug-in equipment. Two on/off settings per day, plus manual on/off. UL listed AC. **63-866 14.95**
- (5) **Stick-On LCD Clock/Timer/Calendar.** Times to 15 minutes. With RS357A battery. **63-840 3.99**
- (6) **Pocket/Magnet-Mount LCD Timer.** Times to 99:59. With RS357A battery. **63-879 10.95**
- (7) **Tabletop 24-Hour AC Timer.** For lamp or appliance, 12 on/off settings daily. Override. Rated 15A. UL listed. **63-865 14.95**
- (8) **Plug-In AC Timer.** Twelve hourly on/off cycles. Override. 15A. UL listed. **63-864 9.95**
- (9) **Mini Plug-In AC Timer.** Two on/off settings. Only 3⁷/₈ x 2³/₄ x 1⁷/₈". 15A. UL listed. **63-862 . . . 7.95**
- (10) **LCD Digital Clock Timer.** With clock, count-up and countdown timer modes. Memory recall repeats last countdown set. **63-883 14.95**

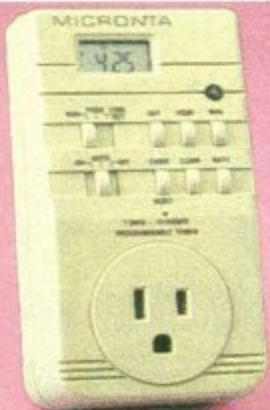

Deluxe Timer

7-Day, 14-Event LCD AC Timer. Up to seven on/seven off settings can apply daily or on specific day of the week. Rated 15A. UL listed. Includes memory backup battery. **63-892 27.95**

Electronic clocks and Alarms get you going

We've got the best selection in town! Whether you're a light sleeper or a heavy snoozer, Micronta helps you get your day started and on schedule.



Quartz-Accurate Alarm Clocks

- (1) **NEW!** Jumbo LED 1.8" Display. With hi/lo/off display and alarm. 63-767 24.95
- (2) **Big LED 0.9" Display.** With alarm volume control, p.m. indicator, snooze. 63-762 19.95
- (3) **NEW!** Neon Alarm Clock. Brilliant display! Snooze control and time/alarm button. 63-782 39.95
- (4) **Green LED 0.6" Display.** Built-in night light with hi/lo/off switch. Snooze control and p.m. indicator. 63-759 .. 19.95
- (5) **Large LED 1.4" Display.** With hi/lo dimmer, snooze control and p.m. indicator. 63-763 17.95
- (6) **Fluorescent 0.6" Display.** Auto-dimmer adjusts brightness to room light. Alarm volume control, snooze, 12/24-hour modes, p.m. indicator. 63-764 19.95
- (7) **LED 0.6" Display.** Our lowest-priced alarm. Snooze, p.m. indicator. 63-758 9.95
- (8) **Green LED 0.6" Display.** Snooze control and p.m. indicator. 63-757 13.95

CLOCKS ABOVE ARE UL LISTED AC AND HAVE BATTERY BACKUP

Specialty Clocks for Wall or Desk

- (1) **Giant 2 1/2" LED for Wall/Desk.** Switchable 12/24-hour modes. UL listed AC. Battery backup. 63-808 29.95
- (2) **Modern Wall Clock.** Stylish update of a classic design. 9" diameter. Requires "AA" battery. 63-810 12.95
- (3) **1.5" LCD Calendar/Clock.** Get time/date/day in one glance. Alarm, snooze. With RS357A battery. 63-761, 24.95
- (4) **Compact-Disc Table Clock.** Precision analog quartz movement. Requires "AA" batteries. 63-746 14.95
- (5) **NEW!** LCD 0.8" Display Desk Clock. Features snooze alarm. Requires "AA" battery. 63-744 11.95
- (6) **NEW!** World Time LCD 1.8" Display Desk Clock. LCD with world map. Battery included. 63-712 39.95
- (7) **NEW!** Quartz Clock 3-Level Alarm. Snooze alarm gets louder! Battery included. 63-713 24.95

Battery-Powered Mini Clocks

- (1) **0.8" LCD World Time.** Know the time in 20 major cities! Includes RS76 battery. 63-710 19.95
- (2) **NEW!** 0.3" LCD Vibrating Alarm Clock. Silent, tactile vibrating alarm action. Requires "AAA" battery. 63-711, 17.95
- (3) **Mini Analog Travel Alarm.** Luminous hands, 24-hour alarm, carry pouch. 2 1/4 x 2 1/4 x 1 1/8". Requires "AA" battery. 63-716 11.95
- (4) **LCD Travel Alarm With Extra-Large 0.7" Numerals.** Snooze, 24-hour alarm. 1 1/2 x 4 7/8 x 3/4". Requires 3 "AA" batteries. 63-709 13.95
- (5) **0.4" Display LCD Anywhere® Clock.** Stick on almost anything! 1 1/4 x 3 1/4 x 5/8". RS357A battery. 63-836 10.95
- (6) **0.5" LCD Micro Travel Alarm.** Backlight display, 24-hour alarm. 1 3/4 x 3 x 1/4". With RS357A battery. 63-706, 12.95
- (7) **Deluxe 0.7" LCD Travel Alarm.** Snooze. Folds in case to 1/2" high. 4 x 2 3/8". With LR43 battery. 63-708 17.95
- (8) **0.25" Display VoxClock 2.** Announces time hourly, or at tap of a button. Requires 2 "AA" batteries. 63-904, 34.95
- (9) **NEW!** 0.3" LCD Vox Alarm Clock with Key Chain. Talking alarm! Includes 3 RS357A batteries. 63-907 12.95
- (10) **0.9" LED Display VoxClock.** Dual alarm. Time given during alarm. UL listed AC (or 7 "AA" batteries, extra). 63-906, 49.95
- (11) **NEW!** 0.5" LCD Desktop Vox. Announces time hourly or by tapping a button. 63-908 21.95
- (12) **0.3" Display VoxClock Travel Alarm.** LCD display, built-in voice. With CR2030 batteries. 63-905 29.95

Battery Backup/Battery Sentinel®



Our AC-powered clocks have battery backups which keeps clocks running up to eight hours and operates alarm. Sentinel LED warns when battery is low.

BATTERY BACKUP IN AC-POWERED CLOCKS, EXCEPT 63-906, REQUIRES 9V BATTERY (EXTRA)

Find the answers with speed and ease that seem like magic!



New! Talking Dictionary

Franklin Language Master™ LM-4000. Clearly pronounces 83,000 words out loud! Over 274,000 definitions, 496,000 synonyms. Spelling correction. Requires 4 "AA" batteries. **63-700, 149.95**

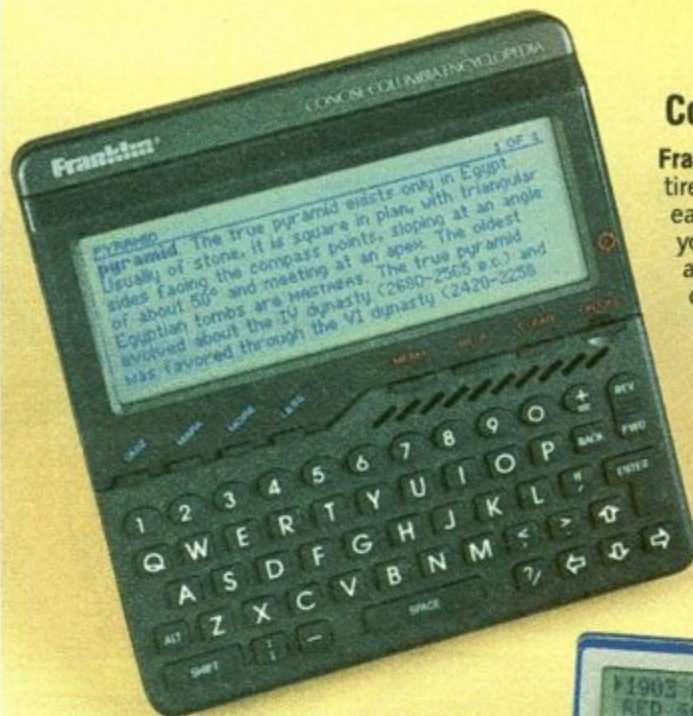

New! Concise Columbia Encyclopedia™

Franklin EC-7000. Contains the entire text of the second edition in easy-to-use electronic form. Lets you search through thousands of articles at computer speeds to locate references in seconds! Advanced digital cross referencing and phonetic spelling correction, more. Requires 4 "AAA" batteries. **63-696 199.95**

New! Baseball Encyclopedia

Franklin HR-61. Instant access to over a million big league stats! 620,000 batting statistics; 270,000 pitching stats; team batting records; Cy Young winners; MVPs; more! Biographical info on every player in AL and NL history—over 100 years—with individual records. With 2 "CR2032" batteries **63-699 99.95**



Foreign Language Translators

- (1) **NEW!** Franklin Spanish Master/Maestro Ingles™. Bilingual, English to Spanish or Spanish to English. 250,000 translations with gender forms, verb conjugations. Memory stores 700 personal words. Requires 4 "AAA" batteries. **63-701 ... 99.95**
- (2) **NEW!** Micronta® Two-Way Spanish/English Translator. From English to Spanish or Spanish to English. 12,000 words and 200 phrases. With 2 CR2025 batteries. **63-697 29.95**
- (3) Micronta Five-Language 4000-Word Translator. English, Italian, French, Spanish, German. With 2 CR2032 batteries. Was \$49.95 in 1992 Catalog. **63-683 New Low Price! 39.95**
- (4) **NEW!** Micronta Five-Language Word/Phrase Translator. Translates English, German, French, Italian, Spanish. 10,500 words, 480 phrases. With 2 CR2036 batteries. **63-698, 49.95**

Puzzle Solver



NEW! Franklin CW-40. Solve crossword puzzles fast! More than 250,000 words. Includes painters, authors, sports teams, geographic names, celebrities and much more. With CR2032 battery. **63-694 39.95**



The Holy Bible in Two Editions

Franklin® King James Bible KJ-21. Contains the entire text of both the Old and New Testaments in easy-to-use electronic form. Turn it on and read it just as you would a printed Bible. Or use the "search" function to find selected passages at computer speed—type in a key word or phrase and, instantly, the screen displays the verse. "Bookmarks" help you return to favorite passages. With helpful built-in index and thesaurus. Requires 4 "AA" batteries. (TSP) **63-680 199.95**
New International Version NIV-20. Same as KJ-21 above in the New International edition. (TSP) **63-684 199.95**

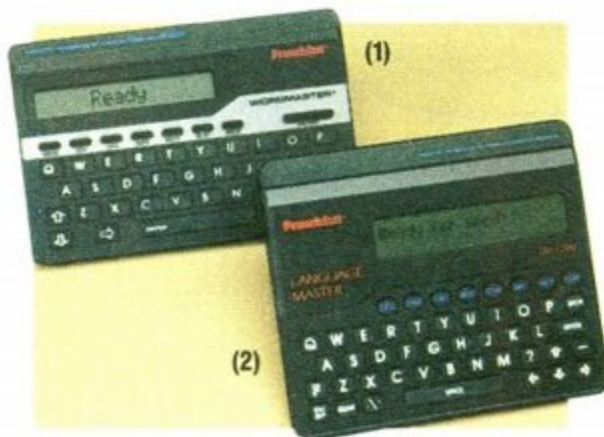

Thesaurus and Dictionary

- (1) **Franklin Wordmaster™ Thesaurus WM-1055.** Not a bit like digging through a printed thesaurus—the computer does all the hard work! Has spelling correction, 77,000 meaning cores to assist you in choosing the "right" word, and 487,000 synonyms for 40,000 entry words. Requires 4 "AAA" batteries. **63-692 ... 49.95**
- (2) **Franklin Language Master Dictionary and Thesaurus LM-2200.** Shares all the features of the WM-1055 above but with 274,000 dictionary definitions added. Requires 4 "AAA" batteries. (TSP) **63-693 79.95**



Phonetic Spelling Checkers

- (1) **Franklin Spelling Ace™ SA-95.** Enter a word the way it sounds, get the correct spelling instantly! 80,000 words. With CR2032 battery. **63-691 29.95**
- (2) **Franklin Spelling Ace SA-98.** Advanced spell checker. Correction for 80,000 words. With crossword puzzle solver. Requires 4 "AAA" batteries. Was \$34.95 in 1992 Catalog. **63-677 New Low Price! 29.95**
- (3) **Micronta Spell Checker.** Convenient pocket size. 88,000 words. With 2 CR2032 batteries. Was \$29.95 in 1992 Catalog. **63-674 New Low Price! 27.95**

Professional Labeling System

NEW! Create attractive peel-and-stick labels and lettering—it's easy and fun! Just type on the keyboard, then touch a button to print your label. 5 type sizes, 4 styles. LCD display lets you edit and correct errors before printing. Prints horizontally or vertically. Complete with black-type-on-white-tape cartridge. Requires 5 "C" batteries or AC adapter. (TSP)

63-647 149.95

Black-Type/White-Tape Cart. 63-648, Pkg. of 2/24.95
 Black-Type/Clear-Tape Cart. 63-649 .. Pkg. of 2/24.95
 Anelia PS Font Cart. (CMC) 63-631 24.95

Available through our Consumer Mail Center

Tape Cartridge	Cat. No.	Each
Black-Type/Yellow-Tape	63-621	14.95
Black-Type/Green-Tape	63-622	14.95
Black-Type/Blue-Tape	63-623	14.95



Tape Cartridge	Cat. No.	Each
Black-Type/Red-Tape	63-624	14.95
Gold-Type/Black-Tape	63-625	16.95
Red-Type/White-Tape	63-626	14.95
Blue-Type/White-Tape	63-627	14.95
Red-Type/Clear-Tape	63-628	14.95
Blue-Type/Clear-Tape	63-629	14.95
Gold-Type/Clear-Tape	63-630	16.95

Shop at Radio Shack for the very latest in electronics for your home and business

We are and have been America's electronics specialist for generations, introducing innovations in technology to homes, offices and schools across the country since 1921. As America's Technology StoreSM, we continue to create new standards of excellence in quality, service and customer satisfaction. These standards are the foundation of our business and proof that Radio Shack offers the best value in consumer electronics. Nobody Compares.

New! Programmable Scrolling LED Electronic Signboard

Ideal for retail advertisements, trade-show displays, public announcements—or just for fun! Scrolls messages in "ticker-tape" fashion. Stores up to four messages, each up to 600 characters long. The letters are over 1" high. Repeats a single message or any sequence of messages. Easy message editing on the built-in typewriter-style keypad. Alarm-signal jack for connecting the signboard to your security system. If alarm is triggered, signboard displays a special preprogrammed message to passing police or security personnel. With UL listed AC adapter. (TSP) 63-950 179.95



Desktop/Portable Copier That's Complete and Ready to Use

- Everything you need to get started—instantly!
- Features automatic multiple-sheet feeding
- Prints up to six copies per minute for only pennies per copy

Tandy® PPC 750. Just add plain paper and start turning out high-quality copies. Its slim design (47/8x147/16x153/4"), fold-away paper tray and light carrying weight (less than 25 pounds) make it ideal for desktop or travel. Comes with disposable black toner cartridge and drum. UL listed AC. (TSP) 63-686 599.95

Replacement Black Toner Cartridge. 63-688 99.95
 Blue Toner Cartridge. (CMC). 63-689 129.95
 Red Toner Cartridge. (CMC). 63-690 129.95
 Replacement Drum. (CMC). 63-687 199.95



Carry handle for easy portability



Folding paper trays recess into sides



Cordless Pencil Sharpeners And Halogen Table Lamp

- (1) Easy-to-use and safe—ideal for children. With spare blades. Requires 4 "C" batteries. 61-2795, 3.99
- (2) No cords to tangle. Performs like AC-powered sharpeners. Requires 4 "AA" batteries. 61-2590, 10.95
- (3) Height and angle adjustable—puts light where you want it. Hi/lo light levels. UL listed AC. 61-2552, 29.95

TANDYFAX saves you time, effort and delivery charges!

Send vital information anywhere in the world just for the price of a telephone call! It's easy—just connect a TANDYFAX to a touch tone or rotary phone line, and you're ready to send and receive crisp, legible copies of important letters, contracts, spreadsheets and other data—even line-art graphics and photos. And, TANDYFAX® machines double as convenient personal copiers.

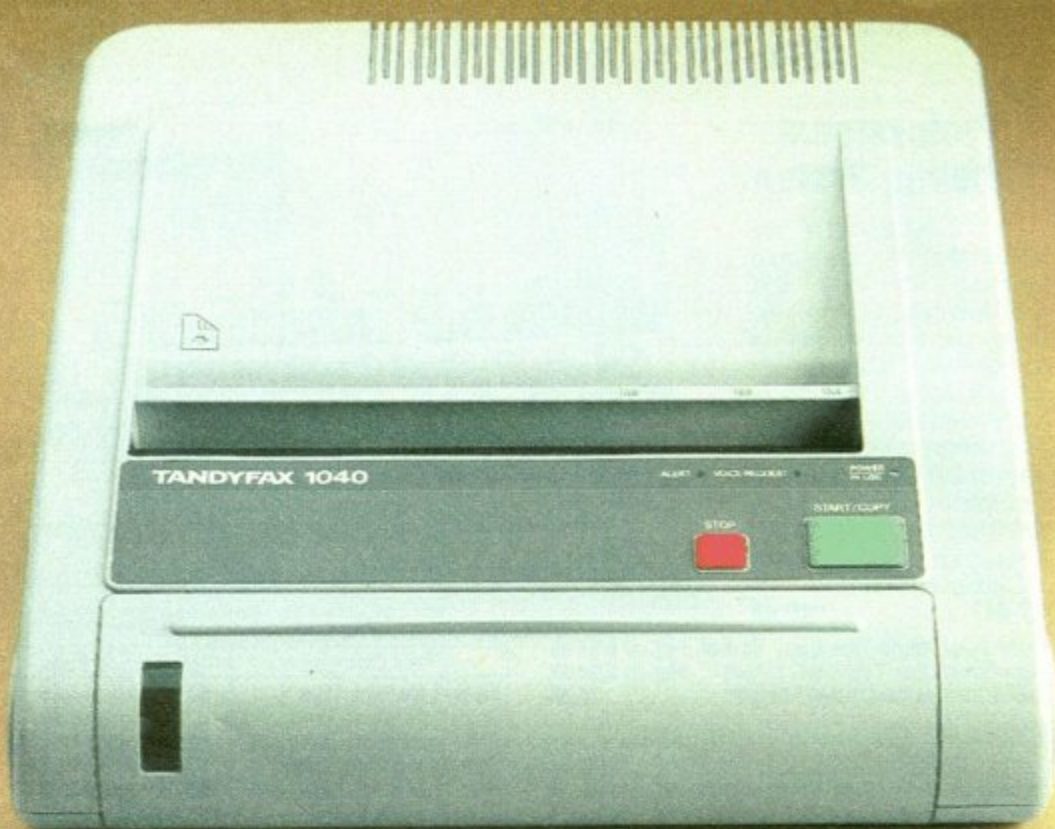

NEW! TANDYFAX® 1040. Don't let the low cost mislead you—this compact facsimile machine is packed with features. Built-in fax/answering machine switch. Receivers can readily identify your faxes because they're automatically sent with your phone number and company name. Automatically receives a fax call but beeps to alert you when a voice call comes through. Report printouts are in any of five languages—English, French, German, Italian or Spanish. Changing machine settings is a snap. Just select the appropriate Optical Programming Sheets (included) and feed them through—that's all there is to it. Other features include resolution adjustment to ensure the best possible copies, and 16-level halftone for sending photographs. And the TANDYFAX 1040 even doubles as a personal copier. (TSP) 43-1201 319.95



Untie Your Phone Lines With These Automatic Fax Switches

(1) **NEW! DUOFONE® AFX-200.** Enjoy the convenience of a dedicated fax line without the cost! Has voice priority and automatic modem/fax sharing. The AFX-200 lets you use "Distinctive Ringing" service (available from many phone companies) to have two phone numbers for one phone line. Calls coming in on one number are automatically routed to your fax machine, calls coming in on the other number ring through to be answered by you or your answering machine. Easy installation—just plug it in. Other devices like phones, modems, dictation machines, and answering machines can be connected to the FAX port instead of a fax. (TSP) 43-1243 119.95
Not compatible with some multiline phone systems.

(2) **DUOFONE AFX-150.** Automatically switches an incoming call to your fax machine after you answer if CNG (beeping) tones are detected. Otherwise, the call is treated like any phone call—you talk without any interruption or your answering machine takes a message. (TSP) 43-1240 89.95



TANDYFAX 1020. Simply connect this personal facsimile machine to a telephone line, and you're ready to send or receive documents in just seconds. Features include a built-in phone with 20-number memory, number redial, resolution adjustment, report printout for your records, polling function, white space compression for reducing transmission time, and 16-level halftone for sending photographs. (TSP) 43-1207 499.95

The Best in Thermal Fax Paper

This paper yields high-visibility contrast and will not interfere with photocopying. It delivers crisp, clear black images, not "fuzzy" gray which you get with some brands. The long-lasting thermal image won't fade like it can with inferior fax papers.

- Yellow.** 8½ x 98' roll. 43-1261 6.49
- White.** 8½ x 98' roll. 43-1260 5.49
- White.** Big 8½ x 164' roll. 43-1265 6.79





**12-Digit Fluorescent
With 2-Color Printing**

Radio Shack EC-3021. "Easy-access" keyboard for effortless operation—an unerring choice for anyone using a calculator throughout the working day. Speedy printing in red and black. Item-count printing, auto 3-digit commas, "00" key, mark up/down, percent keys. UL listed AC. Was \$69.95 in 1992 Catalog. (TSP) 65-971 **New Low Price! 59.95**

**10-Digit Fluorescent
Desktop Calculator**

Radio Shack EC-3022. This is a rugged workhorse you can count on! Sturdy "10-key" calculator features last-digit correction, auto-constant, "00" key, delta, mark up/down, percentage, paper feed and sign-change keys, 4-key memory. UL listed AC. 65-972 **49.95**



**Thanks, America!
You've made us #1 in
calculators...for years**

Radio Shack is America's #1 retailer of calculators, and it's easy to see why. You're sure to find the one you're looking for in our wide array of models. We have everything from basic handhelds to powerful desktop data organizers, and each is on display and ready to try out. Nobody can match our great selection. And with nearly 7000 stores nationwide, we're close by.



NEW! Radio Shack EC-3025. Great idea! Full-sized keyboard and printing in a cordless portable. Jumbo-sized digits. Functions for mark-up, "00," item-count print. Oversize "+" . . . **65-958, 39.95**

Plain and Thermal Printing Paper for Business Calculators

Low-lint, register bond paper gives you clear, crisp printing and keeps your printer mechanism clean. For Radio Shack printing calculators, as well as other brands.

Plain Paper for Radio Shack models

Size	Fits	Cat. No.	3-Pack
2 1/4"	65-664/669/952/954 957/958/965/966/967 968/969/970/971/972	65-710	2.49

Plain Paper for Radio Shack models

Size	Fits	Cat. No.	3-Pack
1 1/2"	65-666	65-712	1.59
1 1/2"	65-951/953/955	65-713	2.49
2 1/4"	65-954/956	65-715	2.79

Thermal Paper for Early Models. 2 1/2" size fits 65-643/644/645/646. 65-706 . . . **3-Pack, 3.69**



Radio Shack EC-3018. Portable printing desktop with 10-digit fluorescent display, item-count printing, "00," double-size "+" . . . Requires 4 "AA" batteries or AC adapter. 65-968 **49.95**

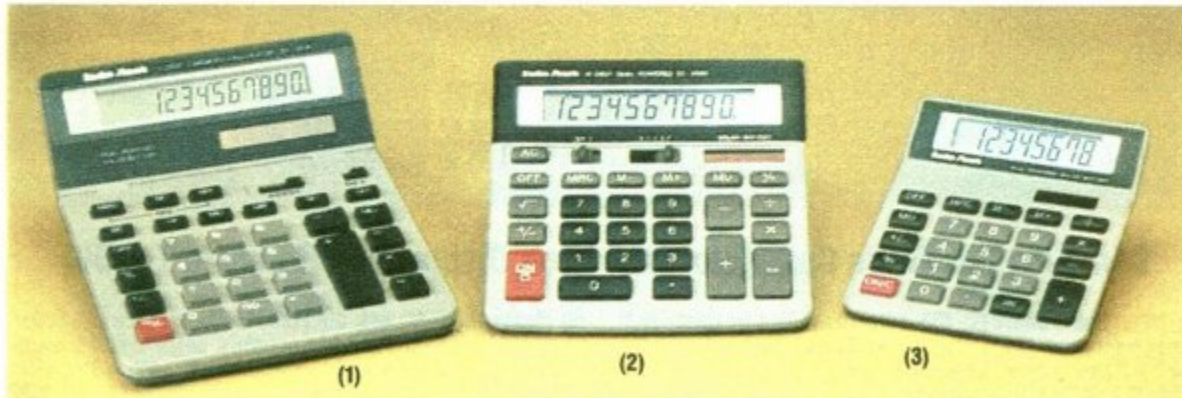

Dual-Powered 10-Key Calculators for People Who Don't Need Printouts

(1) Radio Shack EC-2018. Two memories come in handy for balancing a checkbook or anytime you need to run two totals simultaneously. Exclusive Adjusta-tilt™ display lets you set the angle of the big, 12-digit LCD for your viewing comfort. Auto-switches from solar to battery power in dim light. Thinline design slips into a briefcase with room to spare—only 1/2 x 5 3/8 x 7 3/8". With RS357A battery. Was \$29.95 in 1992 Catalog. 65-580 **New Low Price! 24.95**

(2) NEW! Radio Shack EC-2020. Compact—yet has full-size keys and big, easy-to-read digits. Tilted display for viewing comfort. Double-size "+," "-", and "=". Three-key memory and markup key. Switches from solar to battery power in dim light. With RS357A battery. 65-584 **19.95**

(3) NEW! Radio Shack EC-2019. Big, easy-to-read LCD display. Oversize "+" key. Markup, percent and sign-change keys. Three-key memory. Solar/battery with RS389 battery. 65-583 **10.95**



Paper feeds from internal compartment or fold-out roll holder

NEW! Radio Shack EC-3024. Desk/handheld printing calculator. Features "10-key" design, takes standard 2 1/4"-wide paper. Requires 4 "AA" batteries or AC adapter. 65-957 . . . **29.95**

ALL CALCULATORS ARE COVERED BY OUR ONE-YEAR LIMITED WARRANTY—SEE STORE FOR DETAILS

We have more than 50 calculators to choose from—why shop anywhere else?

New! Jumbo LCD & Clock/Calendar

Radio Shack EC-448. Handy 3-in-1 combination gives you the time and date in a fun-to-use calculator with a giant-digit display. Delta key can double as mark-up. Has three-key memory, percent, square root and sign-change keys. Dual powered to extend battery life. Auto power-off. $4\frac{9}{16} \times 2\frac{11}{16} \times \frac{1}{4}$ ". With billfold case and LR1130 battery. 65-892 .. 11.95

New! Talking Calculators—They Actually "Tell" You the Answers

- (1) **Radio Shack Desktop EC-208.** A clear, pleasant voice confirms every keystroke you make, then announces calculation results when you push the "=" key. Big-digit display and jumbo keys for easy operation. Voice-on/off, volume control. Clock with alarm. $5\frac{1}{8} \times 6\frac{7}{8} \times \frac{9}{16}$ ". Requires 2 "AAA" batteries. 65-554 24.95
- (2) **Radio Shack Nine-Language EC-210.** Full-function calculator speaks English, German, French, Italian, Spanish, Arabic, Mandarin Chinese, Cantonese and Russian. Built-in clock with alarm. $3 \times 5 \times \frac{5}{8}$ ". Requires 3 "AAA" batteries. 65-556 29.95
- (3) **Radio Shack Handheld EC-209.** Compact size slips easily into jacket pocket or purse. Four-key memory and percent key. Voice-on/off, volume control. Clock with alarm. $3\frac{1}{4} \times 5\frac{1}{2} \times \frac{5}{8}$ ". Requires 2 "AAA" batteries. 65-555 19.95

Lady's "Compact" Calculator

Radio Shack EC-422. Nice to give or get! A colorful calculator in an elegant lady's compact case that folds to just $2\frac{3}{4} \times 2\frac{5}{8} \times \frac{1}{2}$ ". Has 3-key memory, auto-constant, percent and sign-change keys. Solar powered. 65-912, 9.95

Uniquely Styled in Decorator Colors

Radio Shack EC-428. Whoever said calculators have to look alike? Big, easy-to-read digits and comfortably spaced keys make it a pleasure to use. Three-key memory. Dual powered. With case, RS389A battery. 65-914 9.95

Credit Card Calculator

Radio Shack Micro-Thin® EC-413. Just slip it into wallet or purse with your credit cards—only $2\frac{1}{8} \times 3\frac{3}{8} \times \frac{1}{8}$ " thin. Square-root and percent keys, 3-key memory. Auto-constant. Solar powered. With case. 65-910 7.95

Electronic Check Balancing

Radio Shack EC-430. Features balance, charge, payment, deposit and check keys. Case holds register, checks, pen. Dual powered. $2\frac{3}{4} \times 6\frac{1}{8} \times \frac{5}{8}$ ". With RS389A battery. Was \$15.95 in 1992 Catalog. 65-570 14.95



Come in! Our Entire Calculator Line is on Display and Ready to Try Out

- (1) **NEW! Radio Shack EC-433.** Extra-large keys for faster and easier operation. Sign-change key, 3-key memory, double-size "+" and "C/CE" keys. Dual powered. $2\frac{7}{8} \times 4\frac{7}{8} \times \frac{1}{2}$ " (folded). With RS389A battery. 65-916 12.95
- (2) **Radio Shack EC-416.** Jumbo LCD display and keys. Convenient, horizontal folding style. Square-root and percent keys, auto-constant and auto-shutoff. $2\frac{3}{4} \times 4\frac{1}{2} \times \frac{5}{8}$ " (folded). With RS389A battery. 65-561 9.95
- (3) **Radio Shack EC-431.** Set Adjusta-tilt™ display angle for your personal viewing comfort! Features 3-key memory, nonskid keys. Dual powered. $4\frac{3}{8} \times 2\frac{1}{2} \times \frac{1}{4}$ ". With case and RS389A battery. 65-565 9.99
- (4) **Radio Shack EC-447.** Adjusta-tilt display with giant digits provides you with the ultimate in viewing comfort. Four-key memory. Dual powered. $5\frac{3}{8} \times 3 \times \frac{3}{8}$ ". With case and RS389A battery. Was \$11.95 in 1992 Catalog. 65-891 **New Low Price! 9.95**

- (5) **Radio Shack EC-445.** GPM key for the rapid computation of desired markup. Four-key memory, percent and square-root keys. Dual powered, auto-shutoff. $4\frac{1}{2} \times 3\frac{1}{2} \times \frac{1}{4}$ ". With billfold case and RS389A battery. 65-889 8.95
- (6) **Radio Shack EC-414.** Display is tilted for convenient desktop viewing. Percent, square-root and sign-change keys. Three-key memory. Dual powered, auto-shutoff. $4\frac{1}{2} \times 2\frac{3}{4} \times \frac{3}{4}$ ". With RS389A battery. 65-560 7.95
- (7) **Radio Shack Mity-Thin® EC-427.** Compact size with big, easy-to-read digits. Has 3-key memory, square-root and percent keys. Dual powered, auto-shutoff. Only $3\frac{3}{8} \times 2\frac{1}{8} \times \frac{1}{4}$ " thin. With billfold case, RS389A battery. 65-895 6.95
- (8) **NEW! Radio Shack EC-432.** Feature-packed calculator at a terrific low price! Pressing any function key brings that symbol (+, ×, ÷) to the display to remind you of the current mode. Big, easy-to-read digits, 3-key memory. Solar powered. $4\frac{1}{4} \times 2\frac{5}{8} \times \frac{1}{4}$ ". With case. 65-596 5.95



Our scientific and financial calculators solve those difficult problems easy as Pi

New! Graphic Calculators—the Next Generation of Scientifics

- (1) **Radio Shack Programmable EC-4034.** Helps you visualize complex relationships. Create polar-coordinate, inequality and integration graphs. 300 functions. Up to 4164 program steps and up to 548 memories. $6\frac{3}{4} \times 3\frac{1}{4} \times \frac{5}{8}$ " . With hard case, 3 CR2032 batteries. (TSP) 65-804 **99.95**
- (2) **Radio Shack Programmable EC-4033.** Plots the same graphs as the EC-4034 above but with a smaller graph. 107 functions. Up to 400 programmable steps or up to 76 memories. $5\frac{5}{8} \times 2\frac{7}{8} \times \frac{3}{8}$ " . With hard case, 2 CR2032 batteries. 65-803 **49.95**

New! Scientific Programmable

Radio Shack EC-4027. What a value! Features 202 functions, including 164 scientific. Stores up to 40 steps in one or two programs and features seven memories, 15 levels of parentheses and eight pending operations. Guidance Display shows math symbols during operation. Auto power-off. $5\frac{5}{8} \times 3 \times \frac{3}{8}$ " . With 2 RS357A batteries. 65-999 **24.95**

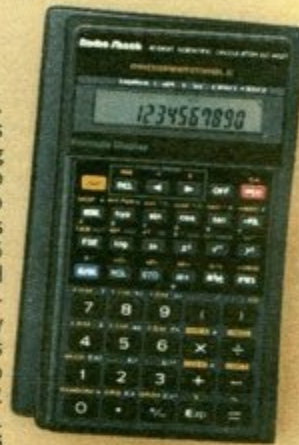

We Have Scientific Calculators to Fit Any Budget or Application

- (1) **Radio Shack 1103-Step Programmable EC-4026.** One of the most powerful calculating tools available. Two-line display lets you enter and execute formulas exactly as they are written, even integral and fraction calculations. Features 179 scientific functions and engineering symbol calculations. $5\frac{5}{8} \times 2\frac{7}{8} \times \frac{3}{8}$ " . With CR2025 battery. 65-993 **47.95**
- (2) **Radio Shack Electrical Engineering EC-4035.** Accepts input and displays output using popular electronic/electrical engineering symbols—1000Ω × .5A=500V. Alphanumeric display with contrast control. Functions for trig, statistics, fractions and complex numbers. Engineering keys, auto-shutoff. 10-digit mantissa, 2-digit exponent. $5\frac{1}{8} \times 2\frac{7}{8} \times \frac{3}{8}$ " . With case and 2 CR2032 batteries. 65-983 **39.95**
- (3) **Radio Shack Math/Science-Formula EC-4024.** Features 23 built-in formulas for math, statistics, physics, electronics/electricity. Add two of your own equations with a total of 29 steps. Large 10-digit display has alphabetic prompt for formula use. Has nine physical constants. Dual powered. $5\frac{1}{2} \times 2\frac{7}{8} \times \frac{3}{8}$ " . With lithium battery. 65-991 **34.95**
- (4) **NEW! Radio Shack EC-4032.** Full-featured 91-function scientific. Performs paired variable statistics, trig functions and base-*n* math. Seven memories. Random number generator. Dual powered. 10-digit mantissa, 2-digit exponent. $5\frac{3}{8} \times 3 \times \frac{5}{8}$ " . With lithium battery, case. 65-998 **21.95**
- (5) **Radio Shack EC-4021.** Programmable 40-step scientific. Design your own "special application" calculator by programming formulas you use frequently. 46 functions. 8-digit mantissa, 2-digit exponent. $5\frac{1}{2} \times 3 \times 1\frac{1}{8}$ " . With case, 2 RS357A batteries. Was \$19.95 in the 1992 Catalog. 65-984 **New Low Price! 17.95**
- (6) **NEW! Radio Shack EC-4028.** Features 56 scientific functions including trig, statistics and base-*n* math. 10-digit mantissa, 2-digit exponent. $5\frac{3}{8} \times 2\frac{7}{8} \times \frac{3}{8}$ " . With case and RS389 battery. 65-815 **14.95**
- (7) **Radio Shack EC-4008.** Great value in a scientific! Forty single-function keys. 5-digit mantissa, 2-digit exponent. $4\frac{3}{8} \times 2\frac{1}{2} \times \frac{1}{4}$ " . With case, 2 RS357A batteries. Was \$13.95 in 1992 Catalog. 65-977 **New Low Price! 12.95**

Programmed for Business Analysis

Radio Shack EC-5100. Built-in formulas provide quick, easy solutions for problems in real estate, investments and more. $5\frac{1}{4} \times 2\frac{3}{4} \times \frac{3}{8}$ " . With 2 RS357 batteries, 175-page manual. Was \$34.95 in 1992 Catalog. 65-875 **29.95**



The Preferred Choice of Business Majors

Radio Shack EC-5010. Functions for calculating simple/compound interest, rate conversions, amortization, much more. $5\frac{1}{8} \times 2\frac{3}{4} \times \frac{3}{8}$ " . With 2 RS357 batteries, case. Was \$24.95 in 1992 Catalog. 65-870 **21.95**



Solar-Power Calculator for Yard/Foot/Inch

Radio Shack EC-317. No need to convert yards, feet and inches to a single measure! Just enter 30 feet, 8 inches; multiply by 18 feet $3\frac{3}{4}$ inches to get the answer—561.583 square feet. $5\frac{1}{8} \times 2\frac{3}{4} \times \frac{3}{8}$ " . 65-935 **29.95**



Solar-Power Calculator With Metric Conversions

Radio Shack EC-318. Performs 22 conversions to and from metric. Includes conversion functions for weight, volume, distance and temperature. Has 3-key memory and percent keys. $4\frac{1}{8} \times 3 \times \frac{1}{4}$ " . With bill-fold case. 65-931 **14.95**

Calculator Desk Stand. (Not shown.) 65-705 **2.49**



ALL CALCULATORS ON THESE TWO PAGES HAVE LCD DISPLAYS FOR LONGEST BATTERY LIFE

**Simplify your life!
Manage your
time and data
with an electronic
organizer**



New! Rolodex Pocket Planner

Radio Shack EC-334. Combines the practicality of a paper planner with the efficiency of an electronic directory. Directory stores up to 110 names/numbers, recalls items by scrolling or instantly with "search." Planner organizes appointments, reminders. Calculator, time-zone map, conversions for US/metric. $3 \times 4\frac{3}{4} \times 3\frac{3}{4}$ " (folded). With CR1616 battery. **65-855 19.95**



New! Rolodex Executive Planner, The Common-Sense Breakthrough

Radio Shack EC-335. Combines an easy-to-use electronic directory with the most practical paper planner you've ever used. 48K directory stores up to 800 comprehensive entries. Planner organizes your calendar—appointments, reminders, anniversaries. Infrared transmitter for sharing data with another Executive Planner. $4 \times 6\frac{5}{8} \times 3\frac{3}{4}$ " (folded). Genuine kid-leather case. With CR2430 and CR1616 batteries. (TSP) **65-856 99.95**



(1)



(3)



New! Data Directory and Scheduler

Radio Shack EC-336. A pocket planner that helps you manage time, money and information. Stores up to 500 names/numbers with instant recall of stored listings. Scheduler with alarm keeps you on time for appointments. 12-digit calculator, clock/calendar, up/down timer, currency exchanger. Stores balances of up to six bank or credit card accounts. $2\frac{9}{16} \times 4\frac{1}{8} \times 1\frac{1}{4}$ ". With CR2032 battery. **65-857 29.95**



(2)

Enjoy Instant Access to Information You Need for Daily Business Tasks

(1) EC-331 Data Organizer/Scheduler. This super value has a phone directory, scheduler with alarm, memo file, count-up/down timer, 12-digit calculator, clock/calendar and a special memory for holding the balances of up to six bank or credit-card accounts. Stores over 100 names/numbers. $3\frac{3}{8} \times 2\frac{1}{8} \times 1\frac{1}{4}$ ". With 2 CR2016 batteries. **65-948, 19.95**

(2) EC-328 Calculator With Data Memory. Full-function calculator plus an easy-to-use data directory. Stores up to 50 names in alphabetical order, making it easy to find a name by scrolling. Or use search function to locate an item instantly. Foreign currency exchanger and metric conversion. $2\frac{1}{2} \times 3\frac{7}{8} \times 3\frac{3}{8}$ ". With CR2025 battery. **65-944, 12.95**

(3) EC-333 Rolodex Directory Telephone Dialer. An incredibly efficient combination data organizer and speed dialer! Stores up to 1000 names and phone numbers—instantly recalls any entry, then dials the number with just the touch of a button. Entries are automatically alphabetized and can be recalled by either the person's name or company name. Or quickly flip through the list using one of two Rolodex knobs. Up to 30 lines per entry for adding an address and other information. Special file lets you write yourself memos which appear on future dates. Built-in calendar, clock, calculator. $7\frac{3}{4} \times 6\frac{1}{2} \times 4\frac{1}{16}$ ". Requires 4 "AA" batteries. Was \$89.95 in 1992 Catalog. (TSP) **65-950 New Low Price! 69.95**

**“Take-charge”
business tools!
Keep important
information at your
fingertips**



Built-in IR transmitter lets you transfer data between any two compatible Rolodex directories in seconds.

Rolodex® Desktop Directory

(5) **Radio Shack EC-340.** 64K memory stores up to 500 records alphabetically with up to 60 lines of information per record! Four filing categories with automatic data transfer between files. Scroll through records by turning one of two Rolodex knobs or use search function to find any record instantly. Calendar, currency exchanger, PC communication link. 10 x 9 x 9". Requires 4 "AA" batteries or AC adapter. (TSP) 65-940 . . . 149.95

Rolodex Pocket Directory

(6) **Radio Shack EC-339.** Ideal traveling companion. Pocket-size data organizer has all the power and features of EC-340 above, including 64K memory, but without the Rolodex knobs. PC communication link for sharing data with compatible computer (requires interface, CMC). 2 1/2 x 4 1/4 x 5/8" (folded). With CR2016 and 2 CR2430 batteries. (TSP) 65-939 99.95
Interface for EC-340/EC-339. Optically links Rolodex models above to PC for data sharing. (CMC) 65-132 69.95

Radio Shack Combination Information Systems/Schedule Planners

(1) **Radio Shack EC-332.** So sophisticated it's a cinch to use! Scheduler with alarm. 64K directory stores 1000 comprehensive entries—name, phone number, address, space for notes. World-time clock, calendar, currency converter. 3 1/4 x 6 1/8 x 7/8" (folded). Requires 2 "AAA" batteries, includes CR2016 backup battery. Was \$139.95 in 1992 Catalog. (TSP) 65-949 **New Low Price! 129.95**
Interface Cable. Connects two EC-332s. (CMC) 65-133, 5.95
(2) **Radio Shack EC-330.** Pocket powerhouse stores more than 800 comprehensive entries. Scheduler alarm, memo pad, anniversary reminder, calendar, calculator. Communication link. 3 1/4 x 5 3/4 x 1/2" (folded). With 3 CR2032 batteries. Was \$99.95 in 1992 Catalog. (TSP) 65-947, **New Low Price! 89.95**
Interface Cable. Connects two EC-330s. (CMC) 65-136, 34.99

(3) **Radio Shack EC-327.** So convenient, so easy to use it will spoil you! Entries are filed and recalled for you automatically. 34K memory stores over 500 comprehensive entries. Scheduler with alarm, memo pad, world-time clock, communication link. 2 1/2 x 5 3/4 x 3/4" (folded). Requires 2 "AAA" batteries, includes CR1616 backup battery. Was \$69.95 in 1992 Catalog. (TSP) 65-943 **New Low Price! 59.95**
Interface Cable. Connects two EC-327s. (CMC) 65-133, 5.95
(4) **Radio Shack EC-329.** Three individual directories keep your business and personal phone numbers separated. Stores 250 names/numbers. Scheduler with alarm. Clock, calendar, calculator, communication link. 3 3/8 x 5 1/4 x 1/2" (folded). Includes CR2025 operating/backup batteries. 65-946 39.95
Interface Cable. Connects two EC-329s. (CMC) 65-134, 24.99
Interface Cable. EC-329 to EC-330. (CMC) 65-135 49.99

Tandy notebook PCs: Innovation in engineering since 1983

Since 1983, when we introduced our acclaimed Model 100, Tandy has been the one to consider first for portable computing. Built for lasting performance and quality-tested to stand up to rugged handling, Tandy notebook PCs make it easy to travel light. Since they're PC compatible, you can choose from thousands of powerful and popular software titles. And every Tandy notebook PC comes ready to run with software already installed on the hard drive. Just turn them on, and you're ready to go . . . anywhere!

F.Y.I.

Since notebooks are meant for work on the go, we design our portable PCs with special power-saving features. The Tandy notebook PCs displayed to the right all feature **Tandy PowerCheck** indicators so you can check power and battery status even with the lid closed. This knowledge helps you to conserve power. With the Tandy 3830 SL, you can shut off in the middle of a program and a special **Resume Mode** will take you right back to where you left off. Plus, an **Automatic Shut Down** feature helps conserve battery life. For power-saving design, look to Tandy—there really is a difference!

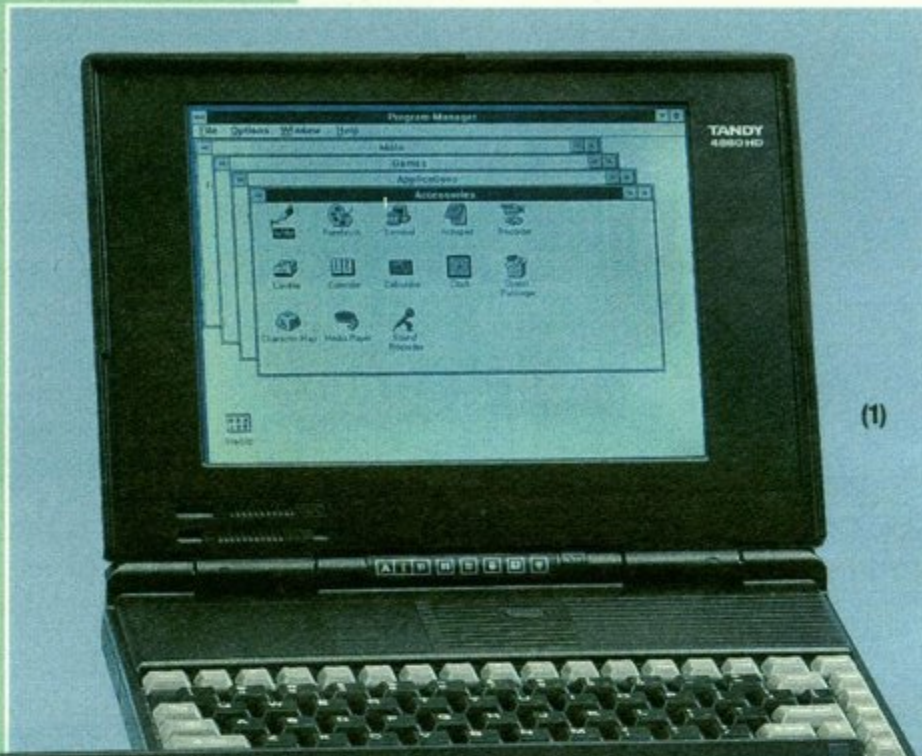

(1)

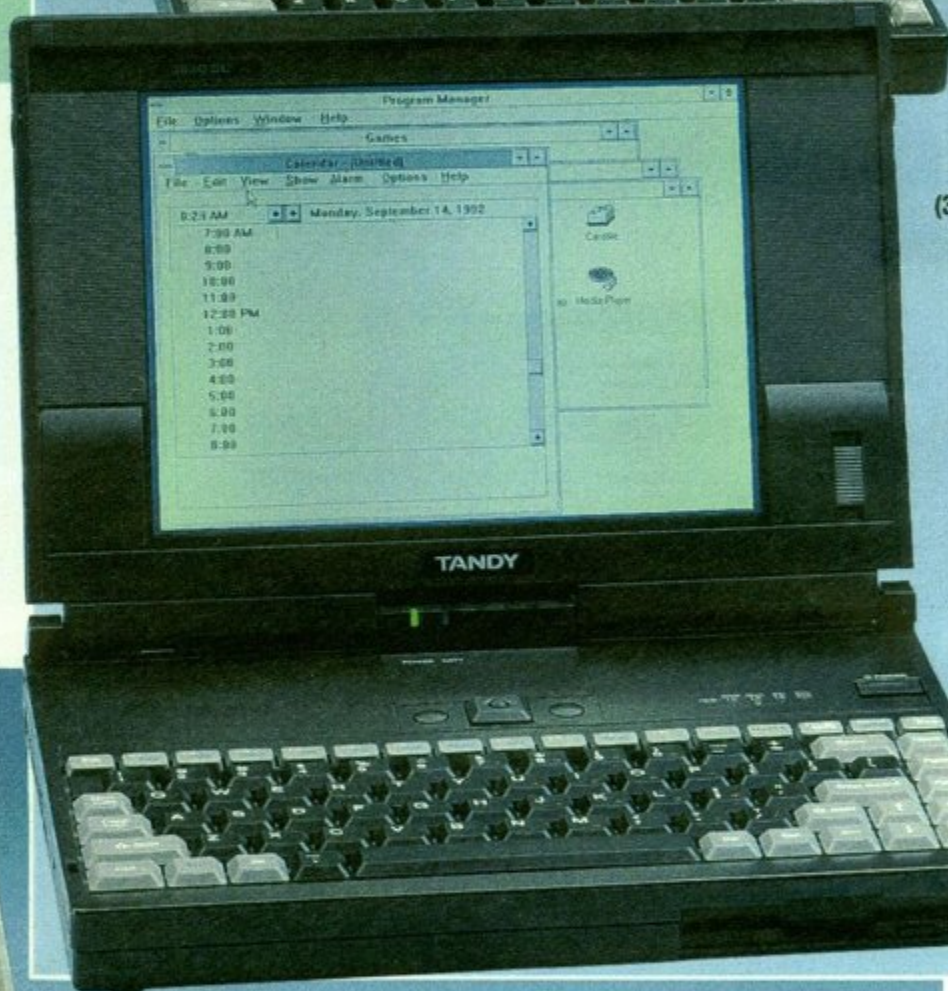

(3)



Tandy 1110 HD. The perfect entry point for notebook computing! The 1110 HD's 20MB hard drive comes with MS-DOS 5.0 and DeskMate software pre-installed. Just turn it on, and you're ready to run! DeskMate organizes your programs and guides you through tasks using plain-English commands. Get right to work with word processing, a worksheet, filer and six other handy programs. With the 1110 HD's built-in floppy drive, you can also use today's industry-standard PC software. The removable, rechargeable battery gives you up to 3½ hours of power between charges. Compact size and light weight (only 6.6 lbs.) make it the perfect choice for students, writers and busy executives. (TSP) 25-3531 999.00

Get right to work with built-in Windows™ software and large-capacity hard drives



These powerful notebooks are loaded and ready to go with the most popular graphical user interface available—Microsoft Windows. You'll be ready to run thousands of powerful Windows-based applications with ease. Windows' graphical environment gives you the ability to work with all your applications within an exciting visual environment.

We've packed these notebooks with powerful hard drives of 60 megabytes or more, plenty of room to store Windows applications and data. That's something standard 40MB hard drives just can't do.

And each of these PCs features standard VGA graphics for "knock-your-eyes-out" graphs, pictures and charts.

Perfect for the office, at home and on the road, these notebooks are also powerful enough to support a full desktop system. It's computing power you never thought possible in a portable.

(1) NEW! Tandy 4860 HD. Get the fastest desktop power in a notebook computer. The 4860 HD's i486™DX microprocessor runs at an incredible 33MHz clock speed. With its built-in math coprocessor and 8K RAM cache, you'll zoom through programs at up to 70% faster than 33MHz 386 machines. And with a 60MB hard drive and 4MB of memory, you get plenty of room to store Windows applications and data. (TSP) **25-3540** **3499.00***

(2) NEW! Tandy 4800 HD. This i486SX-based system runs at 20MHz for users with large jobs and tight budgets. Featuring the same rugged case as the Tandy 4860 HD, the 4800 HD comes with a 60MB hard drive and 4MB memory. (TSP) **25-3539** **2999.00***

(3) NEW! Tandy 3830 SL. Get 386 performance in a notebook PC weighing under 6 lbs. Engineered for the smallest format possible, the 3830 SL runs at a fast 25MHz. The low-power-consumption design of its i386™SL microprocessor extends battery life, plus the system uses long-life Nickel Metal Hydride batteries. A built-in Mini-Track Ball is provided as a pointing device. 80MB hard drive, 2MB memory. (TSP) **25-3573** **2999.00***

(4) NEW! Tandy 3800 HD. Get super performance in an affordable notebook PC. The 3800 HD features the unique Cx486SLC processor operating at a speedy 20MHz. A high-capacity 60MB hard drive is included for large Windows-based programs and data. 2MB RAM. (TSP) **25-3533** **1999.00***



(1) Universal Carry Case. Two outside pockets for accessories. 25-3512 39.95
(2) Leather Carry Case. Good-looking, padded, secure. 25-3518 99.95*
Hard Shell Case. (Not shown.) 25-3519 CMC, 89.95

Memory Upgrade Kits

- 2MB. For Tandy 1800 HD/3800 HD. 25-3504, 259.95*
- 1MB. For Tandy 1500/2810/3810. 25-3507, 249.95*
- 2MB. For Tandy 2820/3820/3830. 25-3508, 399.95*
- 6MB. For Tandy 3820 HD/3830 SL. 25-3527, 1099.00*
- 4MB. For Tandy 4800/4860 HD. 25-3543, 399.95*
- 1MB. For Tandy 2800 HD. 25-3554 399.95*

Modems

- 2400 BPS.
For Tandy 1100 FD/1110 HD. 25-3538 199.95*
- 2400 BPS/9600 Send Fax.
For Tandy 1500/1800/2810/2820/
3800/3810/3820/3830. 25-3509 199.95*
- 2400 BPS/9600 Send/Receive Fax.
For Tandy 4800/4860 HD. 25-3542 299.95*
- 2400 BPS. For Tandy 2800 HD. 25-3555, 199.95*

Replacement Batteries

- For Tandy 1400 LT. 25-3520 79.95*
- For Tandy 1400FD/1400 HD. 25-3521 79.95
- For Tandy 1500/1800/2810/2820/
3800/3810/3820 HD. 25-3526 99.95*
- For Tandy 1100 FD/1100 HD. 25-3536 29.95
- For Tandy 3830 SL. 25-3579 199.95*
- For Tandy 4800/4860 HD. 25-3541 109.95*
- For Tandy 2800 HD. 25-3556 49.95*

Handy Accessories

- Battery Charger.** For 25-3526 batteries. Requires AC adapter. Charges two batteries. 25-3537 229.95*
- Mini-Trackball.** For Tandy 4800/4860 HD. 25-3545 99.95*
- Docking Station.** For Tandy 3830 SL. Room for 2 PC boards. Keyboard, video, serial ports. 25-3583 699.95*

Enhance your PC with the point-and-click simplicity of Microsoft® Windows™

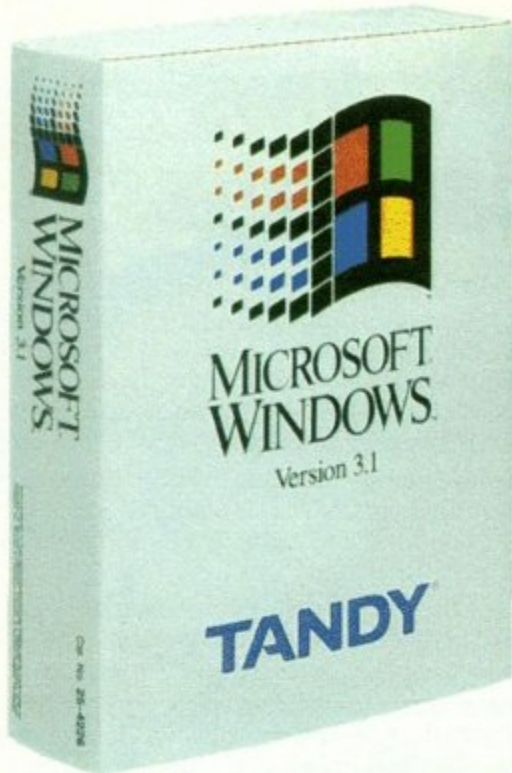

Novice or Power Users Can Gain Simple, Easy Access to Powerful PC Features

NEW! Windows 3.1. The Microsoft Windows operating environment makes using PCs easier for everyone. It eliminates the intimidation factor many users experience with the MS-DOS operating system by simplifying many common tasks.

Easy to Install, Learn and Use. Improved Setup automatically loads the Windows operating environment onto your PC. Computer-based Tutorial teaches you how to use a mouse and quickly trains you on basic concepts. Windows drop-down menus all look and work alike. Learn a few basic concepts, and you'll know how to use Windows and any application for Windows. Online Help, accessible from anywhere in Windows, provides information at the touch of a button.

Works Great With MS-DOS and Windows Applications. The Windows operating environment automatically recognizes and sets up most MS-DOS-based applications. You can easily use the same data in a variety of applications by using the mouse to copy and paste information into other applications. Object linking and embedding (OLE) technology allows you to keep information current across applications, simply by changing the information in any one of them.

A Fast, Reliable Operating Environment. More efficient memory use lets you break the old 640K memory constraints of MS-DOS-based applications by running them under Windows. And with an 80386 or later machine, you can even use hard disk space as additional memory. You can run as many applications as your system can handle at one time. You can switch back and forth among applications quickly and move information easily from one to another.

Technical Features. Improved SmartDrive doubles disk access speed. Enhanced Program Information Files (PIFs) optimize performance of standard MS-DOS-based applications running with Windows. Application Reboot keeps Windows and other applications running while you reboot a problem application. Dr. Watson program monitors applications and logs any problems to your hard disk so you can pinpoint the source of difficulty. Desktop applications include Terminal, Calendar, Calculator, Recorder, Clock, Cardfile and Notepad.

Minimum System Requirements. 80286 CPU, 1MB RAM (2MB recommended), hard drive, EGA, and a mouse. 25-4226 149.95



NEW! Screen Craze. Three programs in one! Screen Saver detects PC inactivity and displays amusing animations, scrolling messages or animated logos, saving your monitor from costly and annoying "burn-in." Windows Wallpaper Animator jazzes up your Windows background with entertaining animations. ScreenCraze Editor lets you customize your own screen savers or wallpapers. 25-1444 49.95

NEW! Icon Do-It. Replace your Windows icons and cursors. Choose from 200 designer and 15 animated icons, plus 50 custom and 5 animated cursors. It's fast and easy with the point-and-click interface. Also features four spectacular screen savers. 25-1902 29.95

NEW! Diet Pro for Windows. Complete nutrient, diet and exercise balancer. Track 36 nutrients in every food in the USDA food list, plus fast foods, prepared foods, specialty items and your own foods. Measure your dietary intake against the standard RDAs. Develop a weight loss and fitness plan uniquely tailored to your lifestyle. 25-1907 59.95

NEW! Quicken for Windows. Painlessly organize and manage all of your personal or small business finances with the most popular and most trusted finance software. Quicken looks just like your checkbook, so you already know how to use it. Tracks checking, savings, credit cards, investments, cash, assets and liabilities. Pays bills by modem through CheckFree™, the nation's leading electronic payment service (CheckFree software is included at no charge). 25-1473 69.95

NEW! Money Manager for Windows. Organize your finances without learning accounting! Balance your checkbook easily with the simple walk-through bank reconciliation. Set up unlimited household or office accounts. Prints a variety of reports including income and expense summaries. Features investment analysis for future value of deposits, loan/mortgage calculation and amortization schedules. Extensive online help. 25-1909 29.95

NEW! The Far Side Computer Calendar. A perpetual calendar and full-featured desktop organizer with cartoons based on the bizarre world of Gary Larson. Plan and view your schedule by the day, week, month or year. Program recurring events. Set audio alarms to alert you of your next appointment. Animated icons even provide visual reminders of your day. Print calendars in a variety of sizes. 25-1911 59.95

NEW! AllFonts for Home. Features 12 scalable type families specially selected for use in creating eye-catching personal letters, notes, signs, pamphlets and more. Each typeface includes the complete international character set. No additional software needed to use with Windows 3.1 and your favorite word processor. 25-1913 49.95

NEW! Draw 'N Publish. Create organizational charts, maps, logos, signs and more. Wrap text around curves, create gradient styles, slant text and graphics, blend objects and colors. Includes 200 ready-to-use ClipArt images. Add your designs to word processor or desktop publishing programs, and print in color or black and white directly to any Windows output device. 25-1914 49.95

DeskMate Programs That Will Increase Your Personal Productivity

DeskMate 3. Ten useful applications for Tandy and other PC-compatible computers. Pull-down menus and pop-up dialog boxes guide you through tasks quickly. It's simple to use other DeskMate programs because all commands are similar. Built-in tutorial will have you up and running in no time and a help function is available anywhere in DeskMate for on-the-spot directions.

25-1351 99.95

Spanish Version of DeskMate.

25-1355 99.95

DeskMate Personal Financial Assistant.

Organize your personal finances, create a budget, track your investments and more. Find out where your money is really going.

25-1366 19.95

CheckFree DeskMate.

A convenient personal electronic banking service that lets you pay your bills and take care of financial transactions in just minutes. Requires modem.

25-1367 19.95

DeskMate Home Lawyer.

Handles important matters like wills and power of attorney. Prints a variety of the most frequently used legal documents. Requires 640K RAM.

25-1434 69.95

DeskMate Express Publisher.

Features crisp 300-dpi text and graphics, scalable fonts, advanced layout tools and more. Requires 640K RAM, hard drive and mouse.

25-1438 99.00

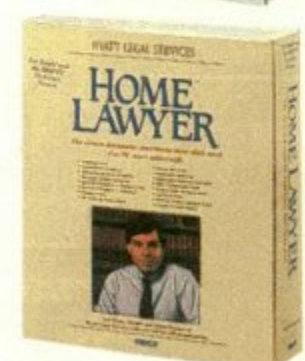
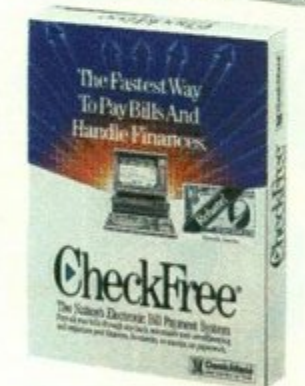
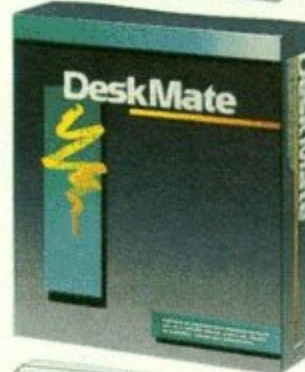
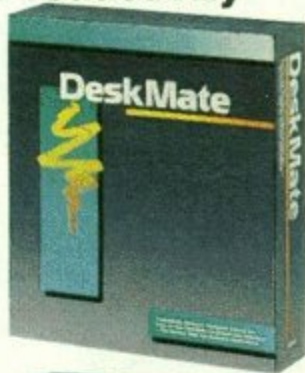

Whatever your interests, we stock the programs for your home or office PC

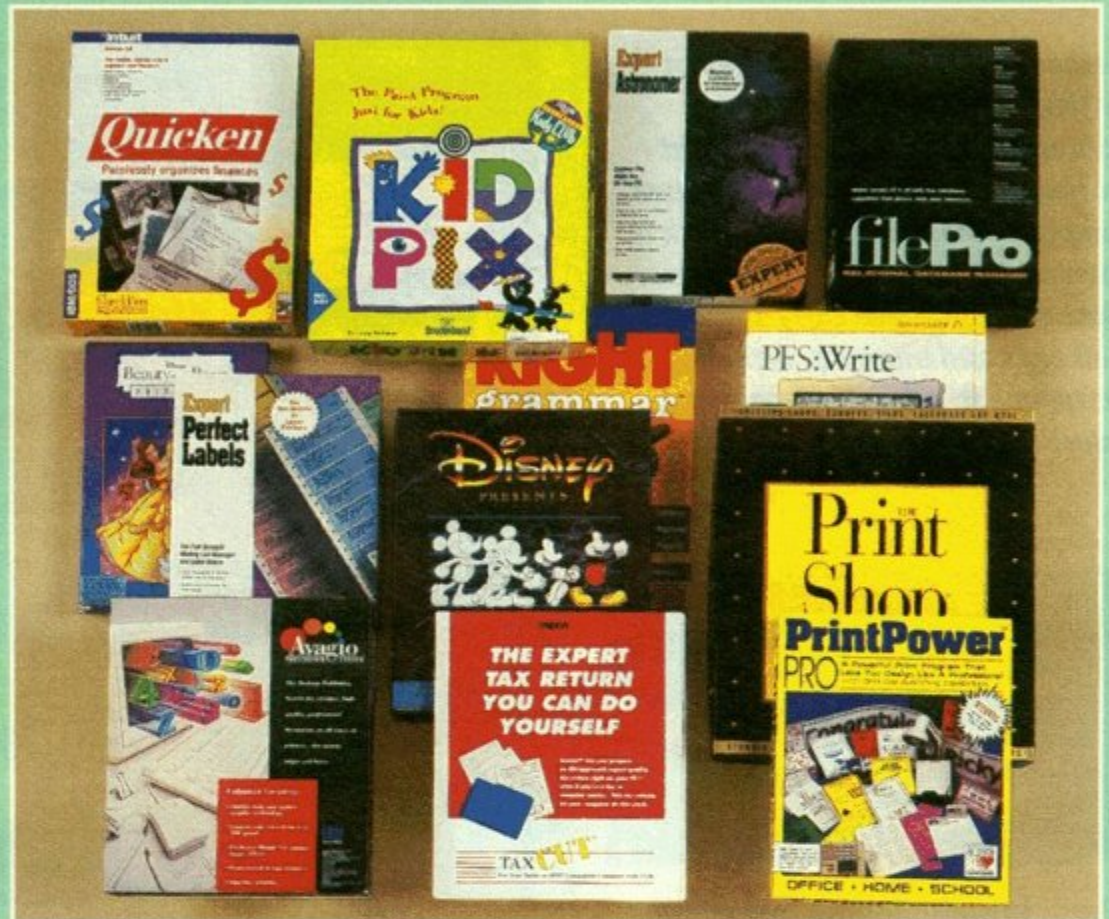

NEW! Lotus 1-2-3 for Home. Full Lotus program with limited size spreadsheet. 25-1918 .. 99.95

NEW! Quicken 5.0. Know how much money you have and where it goes. 25-1446 59.95

NEW! Kid Pix. The kids don't just paint a work of art—they hear it! Every brush and tool has its own unique sound. Stamps and rub-in images help the very young artist. Requires 640K, VGA, hard drive and mouse. 25-1447, 59.95

NEW! Astronomer. Explore the night sky on your PC. Discover the name of any celestial object, locate any object by name and more. Includes excellent beginner's guide to astronomy. 25-1449 14.95

NEW! FilePro. Access data in multiple files, copy screens from or to any file, review or copy data from one file while working on another, and more. Requires 640K, hard drive. 25-1903 99.00

NEW! Beauty and the Beast Print Kit. Create your own greeting cards, invitations, bookmarks, posters, calendars, place mats and more. 25-1904 19.95

NEW! RightGrammar. Works with your word processor to proofread your work for thousands of common writing errors, then highlights mistakes and suggests alternative words, punctuation and grammar. Requires two floppy drives or hard drive. 25-1905 .. 29.95

NEW! PFS:Write. A powerful word processor that features "what-you-see-is-what-you-get" editing, scalable fonts, columns, boxes, lines, spell checker, thesaurus, grammar and style checker, clip art and more. Requires 640K and hard drive. 25-1912 99.95

NEW! Perfect Labels. A full-featured mailing list manager and label maker. Checks for duplicate records, imports records in dBase or text format, sorts by name or by zip for bulk mailing, and more. 25-1908 14.95

NEW! Disney's The Animation Studio. The only full-featured program to utilize state-of-the-art cel animation techniques. See the cel you're working on and the three cels behind it, order cels any way you like and control the timing of each, add sound effects, add color, and much more. Fully compatible with the popular image and animation formats. Requires 640K and mouse. 25-1445 129.95

NEW! The Print Shop Deluxe. Combine stunning graphics and stylish text like never before. Choose from over 300 graphics, 20 fonts, dozens of layouts and more. Requires 386SX, 1MB RAM, hard drive, 3 1/2" 720K or 5 1/4" 1.2MB floppy drive, and VGA. 25-1917, 79.95

Avagio Publishing System. Professional design features include kerning, leading, automatic text wrap, and more. Import spreadsheet graphs, text and clip-art from other files. With graphics library and templates. Requires 640K, hard drive and mouse. 25-1425 99.95

TaxCut. Makes tax preparation easy. TaxCut audits your return for deductions you may have missed and entries which may trigger an IRS red flag. 25-1431 59.95

PrintPower PRO. Create banners, greeting cards, calendars, stationery and more—just like a professional designer! Best of all, there is complete character editing, allowing you to use a variety of features and fonts. 25-1437 24.95

Your search for popular programs is over... we have them!

Whether you're looking for the hot new titles or the tried-and-true favorites, they're waiting for you at your neighborhood Radio Shack. Just a sample of the programs we stock is shown at right, and new ones arrive almost every day. We carry software for all ages and interests, including entertainment, education, personal productivity and business.



New! Introducing an Incredible Piano Teaching Method

The Miracle Piano Teaching System™. The truly amazing Miracle system makes learning to play the piano faster, easier and more enjoyable than ever before—your age doesn't matter and no musical experience is required. The Miracle is designed to work with a PC-compatible computer, then using Artificial Intelligence, it monitors your progress and custom designs a library of personal exercises just for you. That way you're really "playing to learn" instead of "learning to play!" Entertaining video games teach notes, chords, sight reading, music theory and more. Now you can see why these features are quickly making The Miracle the most popular keyboard learning method available. Plays up to 16 notes and eight instruments at once through its built-in 4" stereo speakers, included headphones or your stereo system. Has 128 instrument sounds, 49 full-size velocity-sensitive keys with split-keyboard effects, a volume control, sustain pedal and built-in metronome. MIDI compatible. UL listed AC adapter. (TSP)

25-1821 399.95

NEW! Miracle Keyboard Song Collections. Now there are 80 more ways of playing to learn instead of learning to play! Each volume contains 40 great songs chosen to represent a wide variety of popular musical styles—Rock and Roll, Country, Pop, Rhythm and Blues. Just pick the tune, and in no time at all you're playing it like a pro! All songs are fully arranged so that along with your performance you can hear a complete accompaniment. Best of all, each song is arranged for two levels of playing difficulty—novice and expert. It's like turning a piano lesson into a jam session!

Volume 1. 25-1915 49.95

Volume 2. 25-1916 49.95



MicroProse
New!
Land/Sea/Air 2
25-1830 59.95

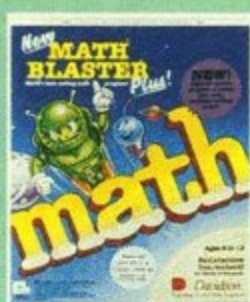

Davidson
New!
Math Blaster Plus
25-1380 49.95

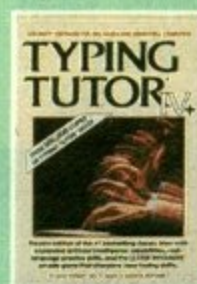

Simon and Schuster
Typing Tutor IV
for DeskMate
25-1818 49.95

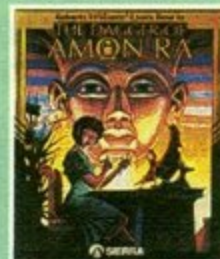

Sierra
New!
Laura Bow Mystery
25-1836 59.95

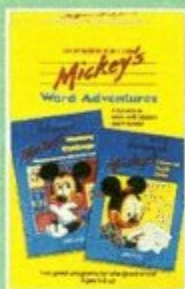

Disney
New!
Mickey's Fun
With Words
25-1833 39.95

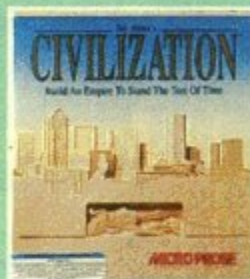

MicroProse
New!
Sid Meier's
Civilization
25-1825 59.95



Access
New!
Links 386 with
Barton Creek Course
25-1841 89.95



Sierra
Space Quest IV:
Roger Wilco
25-1807 49.95



Origin
New!
Strike Commander
25-1842 79.95

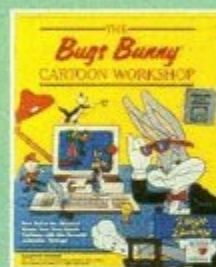

Hi-Tech
Bugs Bunny
Cartoon Workshop
25-1803 39.95

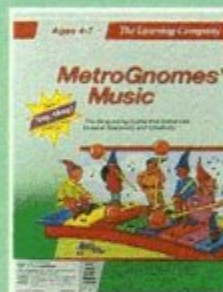

Learning Company
New!
Metrognomes
25-1835 49.95

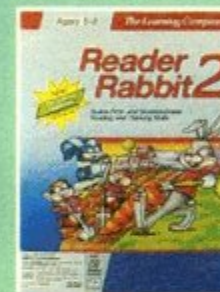

Learning Company
New!
Reader Rabbit 2
25-1834 59.95



CyberDream
New!
Darkseed
25-1828 59.95

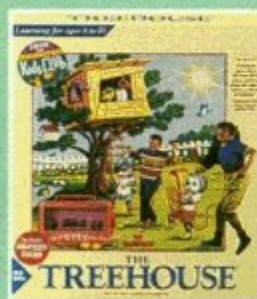

Broderbund
The Treehouse
25-1820 49.95

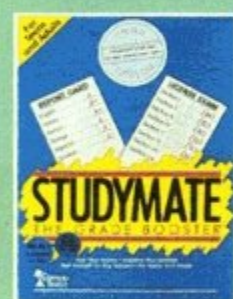

Compu Teach
StudyMate
25-1827 49.95

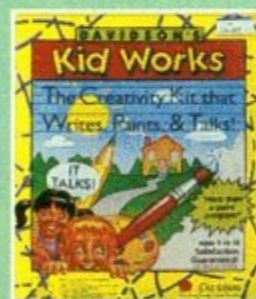

Davidson
New!
Kidworks
25-1900 49.95

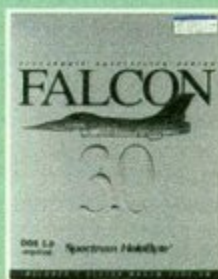

Spectrum Holobyte
New!
Falcon 3.0
(MS-DOS 5.0 or
higher required)
25-1837 59.95

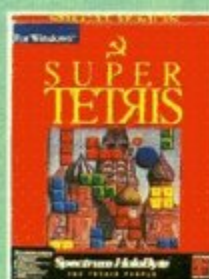

Spectrum Holobyte
New!
Super Tetris
for Windows (3.0
or higher required)
25-1838 49.95



Broderbund
Where in America's
Past is
Carmen Sandiego?
25-1802 49.95

A network office solution helps A people & PCs work together... saving time, effort and money

What is a network? A network is two or more personal computers that are connected together.

Why use a network? A network is ideal when more than one person needs to have access to the same information. Networking also lets you share expensive peripherals like laser printers and hard drives.

How does it work? There are three components of a network: hardware, cable and software. First, each PC on the network must have an interface card (the hardware) to allow the computers to talk to each other, and interface cards use

different "protocols" in order to communicate. Next, the cable connects the computers together. Finally, the software is the "traffic director" and is responsible for security, messaging, and the sharing of peripherals.

What kind of network do you need? One of our professionals can help you make the right choice—and Radio Shack is an authorized dealer for Novell Netware, the industry leader.



Networking Products That Help You Make the Right Connection

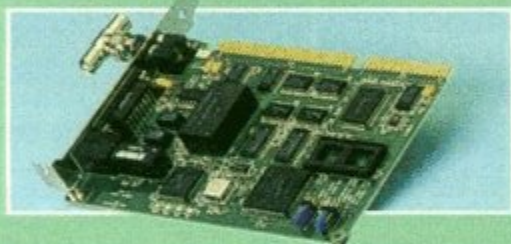

EtherNet

The EtherNet standard is the most popular local area network on the market today. This high-throughput network supports Novell and LANtastic/AI operating systems and can operate at speeds up to 10 megabits per second over a coaxial or twisted-pair cable. Radio Shack has everything you need.

NEW! Tandy EtherNet Twisted Pair Adapter. An 8-bit, half-size card. 26-5504 249.95*

Tandy EtherNet Adapter. An 8-bit, half-size adapter, with BNC connector. 26-5505 249.95*

NEW! Tandy EtherNet Plus-16 Combo Adapter. An 8/16-bit card that features twisted-pair, BNC and AUI wiring connectors. 26-5508 299.95*

Thin EtherNet Coaxial Cable Assemblies. RG-58 A/U cable assembly with two BNC connectors installed.

6-Ft. 26-5529 10.95*

10-Ft. 26-5527 12.95*

20-Ft. 26-5530 15.95*

50-Ft. 26-5531 24.95*

100-Ft. 26-5532 39.95*

Thin EtherNet RG-58 PVC Cable (Bulk). 26-5533 Per Foot/.22*

Thin EtherNet RG-58 Plenum Cable (Bulk). 26-5535 Per Foot/.99*

Crimp-On Thin EtherNet BNC Connectors (2). For RG-58 A/U or P/U PVC coaxial cable.

26-5528 5.95*

Crimp-On Plenum BNC Connectors (2). For RG-58 A/U or C/U Plenum coaxial cable.

26-5538 5.95*

BNC Terminator Kit. 26-5534 29.95*

Twisted-Pair EtherNet Cable. A 4-pair unshielded twisted-pair (UTP) cable with two male RJ-45 connectors installed.

10-Ft. Assembly. 26-5545 13.95*

25-Ft. Assembly. 26-5546 21.95*

ARCNET

A cost-effective local area network (2.5 megabits per second) that supports Novell and LANtastic/AI network operating systems. This proven, deterministic network is easy to install and expand.

Tandy ARCNET Adapter. An 8-bit, half-size card designed to operate with any Tandy PC-compatible system. May be used with EGA adapters and expanded memory boards without conflict.

26-6505 199.95*

ARCNET Passive Hub. A four-port hub used for ARCNET RG-62-type cable. The maximum distance from each port is 100 feet. 26-6504, 69.95*

ARCNET Coaxial Cable Assemblies. RG-62 cable with connector on each end.

6-Ft. 26-6516 9.95*

10-Ft. 26-6517 10.95*

20-Ft. 26-6510 18.95*

100-Ft. 26-6512 39.95*

Bulk. 26-6513 Per Foot/.22*



TandyLink

An entry-level local area network that supports the LANtastic/AI network operating system.

TandyLink PC Adapter. 26-5601 99.95*

TandyLink Plus Adapter. For the Tandy 1000 HX. 26-5602 99.95*

TandyLink Cables. Shielded, twisted-pair cable with two 3-pin DIN plugs installed.

6-Ft. 26-5610 9.95*

20-Ft. 26-5612 16.95*

50-Ft. 26-5611 24.95*

TandyLink Cable Extender. 26-5615 7.95*

LANtastic /AI Network Operating System



For anyone who believes that all big-capability PC networks demand big bucks, big hassles and big RAM, we offer the LANtastic/AI Network Operating System. LANtastic/AI gives you a long list of powerful features at a price even the smallest installation can afford. LANtastic/AI is truly a breakthrough in LAN affordability and simplicity.

Because LANtastic/AI is a peer-to-peer network, any machine can be a server, a workstation, or both. LANtastic/AI eliminates the expense of a dedicated machine, requires less time to set up, and is easier to understand. It has made networking economically viable in a much wider range of applications, even in installations with only two machines. Other features include Electronic Mail with pop-up notification and chat, unsurpassed ability to support CD-ROM drives, built-in security to protect data and disk cache to boost network speed.

LANtastic's installation program automatically installs your network software, so you can be up and running in minutes. And LANtastic/AI uses less RAM than any other LAN. Requires one package for each PC in the network.

25-4220 99.95

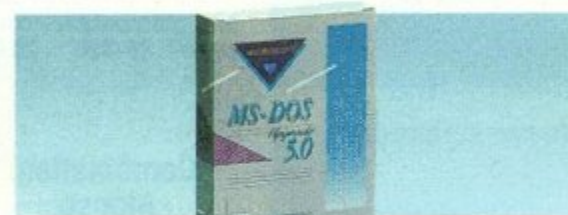

Microsoft MS-DOS 5.0 Upgrade

- Most significant new version of DOS in years
- Drop-down menus to browse through options
- Online help guides you through any command
- Recover accidentally deleted files
- Full-screen editor with pull-down menus
- Task swapper switches between applications
- DOS key lets you select frequent commands
- Reformat disks in 80% less time
- New QBasic interpreter for faster programming
- New setup program for automatic installation
- Includes file transfer utilities

MS-DOS 5.0—the best DOS ever! It offers something for everyone, from the novice to the power user. It provides applications with more memory, is easier to use and gives DOS applications new life under the Microsoft Windows graphical environment. It actually turns MS-DOS into a productivity tool!

MS-DOS Gives Applications More Room to Work			
MS-DOS Version	Maximum Free Conventional Memory*	MS-DOS Version	Maximum Free Conventional Memory on a Networked PC**
5.0	621K	5.0	613K
4.01	565K	4.01	480K
3.3	575K	3.3	490K

*On an 80286, 80386 or 80486 PC with at least 64K of extended memory.
**The numbers given are specific to a particular 386 system. These numbers vary on different hardware and software configurations.

MS-DOS 5.0 Upgrade. Complete MS-DOS 5.0 package to upgrade from MS-DOS 2.x, 3.x and 4.x. Dual-media, non-bootable file system requires MS-DOS for installation. 25-4176 69.95

MS-DOS 5.0 Documentation Set. Includes Microsoft User Guide and Reference. 25-4177 21.95

Pistol-Grip Joystick

Our best! Gives you a better grip and faster, more accurate response. Self-centering. Two buttons on base. For Tandy 1000-series and Color Computer 3. 26-3123 29.95

Joystick for Apple®/IBM®

This high-speed auto-firing joystick features both free-floating and auto-centering modes. Has 15 and 9-pin connectors. IBM XT and Apple IIe/c compatible. 270-1707 .. 24.95

High-Speed Game Card

NEW! Accommodates speeds from 4.77 to 35MHz. Compatible with all Tandy, IBM PC, XT, AT, PS/2 Models 25 and 30, Compaq® 386 and compatible computers. 26-328 29.95

Combination Mouse

Supports PS/2-style and DB-9 serial ports. Two-button operation and accurate cursor movement. Ideal for Desk-Mate, Windows and other graphics programs. 25-2001 39.95

Mouse Pad

Keeps the tracking ball clean. Provides excellent contact and a uniformly smooth tracking surface for improved operation from your mouse. 9³/₈ x 7⁷/₈". 26-237 4.95

Convenient Mouse Holder

Keep your mouse safe and within easy reach. Attach holder to the side of your monitor, CPU or desk and never search for your mouse again. 26-275 2.49

We have the accessories you need to keep your computer running smoothly and your desk organized

New! 3¹/₂" and 5¹/₄" Tandy Diskettes With Lifetime Warranty

Each disk is warranted against defects in workmanship and materials for the lifetime of the purchaser or we will replace it free. See store manager for details.



10 packs come in a protective plastic box.

Double-Certified 8" Diskettes

Sides	Density	Tracks	Capacity	Qty.	Cat. No.	Price
Single	Double	77	608KB	10	26-4906	37.95*
Double	Double	77	1.2MB	10	26-4960	39.95*

Double-Sided 3¹/₂" Disks

Density	Tracks	Capacity	Qty.	Cat. No.	Price
Double	80	720KB	3	26-432	3.49
			10	26-430	9.99
High	80	1.44MB	3	26-433	5.99
			10	26-431	16.99

Double-Sided 5¹/₄" Disks

Density	Tracks	Capacity	Qty.	Cat. No.	Price
Double	40	360KB	3	26-452	2.49
			10	26-450	6.99
High	80	1.2MB	3	26-453	3.99
			10	26-451	10.99

3¹/₂" and 5¹/₄" disks are preformatted.



Storage Boxes to Protect Your Valuable Diskettes

- (1) Library 3¹/₂". Holds 5. 26-1380 2/2.95
 Library 5¹/₄". Holds 5. 26-1348 2.95
 (2) Storage 3¹/₂". Holds 35. 26-140 11.95
 Storage 5¹/₄". Holds 50. 26-141 13.95

- (3) Economy Tote Boxes.
 3¹/₂". Holds 3. 26-213 1.09
 3¹/₂". Holds 10. 26-273 1.29
 5¹/₄". Holds 3. 26-216 1.19
 5¹/₄". Holds 10. 26-274 1.39



Disk Drive Cleaning Kit

Contains 3¹/₂" and 5¹/₄" diskettes and one ounce of cleaning fluid—enough for 15 cleanings each. Loads like an ordinary diskette to safely remove harmful data-destroying oxide buildup from single and double-sided drives. Takes only seconds. 26-295 7.95



Computer Care System

Everything you need! Contains the 15-application Disk Drive Cleaning Kit (26-295, at left), plus one four-ounce, pump-spray bottle each of video display cleaner, case and cabinet cleaner and anti-static solution. Includes 25 lint-free cleaning wipes. 26-296 19.95



Protective Dust Covers

- Universal System Cover.** Large tailored cover protects your CPU, monitor and keyboard. 26-541 9.95
Universal Color Monitor Cover. Keeps your monitor screen free of irritating dust and smudges. 26-548 6.95
Printer Dust Cover. For Tandy DMP 130/132/133/134/135/137/204 printers. 26-549, 6.95*
Printer Dust Cover. For Tandy DMP 136/202/203/240 printers. 26-550 6.95*

Keep your computer work area clean and organized with our system space-savers



(1) Deluxe Workstation. 29 $\frac{1}{2}$ " x 60 $\frac{1}{8}$ " x 27 $\frac{1}{4}$ " Desk (26-144, \$249.95) and 24 $\frac{7}{8}$ " x 60 $\frac{1}{8}$ " x 11 $\frac{5}{8}$ " Hutch (26-145, \$109.95). Plenty of work and storage space. Handy right side "drawer pedestal" rolls out and holds standard 80-column printer. Regular Separate Items \$359.90. **Save \$19.95. System Price 339.95***

(2) Mobile Work Center. Easily moved about home, dorm or office. No more set-up and tear down of computer system. Four shelves for computer and monitor, keyboard and printer paper. Rolls on four casters. Compact, it's only 30 $\frac{1}{4}$ " x 22" x 15 $\frac{7}{8}$ ". With illustrated instructions. **26-118 69.95**

(3) Workcenter Desk. Easy-to-assemble desk for your complete computer system. Pull-out drawer. Keyboard shelf slides under desktop. 28 $\frac{1}{4}$ " x 43 $\frac{3}{8}$ " x 23 $\frac{5}{8}$ ". **26-150 99.95**

(4) Printer Stand. Shelf for paper. 26 $\frac{3}{4}$ " x 21 $\frac{1}{2}$ " x 18 $\frac{1}{2}$ ". **26-242 49.95**
Items 1-4 require assembly



Universal Computer Stand. Two-piece floor stand saves valuable work space. Padded supports adjust from 3 $\frac{5}{8}$ " to 6 $\frac{7}{8}$ " to hold most CPUs safely upright underneath or beside your workstation. **26-119 ... 14.95**



Cable Security System. This low-cost theft deterrent features three mounting plates which attach to monitor, CPU and wall or desk. Comes with cable and combination lock. **26-1376 24.95***



Enhanced Keyboard. Get easier, more versatile data entry. 101-key AT-style keyboard. Features separate numeric and cursor key pads and 12 function keys across the top. Separate inverted "T" cursor keys. Separate caps lock, num lock and scroll lock LED indicators. 5-pin DIN connector. **25-4032 99.95***



Keyboard Cover. Protect your investment! Covers keyboard when it is not in use. Protects from harmful spills and damaging dust. Made of durable, see-through styrene. Fits Tandy and IBM® 101-key keyboards. (Not for low-profile keyboard). **26-1336 8.39**



Keyboard Protector. Stays in place while you type. Long-lasting, flexible. Causes no interference between keys. **26-123 (25-4032 style above) 19.95**
NEW! Low-Profile Keyboard Protector. **26-327 (2500 SX style) 19.95**

Portable Copy Stand

NEW! Stand is positioned at best angle for easy reading while keyboarding. Storage for two 3 $\frac{1}{2}$ " disks. Ideal for laptop users. **26-331 9.95**

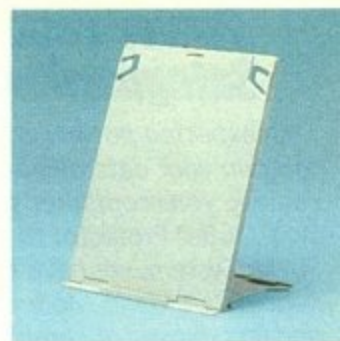

Computer Touch & Turn

NEW! A heavy-duty turntable for computer and monitor. Turn with only one finger. For TVs also. **26-460 19.95**

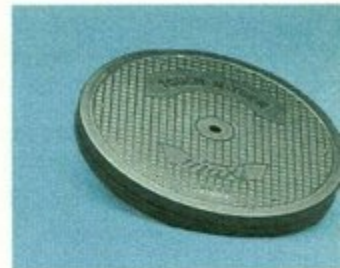

Monitor Top File Tray

NEW! Organize your work area with this file tray that stays out of the way. Mounts on top of monitor. **26-330 12.95**



Hinged Copy Holder

Holds copy at eye level using friction-grip rollers. Mounts to either side of any monitor. Swings back when not in use. **26-124, 6.95**



Keyboard Wrist Rest

NEW! Three angles to help reduce typing fatigue. May relieve symptoms of Carpal Tunnel Syndrome. **26-329 12.95**



Keyboard Flipstand

Saves on desk space! This unique keyboard stand lets you store your keyboard on its top edge when not in use. **26-1335 .. 6.95**



Adapter

Lets you easily connect the 25-4032 enhanced keyboard to mini-DIN CPU. (CMC) **26-142 4.95***



Keyboard Cable

6' shielded extension cable for use with keyboard or mouse. Mini-DIN plugs. **26-149 8.95**



Power conditioning: Safeguarding your PC

Unexpected power problems (see below) can ruin your data files and even seriously damage your computer system. From our Two-Outlet Protector to our Uninterruptible Power System, we have the solution. The benefits are clear: More computer "up-time" and less danger of computer damage.

F.Y.I.

SPIKES. High-voltage, short-duration overvoltages on AC power lines.

SURGES. Overvoltages of longer duration.

NOISE. High-frequency impulses that can create erratic operation in your computer.

SAGS. Undervoltage conditions lasting more than 1/60 of a second.

BROWNOUTS. Long-term undervoltage conditions, lasting minutes or even hours.

BLACKOUTS. Zero-voltage conditions, which can last for days.

ONE-WAY PROTECTION. Operates between the hot and neutral lines of AC power outlets.

THREE-WAY PROTECTION. Operates between the hot/neutral/ground lines of AC power outlets.

When quality is a top priority, we have the right connections to get the job done

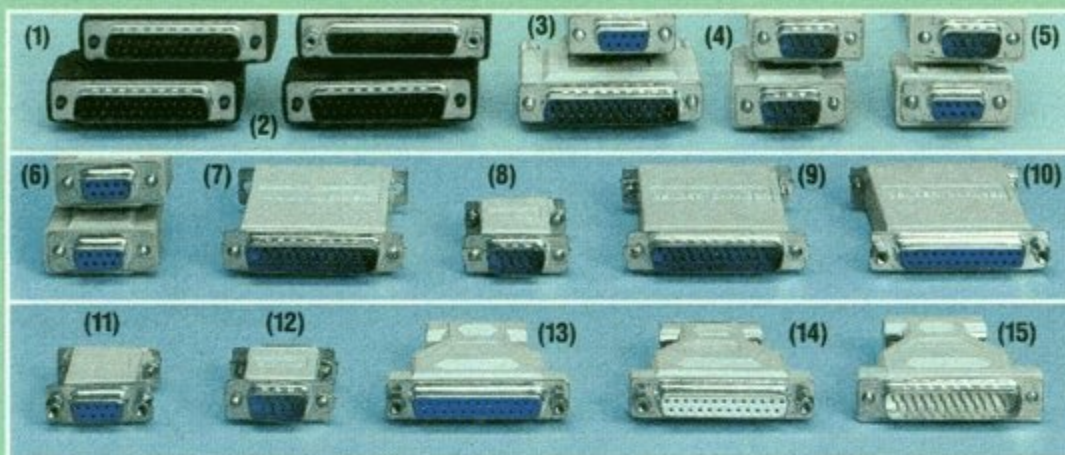

Our Serial RS-232C Cables and Connectors Keep You Computing

Fig.	Description	Connectors	Cat. No.	Each
1	6' round shielded	DB25 male/DB25 male	26-249	16.95
1	10' round shielded	DB25 male/DB25 male	26-291	24.95*
1	25' round shielded	DB25 male/DB25 male	26-292	32.95*
1	50' round shielded	DB25 male/DB25 male	26-293	48.95*
1	100' round shielded	DB25 male/DB25 male	26-294	69.95*
2	6' round shielded	DB25 male/DB25 female	26-240	16.95
3	6' round shielded	DB25 male/DB9 female	26-269	17.95
4	6' round shielded	DB9 male/DB9 male	26-116	9.95
5	6' round shielded	DB9 male/DB9 female	26-117	9.95
6	6' round shielded	DB9 female/DB9 female	26-152	9.95
7	Null Modem Adapter	DB25 male/DB25 female	26-1496	4.95
8	Null Modem Adapter	DB9 male/DB9 female	26-264	3.95
9	Gender Changer	DB25 male/DB25 female	26-243	4.95
10	Gender Changer	DB25 female/DB52 female	26-1495	4.95
11	Gender Changer	DB9 female/DB9 female	26-266	3.95
12	Gender Changer	DB9 male/DB9 male	26-280	3.95
13	Port Adapter	DB25 female/DB9 female	26-265	4.59
14	Port Adapter	DB25 female/DB9 male	26-1388	4.59
15	Port Adapter	DB25 male/DB9 female	26-209	4.59

Many other hard-to-find cables, connectors and computer supplies are available by special order through our exclusive Consumer Mail Center (CMC). If the item you need is not in stock at one of our nearly 7000 participating stores or dealers, we will order it for you. There is no shipping or handling charge.

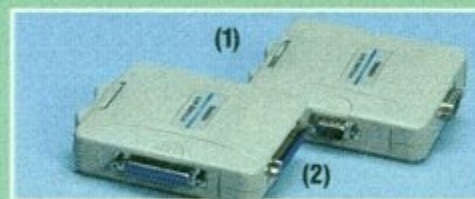

Shielded A/B Switches. Lets you select from two devices connected to one serial port.

(1) DB9 male/A or B DB9 male.
26-151 24.95*

(2) DB25 female/A or B DB25 female.
26-115 24.95*

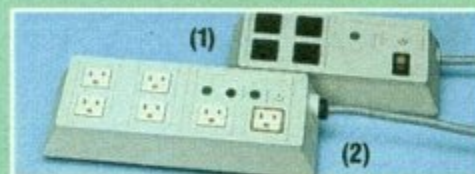

(1) 4-Outlet Power Center. With 3-way spike/surge protection and 1-way filtration.
26-1365 39.95

(2) 6-Outlet Power Center. Turns on peripherals automatically. 3-way protection/filtration.
26-1396 69.95

2-Outlet Protector (Not shown). 26-1395 .. 18.95

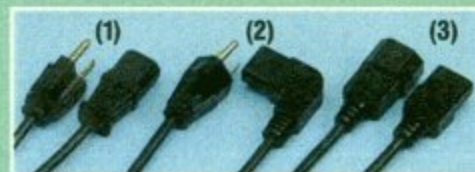

(1) 6-Ft. CEE Cord. 278-1257 3.99

(1) 12-Ft. CEE Cord. 278-1261 5.99

(1) NEW! 6 Ft. Shielded. 278-1262 4.99

(2) 6-Ft. Cord With Right Angle CEE Connector. Great for tight spaces. 278-1260 5.99

(3) 6-Ft. CEE Extension. 278-1259 4.99



6-Ft. Safety Cord Cover. Cover your PC system power cords so they don't become safety hazards. Vinyl strip provides safe walk area. AC power cord not included. Attractive neutral beige color.
26-1279 13.95*

High-Performance Off-Line UPS

UPS-300 Off-Line Uninterruptible Power System. Protects your computer and peripherals by providing power via an internal maintenance-free battery during blackouts and brownouts, giving you time to save your work and shut down your system. Protects against spikes, surges and sags, too. Three outlets, 250 watts. UL listed. (TSP) 26-251 .. 329.95*



Power Switching System

A "must" for protection and convenience. This popular device provides 3-way spike/surge protection and filtration. Also allows you to turn five individual accessories on and off from the front panel. Rated 15A. (TSP) 26-203 99.95

Transform your computer system into Information Headquarters with a fax modem and software



NEW! Internal V.32bis 9600-bps Data Modem With FAX and Hardware Data Compression. Awesome power in a modem! Data compression feature gives you up to 38,400 bps performance (when communicating with other V.42bis-equipped modems.) MNP and V.42 error correction. You can also send or receive faxes through your computer at 9600 bps. Class 2 fax communicates with all Group 3 fax machines. Includes FAX software. For all Tandy or other PC XT/AT compatibles with standard 8-bit expansion slot. **25-3029** **349.95**

NEW! External V.32bis 9600-bps Data Modem With FAX and Hardware Data Compression. Same power and features as above. Requires serial cable (not included). **26-3030** **399.95**

Internal 2400-bps Data Modem With FAX. Send at 9600 bps or receive faxes at 4800 bps through your computer. V.42bis and MNP 2-5 data compression software give you up to 9600 bps data performance (when communicating with other V.42bis-equipped modems). For all Tandy or other PC XT/AT compatibles with standard 8-bit expansion slot. Includes FAX software. **25-3027** **109.95**

External 2400-bps Data Modem With FAX and Hardware Data Compression. Send or receive faxes through your computer at 9600 bps. V.42bis and MNP 2-5 data compression (built in) give you up to 9600 bps data performance (when communicating with other V.42bis-equipped modems). Requires serial cable (not included). **25-3028** **199.95**

Radio Shack Has the Modem or Fax Modem You Need

Modem Type	300 bps	1200 bps	2400 bps	9600 bps	Send/Receive FAX Type	MNP 2-5 Error Correction	Cat. No.	Each
Internal	X	X	X			Software	25-3025	79.95
External	X	X	X			Software	25-3026	99.95
Internal	X	X	X		Class 1	Software	25-3027	109.95
External	X	X	X		Class 2	Hardware	25-3028	199.95
Internal	X	X	X	X	Class 2	Hardware	25-3029	349.95
External	X	X	X	X	Class 2	Hardware	25-3030	399.95

Communicate With Other PCs Around the World

To maximize the use of your computer system, use an online computer service (like those described on this page). These services maintain huge banks of information, accessible to PC users over phone lines. All you need is a telephone modem for your PC and a subscription to your choice of several online services.

Online services are a "must" for anybody who needs the latest financial reports and market conditions, the latest news, quick reference materials, electronic mail—any data that can be transmitted over the telephone. Online services are easy to access and to use—you don't have to be a computer veteran to enjoy all the benefits—it's as easy as a phone call.

America Online. An easy-to-use graphical online service that brings your computer to life. Services available include News and Finance, People Connection, Lifestyles & Interests, Games & Entertainment, Travel & Shopping and more. America Online also features an online encyclopedia that's great for helping youngsters with reports and homework. Includes support from Tandy computer experts. Software shipped with Tandy computers.

PRODIGY Start-Up kit. Get online with the latest news, weather and sports, plus shopping, entertainment, financial services and electronic mail—it's all yours on the PRODIGY interactive personal service. Your membership lets up to six people in your household explore a constantly growing selection of useful information and helpful services. What are you waiting for? **26-1256** **49.95**

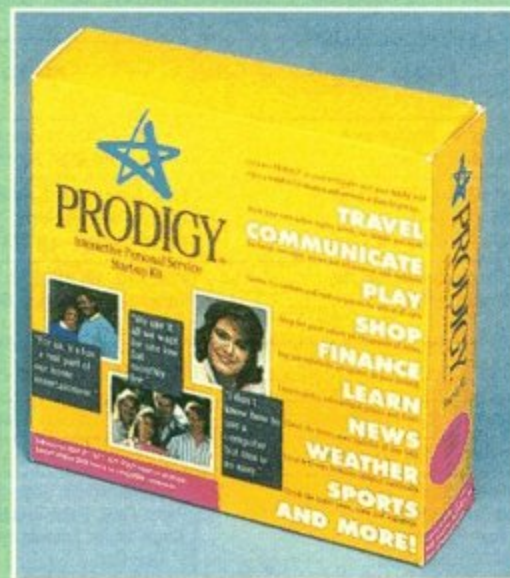

What can a modem do for you?

Modems are devices that allow your computer to communicate over standard telephone lines with other computers, anywhere in the world.

Information services you can access with a modem provide online, stock market prices, encyclopedias, sports scores, movie reviews, health and fitness services, games and much more.

We offer superior modems that make it easy for you to download your work directly to your personal computer—even if you're miles away. And our commitment to quality doesn't stop there. Our modems are FCC registered and backed with the best support and service in the industry.

We also offer FAX modems that allow you to turn your computer into a fax machine. You can actually send or receive faxes right from your PC!

With Tandy modems, you get a full Hayes® command set, auto-answer/dial, four com ports and four interrupts, manual, communications software and telephone cord. UL and Class B certified. Quality-built in the USA.

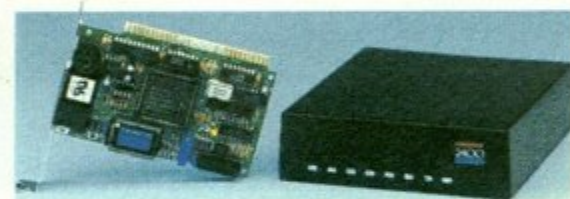

Internal 2400-bps Modem. Data compression software gives you up to 9600-bps performance (when communicating with other V.42bis equipped modems). For all Tandy or other PC XT/AT compatibles. **25-3025** **79.95**

External 2400-bps Modem. Same as above, but requires serial cable (not included). **25-3026** **99.95**

F.Y.I.

DATA COMPRESSION. Compresses data to send over phone lines at a greater rate. The highest compression is V.42 bis, which compresses at a 4:1 ratio.

BPS (bits per second). The data transfer rate. The higher the number, the faster the modem. With V.42 bis compression, a 9600-bps modem can transfer data at up to 38,400 bps.

ERROR CORRECTION. Software that detects and corrects errors in transmitted information. MNP and V.42 are examples of error correction software.

Next to your PC, nothing beats a Tandy Printer



(1) DMP 2104. The ideal printer for personal as well as business use. Convenient front-panel controls—no dip switches to set! Quietly prints up to 240 characters per second. With 360 × 180 graphics, correspondence mode, push tractor, paper park and semi-automatic paper feed. (TSP)

26-2865 499.95*

(2) DMP 302. For home or office correspondence. Prints up to 270 characters per second, as well as 360 × 180 dpi graphics. Push tractor lets you print on continuous fanfold paper without waste. Comes with semi-automatic single-sheet feed, paper park, 16K memory and six resident fonts. Was \$599 in 1992 Catalog. (TSP)

26-2849 New Low Price! 499.95*

Sheet Feeder. (TSP) 26-2816 299.95*

(3) DMP 2130. Our finest, ultra-fast dot-matrix printer makes sense for your business needs. Features a 28-pin design that prints up to 480 characters per second. Flat bed prints 6-part forms up to 16½" wide. Paper Park lets you print a single cut sheet without removing your fanfold paper—the ultimate in printing convenience. Push tractor with 1" tear. Was \$1199.00 in 1992 Catalog. (TSP)

26-2845 New Low Price! 899.00*

(4) NEW! DMP 310 Slimline. A truly portable printer! With 24-pin print head (optional battery box for portable operation available, below). Prints 180 cps on single sheets. IBM Proprinter X24 emulation. (TSP)

26-2876 399.95*

Internal Battery Box. (Batteries not included.) 26-2877 59.95*

Key Features	DMP 2104	DMP 302	DMP 2130	DMP 310
Printing Technology	24-pin dot matrix, impact-type, bidirectional logic seeking	24-pin dot matrix, impact-type, bidirectional logic seeking	28-pin dot matrix, impact-type, bidirectional logic seeking	24-pin dot matrix, impact-type, bidirectional logic seeking
Printing Speed	High-Speed Utility—200 cps Draft Utility—240 cps Draft Letter-Quality—66 cps	High-Speed Utility—270 cps Draft Utility—225 cps Draft Letter-Quality—75 cps (10 cpi)	High-Speed Utility—480 cps Draft Utility—400 cps Draft (10 cpi) Letter-Quality—66 cps (12 cpi)	Draft—180 cps NLQ—50 cps (10 cpi) Letter-Quality—60 cps (12 cpi)
Fonts	Gothic Draft—10, 12, 15, 17.1 LQ Courier—10, Elite—12	Roman, Helvette, Orator, Gothic, Prestige, Courier, Draft	Pitch: 10, 12, 15, 17.1, 20. Letter-Quality—Sans Serif Letter-Quality, Draft	Pitch: 10, 12, 15, 17.1 Letter Quality—Roman, Sans Serif
Graphics Resolution	360 × 180 dpi	360 × 180 dpi	240 × 216 dpi	360 × 180 dpi
Emulations	IBM Proprinter X24, Epson LQ-1050,	IBM Proprinter X24, Epson LQ-850	IBM Proprinter XL, Epson FX286e	IBM Proprinter X24
Input Buffers	32K	16K user memory, 32K download	32K	1K
Paper Handling	Semi-Automatic Sheet Feeder One-Button Fanfold Paper Park One-Inch Tear Push Tractor Single-Sheet Friction Feed	Semi-Automatic Sheet Feeder One-Button Fanfold Paper Park One-Inch Tear Push Tractor Single-Sheet Friction Feed	Semi-Automatic Sheet Feeder Paper Park, Push Tractor Feed Single-Sheet Friction Feed 1" Tear Bar	Single-Sheet Feed Only
Ribbon	26-2869 Black, \$16.95	26-2819 Black, \$11.95	26-2846 Black, \$34.95	26-2878 Black, \$14.95

Create a lasting impression of quality



(1) **NEW! DMP 203.** Prints up to 192 characters per second and contains four resident fonts. With 24-pin print head. (TSP) 26-2880 299.95
 (2) **NEW! DMP 204.** 24-pin print head is color ready. Prints 192 characters per second in four resident fonts. With push tractor feed, semi-automatic paper loader and 43K print buffer. (TSP) 26-2883 (Available Sept. 30, 1992) 349.95
Color Ribbon for DMP 204. 26-2900 29.95
 (3) **NEW! JP 250 Jet Printer.** Get the perfect print of a laser printer on a compact, portable ink jet printer. Prints 360 dpi graphics and up to 100 characters per second. Includes IBM® Proprinter X24E and Epson LQ 850 emulations. (TSP) 26-2873 349.95*
Sheet Feeder. 26-2884, 89.95. Rechargeable Battery. 26-2885 49.95*

(4) **DMP 240.** Add a more creative dimension to your work by creating colorful charts, graphs and other visual displays (color ribbon sold separately, below). Great for business presentations, as well as school and other personal work that can benefit from color enhancement. Prints up to 160 cps in four fonts. With 24-pin print head. (TSP) 26-2839 399.95*
Color Ribbon. 26-2826 29.95
 (5) **DMP 136.** This 9-pin dot-matrix printer is the perfect choice for word processing, general use and graphics which require high-resolution printing, including color printing (color ribbon sold separately, below). Prints original, plus up to three copies. (TSP) 26-2868 249.95
Color Ribbon Cartridge. 26-2826 29.95

Key Features	DMP 203	DMP 204	JP 250	DMP 240	DMP 136
Printing Technology	24-pin dot matrix, impact-type, bidirectional logic seeking	24-pin dot matrix, impact-type, bidirectional logic seeking, color ready	Serial jet ink on-demand 64 nozzles, disposable cartridge	24-pin dot matrix, impact-type, bidirectional logic seeking, color ready	9-pin dot matrix, impact type bidirectional logic seeking, color ready
Printing Speed	High-Speed Draft—192 cps Draft—160 cps (10 cpi)	High-Speed Draft—192 cps (12 cpi) Draft—160 cps (10 cpi) Letter-Quality—64 cps (12 cpi)	Up to 100 cps	High-Speed Utility—192 cps Draft Super High-Speed—213 cps (15 cpi)	Draft—160 cps (10 cpi) NLQ—40 cps (10 dpi) Super High-Speed—213 cps (15 cpi)
Fonts	Pitch: 10, 12, 15, 17.1	Pitch: 10, 12, 15, 17.1	Pitch: 10, 12, 15, 17, 20. PS Letter Quality—Roman, Sans Serif, Draft, Courier, Prestige Elite.	Pitch: 10, 12, 15, 17.1, 20 and Proportional Courier and Prestige	Pitch: 10, 12, 17.1, Proportional
Graphics Resolution	360 x 180 dpi	360 x 180 dpi	Horizontal 360 dpi	360 x 180 dpi	240 x 216 dpi
Emulations	IBM Proprinter X24	IBM Proprinter X24, Epson LQ-500/850 with color	IBM Proprinter X24E, Epson LQ-850	IBM Proprinter X24, Epson LQ 2500 color	IBM Proprinter III, Epson FX-850/JX-80
Input Buffers	12K	43K	20K (LQ Mode), 37K (Model 1/Model 2)	8K, upgradeable to 40K (26-2853)	8K
Paper Handling	Semi-Automatic Paper Loading Push Tractor Feed	Semi-Automatic Paper Loading Push Tractor Feed	Single-Sheet Feed Only Optional Automatic-Cut Sheet Feeder (26-2884)	Semi-Automatic Sheet Feeder, Paper Park, Single-Sheet Friction Feed 1 1/4" Tear Bar	Push Tractor and Friction Feed Semi-Automatic Single-Sheet Feed Paper Park Friction Feed, 1/4" Tear Bar
Ribbon	26-2871 Black, \$13.95	26-2871 Black, \$13.95 26-2900 Color, \$29.95	26-2874 Ink Cartridge, \$29.95	26-2826 Color, \$29.95 26-2824 Black, \$10.95	26-2826 Color, \$29.95 26-2824 Black, \$10.95

Printer supplies and accessories to make the best impression

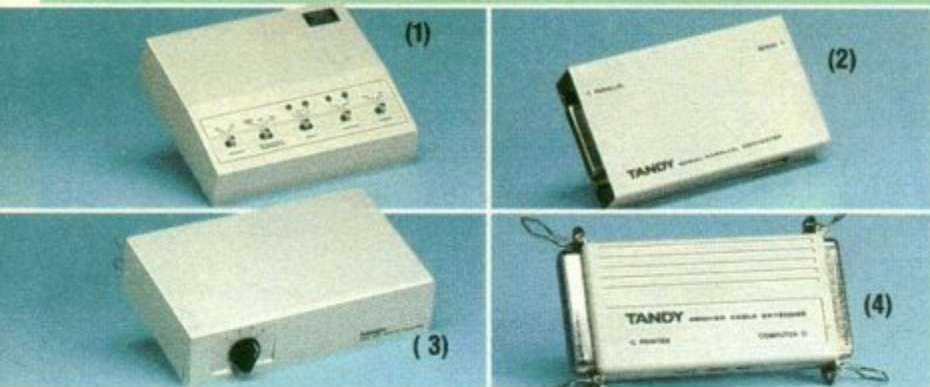

Accessories to Take Control of Your Printer

- (1) **Printer Selector Switch 3.** (TSP) 26-2844 99.95*
- (2) **Serial-to-Parallel Port Converter.** Converts standard RS-232 port to a parallel port. (TSP) 26-2829 99.95
- (3) **Four-Way Printer Switch.** Switches a single printer between four computers. 26-2828 59.95*
- (4) **Printer Cable Extender.** Requires #26-290 cable, below. 26-2840 29.95

We Have the Cable for Any Tandy Printer

Fits	Description	Length	Cat. No.	Each
Tandy 1000 Series (Except RL/RLX and TL/3)	Edge Card/36-pin Tandy port for most Tandy printers	6' S	26-225	24.95*
		12' S	25-222	32.95*
	Edge Card/36-pin IBM port	6' S	26-289	24.95*
		12' S	26-1259	32.95*
Tandy 1000 RL/RLX/TL3/3000/4000/5000/WP/2 IBM All Tandy Laptops	25-pin male/Tandy port for most Tandy printers	6' S	26-227	19.95
		12' S	26-223	24.95
	25-pin male/36-pin IBM port	6' S	26-288	19.95
		12' S	26-1258	24.95
		30' S	26-1284	9.99
Color Computer/MC-10 Model I/III/4/4P/4D	4-pin DIN/4-pin DIN Special Serial Cable	6'	26-3020	5.95*
Model II/12/16/16B/2000/6000	Edge Card/36-pin Tandy port	6'	26-1401	19.95*
Model 100/102/200/600	34-pin female header/36-pin Tandy port	6'	26-4401	19.95*
Extension Cable for 26-2840	26-pin female header/36-pin Tandy port	6'	26-1409	16.95*
	36-pin male/36-pin male, Requires 26-2840 30' S 26-290	25' S	26-290	59.95*

Note: An "S" after the cable length indicates shielded round cable.

90° Angle Adapters

Quick, convenient adapters—simply plug into any printer cable and printer that uses a Centronics connection.

- Right Angle Adapter. 26-2867 10.95
- Left Angle Adapter. 26-2870 ... 10.95

Mailing and Fanfold Labels

Mailing Labels. Self adhesive, 4 x 3". Pkg. of 335.

- Red & Yellow. 26-126 8.95
- Blue Border. 26-127 8.95

Width	Carrier	Qty.	Cat. No.	Each
1	4 1/4"	1000	25-1328	6.29
1	4 1/4"	5000	26-261	19.95*
2	9 1/2"	2000	26-262	16.95*
4	9 1/2"	3000	26-263	16.95*

Keep Plenty of Roll Paper Handy

Type	Size	Rolls/Pkg.	Cat. No.	Price	Type	Size	Rolls/Pkg.	Cat. No.	Price
Thermal Electrostatic	4 1/4" x 80'	2	26-1332	5.49*	Paper Thermal	4 1/2" x 150'	3	26-1428	6.49*
	2 1/2" x 75'	2	26-1412	11.95*		2 1/4" x 57"	5	26-3592	2.49*

Stock Up Now on Fanfold Paper

Letter	9 1/2" x 11"	White	1000	20#	80	Micro-invisible	26-134	11.99
Letter	9 1/2" x 11"	White	2500	20#	80	Micro-invisible	26-135	27.99*
Other	14 7/8" x 11"	Bluebar	1000	15#	72	None	26-136	16.99*

Replacement Printer Ribbons

Printer	Ribbon	Cat. No.	Each
LP I, II, IV	Fabric Pack (3/PK)	26-1413	19.95*
LP III, V	Fabric Cart.	26-1414	9.95*
LP VI/VIII, DMP 400/420	Fabric Cart.	26-1418	9.95*
LP VII, DMP 100	Re-inking Fabric	26-1424	13.95*
DMP 110	Re-inking Fabric	26-1283	8.95*
DMP 130/130A/132/133/107/134/135	Black Ribbon	26-1236	10.95
DMP 130/130A/132/133/107/134/135	Refill (3/PK)	26-1238	14.95
DMP 130/130A/132/133/107/134/135	Color Ribbon Pack	26-1235	19.95
DMP 500	Fabric Cart.	26-1482	13.95*
DMP 120, 200	Fabric Cart.	26-1483	11.95*
DMP 105, 106	Black Fabric Cart.	26-1288	8.95
DMP 240, 136	Black Fabric	26-2824	10.95
DMP 240, 136	4 Color	26-2826	29.95
DMP 202/203/204	Black Fabric	26-2871	13.95
DMP 204	4 Color	26-2900	29.95
JP 250	Black Inkjet	26-2874	29.95
DMP 310	Black Fabric	26-2878	14.95
DMP 430	Black Fabric Cart.	26-1296	14.95
DMP 440	Fabric Cart.	26-2809	34.95
DMP 2100, 2100P, 2110	Fabric Cart.	26-1442	9.95*
DMP 2120	Black Ribbon	26-2834	39.95*
DMP 2120	Black Refill	26-2836	18.95*
DMP 2130	Black Fabric	26-2846	34.95*
LMP 2150	Black Cartridge	26-1287	17.95*
TRP 100	Black Thermal Film	26-1297	7.95*
DMP 2104	Black Fabric	26-2869	16.95*
DW II, DWP 410, 510	Multi-Strike (3/PK)	26-1419	19.95
DW II, DWP 410, 510	Nylon Cart.	26-1449	7.95*
DWP 520, 230, 210	Multi-Strike (3/PK)	26-1445	19.95
DWP 520, 230, 210	Fabric Cart.	26-1458	7.95*
DWP 220	Black Multi-Strike	26-1299	24.95*
DMP 300/2102/302/2103	Black Ribbon	26-2819	11.95
DMP 442	Black Ribbon	26-2823	11.95
DMP 2200	Black Ribbon	26-2825	22.95*
DMP 440	Refill	26-2827	19.95*
PC-2 Plotter/CGP 115	Black	26-1480	2.95
PC-2 Plotter/CGP 115	Color	26-1481	2.95
WP-100/101	Black Single-Strike	26-3952	9.95
WP-100/101	Lift-Off Correction	26-3953	3.95
WP-100	Black Multi-Strike	26-3954	11.95*
WP-100	Cover-Up Correction	26-3955	6.95*



Create Iron-Ons!

Print 'n Press™. Make a design on your computer, place a transfer sheet in the printer, print it, then iron-on the design. Includes five blank iron-ons. 26-1437 9.99



Printer Supports

Stores fanfold paper under your 80-column printer. Easy to assemble. 26-236 8.95

Acoustic Cover. (Not shown.) 26-235 9.99



Stand With Tray

Use with your 80 or 132-column printer. Easy to assemble. Includes paper catcher. 26-1392 14.95

Multi-Form Feeder. (Not shown.) 26-268 .. 24.95

Printwheels Add Style to Your Work! Only \$16.95 Each*

Font	Catalog No.	Font	Catalog No.
Courier 10	26-3956	Courier 12	26-3957
Pica 10	26-3958	Script 12	26-3960
Letter/Gothic 10/12	26-3959	Prestige Elite 12	26-3961

We Can Help With Hard-to-Find Printer Supplies

Print wheels, plotter pens and roll paper for all Tandy and Radio Shack daisy wheel printers and plotters, plus copier supplies, are available by special order through our exclusive Consumer Mail service. If the items you need are not currently in stock, we will order them for you at no extra charge.

Get professional results with high-speed laser printers



New! Entry-Level LP 400

Printing at four pages per minute, the LP 400 comes with HP PCL4 LaserJet IIP emulation for fantastic results. Front-panel controls make it easy to use. It's lightweight—only 28.7 lbs., plus its small size (14.3 x 15.9 x 7.7") takes up less space on a desktop. Comes with a standard HP-type font cartridge slot and 512K RAM, expandable to 2.5MB. 300dpi resolution, with 14 resident fonts (Bitmap). Includes RS232/RS422A and parallel interfaces. Low-noise standby mode and Quiet Print technology. FCC Class B, UL listed. (TSP) **26-2888 899.00***

New! The Powerful, Versatile LP 410

Has the same great features as the LP 400 above, except it comes with HP PCL5 LaserJet III emulation, plus Epson FX-850 and IBM ProPrinter X24e emulation. Add the optional Pagestyler™ PDL Cartridge for Postscript™ for instant emulation of industry-standard Postscript. Comes with 1MB of memory, expandable to 3MB. Resident 14 Bitmap fonts, plus eight scalable fonts. Unique EET® (Edge Enhancement Technology) mode gives greater printer resolution, eliminates jagged edges and smooths printing for picture-perfect printing. FCC Class B, UL listed. (TSP)

26-2889 1099.00*

New! Top-of-the-Line LP 800

Get eight pages of beautiful, crystal-clear printing per minute! The LP 800 features the same versatile emulations and fonts as the LP 410 above, plus the EET mode, which provides an effective resolution of 600 dots per inch to create near-typeset-quality text and crisp, clean graphics. Two standard HP Font Cartridge slots. Comes with 1MB of RAM, expandable to 5MB. Weighs 32 lbs. 15.5 x 15.9 x 8.6". FCC Class B, UL listed. (TSP)

26-2890 1499.00*

Keep Looking Good With Laser Printer Accessories

Replacement Toner Cartridge. 26-2894	... 23.95*
Drum Kit. 26-2895 119.95*
LP 400/410 Developer. 26-2897 159.95*
LP 800 Developer. 26-2898 159.95*
1MB Memory Kit. For LP 400/410/800. 26-2892 199.95*
2MB Memory Kit. For LP 800. 26-2893 399.95*
Pagestyler™ PDL Cartridge Postscript Emulation. Requires 3MB memory in printer. For LP 410/800. 26-2891 399.95*
2nd Bin Sheet Feeder for LP 400/410. Letter-size only. 26-2901 249.95*
2nd Bin Sheet Feeder for LP 800. Letter/legal-size paper. 26-2902 249.95*

Tandy LP 1000 Accessories

LP 1000 Toner. 26-2807 27.95*
LP 1000 Kit A. 26-2805 199.95*
LP 1000 Kit B. 26-2806 99.95*

Tandy LP 950/990 Accessories

Sheet Feeder. Requires 26-2860 or 26-2863. 26-2861 CMC 259.95**
Envelope Feeder. 26-2862 CMC 259.95**
Letter Paper Cassette. 26-2863 CMC 59.95**
Legal Paper Cassette. 26-2860 CMC 59.95**
1.5MB Memory Upgrade. 26-2852 599.95*
Toner Cartridge. 26-2841 64.95*
Developer Cartridge. 26-2843 149.95*
Drum Cartridge. 26-2842 149.95*
Font Cards	
"B." 26-2854 CMC 139.95**
"F." 26-2855 CMC 199.95**
"L." 26-2857 CMC 199.95**
"M." 26-2856 CMC 199.95**
"N." 26-2858 CMC 199.95**
"P." 26-2859 CMC 199.95**

Our Commitment to Business is Unsurpassed

Radio Shack is your one-stop shop for quality consumer electronics and computers. But we can also configure a system tailored to your business needs. You get a complete solution, backed with the best in leasing and service plans. Instead of just selling you a piece of machinery, we design specific answers to your business' problems. We're dedicated to working with you, and we service what we sell. At Radio Shack, we don't just sell PCs, we sell solutions!



CDR-1000 Internal CD-ROM Drive. Get the superb audio, graphics and information handling of multimedia technology. Features a fast data-transfer rate of 150K bytes per second, super-easy loading, an audio-play program, MS-DOS 2.2, extensions and all necessary boards and drivers. (TSP) 25-1077 **399.95**



5 1/4" 60/120MB Tape Cartridge System. Quickly store your data for safety and convenience. (TSP) Was \$399.95 in '92 Catalog. 25-4079 **New Low Price! 299.95***

60MB Disk Cartridge. DC 2120 compatible. 26-246 **37.95***

Replacement Cartridges for Other Systems

40MB Cartridge. DC 2000 compatible. 26-218 ... **32.95***

150MB 1/4" Data Tape Cartridge. DC 6150 compatible. 26-204 **44.95***

20MB Bernoulli 5 1/4" Disk Cartridge. For 25-4064. 26-221 **119.95***

Memory Expansion Kits Open Your PC to a New World of Powerful Applications

NEW! 2MB Memory Kit. Contains two 1 x 9 70ns SIMMs. (TSP) 25-5137 **149.95***

NEW! 8MB Memory Kit. Contains two 4 x 9 70ns SIMMs. (TSP) 25-5136 **499.95***

OK Memory Board. For 4016 DX/4020 LX/4025 LX/4033 LX. (TSP) 25-6030 **109.95***

128K Memory Kit. Upgrades the Tandy 1000 TX and TL series from 640K to 768K RAM, the Tandy SL from 384K to 640K (requires two kits) and the SL/2 from 512K to 640K RAM. Contains four 64K x 4 DRAMs. Was \$39.95 in '92 Catalog. 25-1078 **New Low Price! 19.95***

256K Memory Kit. Expands Tandy 1000 SX from 384K to 640K. Contains eight 256K x 1 DRAMs. Was \$59.95 in '92 Catalog. 25-1079 **New Low Price! 39.95***

256K Memory Kit. Upgrades the Tandy 1000 RL from 512K to 768K RAM. Contains two 256 x 4 70ns DRAM chips. Also upgrades video memory from 512K to 1MB (requires 2 kits) for Tandy 4800 series desktops. Was \$59.95 in '92 Catalog. 25-1082 **New Low Price! 39.95***

512K Zip Memory Kit. Adds 512K RAM to the Tandy 1000 RLX. Contains four zip chips. (TSP) Was \$79.95 in '92 Catalog. 25-1083 **New Low Price! 59.95***

Tandy 1000 EX/HX Expansion Options

NEW! Memory PLUS Expansion Adapter. Adds 384K to your Tandy 1000 EX or HX. (TSP) 25-2062 **189.95***

External 3 1/2" 720K Floppy Disk Drive. (TSP) 25-1061 **99.95***

PLUS RS-232 Serial Interface. Connects serial devices like a mouse or modem. DB25F Connector. (TSP) AX25-1031 **59.95***

Supercharge your PC with Tandy hard drives, floppies, memory upgrades and more!



Store and access volumes of data with a fast Tandy hard drive

We've got what you want in hard drives—choose the size and speed to fit your needs and budget!

SmartDrive IDE 3 1/2" Hard Drives

40MB XT/AT 1" Height. (TSP) Was \$399.95 in '92 Catalog. 25-1048 **New Low Price! 299.95**

8-Bit SmartDrive Adapter. (TSP) 25-1088 **79.95**

NEW! 240MB AT 1" Height. (TSP) 25-4126 ... **699.00***

NEW! 120MB AT 1" Height. (TSP) 25-4127 ... **499.95***

NEW! 85MB AT 1" Height. (TSP) 25-4128 **399.95***

High-Performance SCSI Drives

40MB 3 1/2" SCSI Hard Drive. (TSP) 25-4159 **499.95***

16-Bit SCSI Host Adapter. (TSP) Was \$349.95 in '92 Catalog. 25-4161 **New Low Price! 299.95***

440MB Half-Height 5 1/4" SCSI Hard Drive. (TSP) Was \$2199.00 in '92 Catalog. 25-4167 **New Low Price! 1499.00***

Hard Drive/Adapter Selections

Hard Drive	1000 RL 1000 RLX	1000 TL/2 1000 TL/3	1000 1000 SX, TX 1000 SL, SL/2, TL	3000-Series 4000	2500-series 4000 SX 4016 SX 4020 SX 4800-series	4016 DX 4020 LX 4025 LX 4033 LX
SmartDrive IDE XT/AT Hard Drive: 40MB, 28ms. 25-1048	No adapter required	No adapter required	Requires 25-1088 Interface	Requires 25-1088 Interface	N/A	
SmartDrive IDE AT Hard Drives: 85MB, 18ms. 25-4128 120MB, 15ms. 25-4127 240MB, 16ms. 25-4126	N/A	N/A	N/A	Requires 16-Bit IDE Interface Adapter	No adapter required	
SCSI Hard Drives: 40MB, 19ms. 25-4159* †440MB, 16ms. 25-4167*	N/A	N/A	N/A	Requires SCSI Host Adapter 25-4161	Requires SCSI Host Adapter 25-4161 †(Not recommended for 2500-series)	

*Drive mounts in 5 1/4" device slot in Tandy's Low-Profile Chassis.

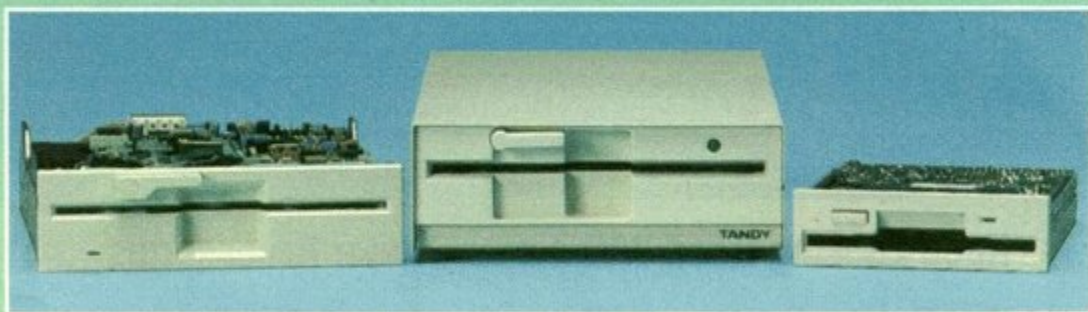

Boost productivity with a 3 1/2" or 5 1/4" floppy drive

5 1/4" 1.2MB Internal Floppy Drive. (TSP) Was \$159.95 in '92 Catalog. 25-4050 **New Low Price! 119.95***

5 1/4" 360K Internal Floppy Drive. (TSP) Was \$139.95 in '92 Catalog. 25-4051 **New Low Price! 109.95***

5 1/4" 1.2MB External Floppy Drive. Connects through 25-pin parallel port with pass through for printer cable. (TSP) 25-1087 **299.95**

3 1/2" 1.44MB Internal Floppy Drive. (TSP) Was \$139.95 in '92 Catalog. 25-4053 **New Low Price! 99.95***

3 1/2" to 5 1/4" Adapter Bracket. Allows you to install a 3 1/2" floppy (25-4053, above) in a 5 1/4" device slot. 25-1076 **34.95***

Drive Format	Computer						
	1000 RL Floppy Drive Only	1000 TL/3 1000 RLX Floppy Drive Only	1000 RLX HD 1000 RL HD And Laptops Computers	3000 4000 4000 LX	2500 SX 2500 XL 3000 NL 4000 SX 4016 SX	4020 SX 4016 DX 4020 LX 4025 LX 4033 LX 5000 MC	2500 SX/25 4800-series
5 1/4" 360K	N/A	N/A	N/A	Internal 25-4051	Internal 25-4051		Internal 25-4051
5 1/4" 1.2MB	External 25-1067	External 25-1087	External 25-1087	Internal 25-4050	Internal or External 25-4050	External 25-1087	Internal 25-4050
3 1/2" 1.44MB	N/A	Internal 25-4053	N/A	25-4053 (Requires 25-1076)	Internal 25-4053		25-4053 (Requires 25-1076)

Choose from Tandy's wide choice of PC monitors—we've got the one to suit your needs

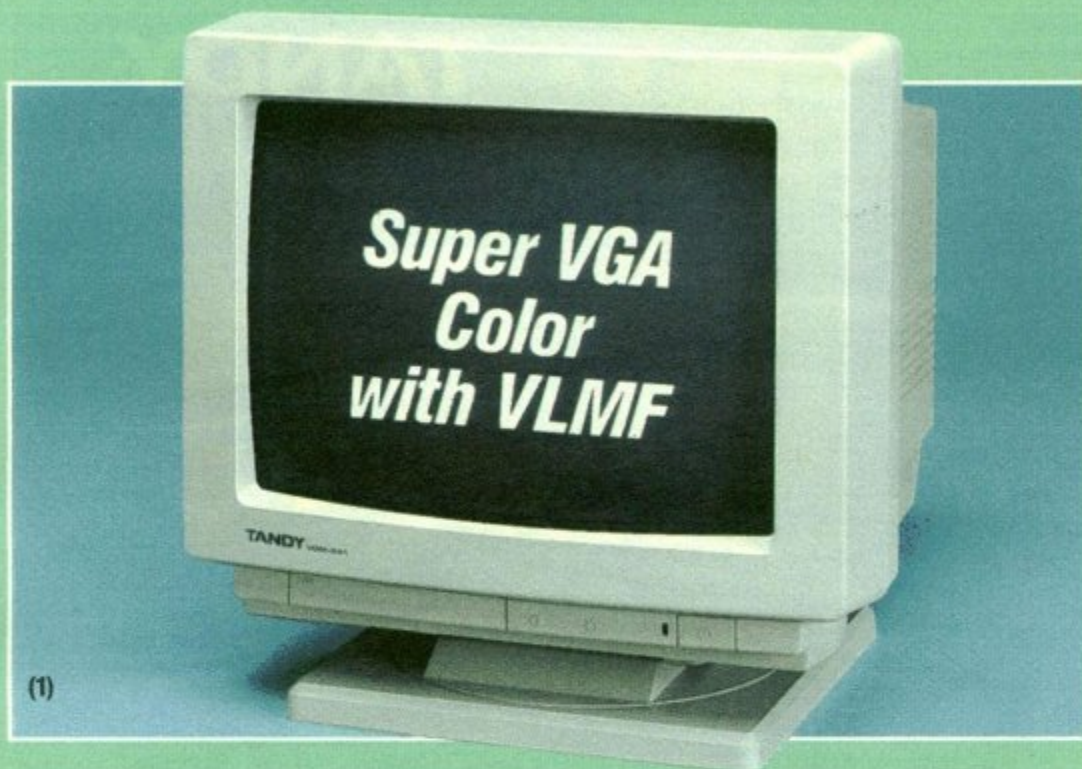

(1)

Our Super VGA monitors' antistatic screens eliminate dust attraction and static shock. All controls are up front, and a six-foot connecting cable makes hook-up easy.

(1) NEW! VGM-441 Super VGA Color Monitor. Supports high-resolution mode of 1024 x 768 with unlimited colors. 14" display with .28mm dot pitch. With tilt-swivel base. (TSP) 25-4048 499.95*

NEW! 16-Bit SVGA Graphics Adapter with 512K RAM. Works great in either 8 or 16-bit slot. Upgrade today! (TSP) 25-4056 . . 119.95

(2) NEW! VGM-340 Super VGA Color Monitor. Here's your low-cost entry port into the stunning world of Super VGA graphics. The exciting new VGM-340 supports high-resolution mode of 1024 x 768 with unlimited colors. Its 14" display delivers a .39mm dot pitch. Comes with tilt-swivel base to easily select the most comfortable viewing angle. (TSP) 25-4047 399.95

(3) VGM-220 VGA Color Monitor. Get VGA quality at an affordable price. The VGM 220's 14" display delivers super-clear 640 x 480 graphics resolution in .52mm dot pitch. This low-cost VGA monitor delivers brilliant, vivid colors with a remarkable clarity. Perfect for graphics design and desktop publishing. (TSP) Was \$399.95 in '92 Catalog. 25-4044 **New Low Price! 299.95**

(4) NEW! VGM-150 Full-Page Monochrome VGA Monitor. No special graphics adapter required. Paper-white display and crisp, full-page text gives you a full view just like a piece of paper. 15" display. With tilt-swivel base. (TSP) 25-4090 299.95*

VGM-100 Monochrome VGA Monitor. (Not shown.) 14" display. (TSP) 25-4040 199.95*



(2)



(3)



(4)

F.Y.I.

Monochrome monitors are your most economical choice—great for text-based applications and basic spreadsheets. **CGA** monitors give clear color for business charts and arcade-like games. **VGA** color monitors are ideal for engineers or anyone who needs crisp graphics. **Super VGA (SVGA)** offers even higher resolution modes. Tandy's new SVGA monitors have extra shielding for reduced emissions at **Very-Low-Magnetic Frequency (VLMF)** and **Extremely Low Frequency (ELF)**, assuring compliance with the strict ergonomics and emissions guidelines ("MPR II") set by the Swedish National Council for Metrology and Testing.



CM-11 High-Resolution CGA Color Monitor. 13" screen displays 80 x 25 text, 640 x 200 graphics resolution. (TSP) 25-1024 399.95

VM-5 Monochrome Monitor. (Not shown.) 12" screen displays 80 x 25 text, 720 x 350 graphics resolution. (TSP) 25-3012 149.95

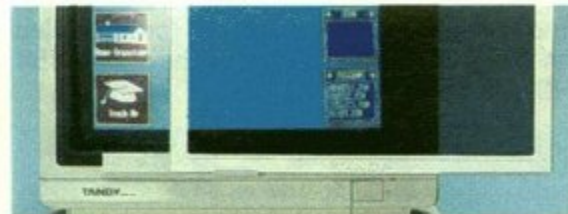

Anti-Glare Filter. Reduce eyestrain with this durable, optically coated glass filter that cuts glare by 95%. Controls reflections and "washout" from bright lights. 26-279, 39.95



Universal Monitor Pedestal. Adjustable for better viewing. Base measures 11 x 10". 26-1369 16.95

Every Tandy PC is built on a solid 15-year tradition of quality

First One. Radio Shack started the PC revolution with the introduction of the first mass-marketed personal computer in 1977. Our experience helps us serve you better—nobody has been in the PC business longer!

Number One. We sell more computers at retail than anyone. Radio Shack's 50 million customers are a testament to our dedication to your satisfaction.

Ideal PC for Education, Home and Small Business

(1) Tandy 2500 SX/25. Race through applications with 25MHz speed and an 85MB hard drive! The 2500 SX/25 is an AM386SX™-based system that comes with MS-DOS® 5.0, as well as easy-to-use Microsoft® Windows and Works for Windows software and a mouse. Super VGA graphics give you incredibly vivid displays, and enhanced speech and sound add an extra dimension to computing. SmartDrive™ IDE technology is built in, so adding a hard drive is easy and inexpensive. Three open expansion slots and two open device bays give you plenty of room for options and upgradability.

The Ultimate Computer for Home Management

(2) Tandy 1000 RSX. So easy to use, you'll forget it's a computer. The RSX is our lowest priced computer, but it comes with advanced features you won't find in similarly priced units. An AM386SX™ processor running at 25MHz gives 50% faster performance than a 16MHz CPU. Super VGA graphics and Tandy's Enhanced Sound bring life to business, home or educational programs. Two open 16-bit slots allow for easy expansion. A stereo headphone jack with volume control allows use without disturbing others. Comes with 101-key keyboard, mouse, 1MB RAM, MS-DOS 5.0, and 24 DeskMate programs (pre-installed on the 52MB SmartDrive in the #25-1454 HD system).

F.Y.I.

SUPER VGA. An enhanced display that produces higher resolution graphics than regular VGA monitors.

IDE (INTEGRATED DRIVE ELECTRONICS). Allows use of a hard drive without having to add a controller.

(DAC) DIGITAL ANALOG CONVERTER. Gives your PC amazing speech and music capabilities and lets you record, edit and play back sound effects from a variety of sound sources.

Whether your needs are business or personal—we have the right computer for you

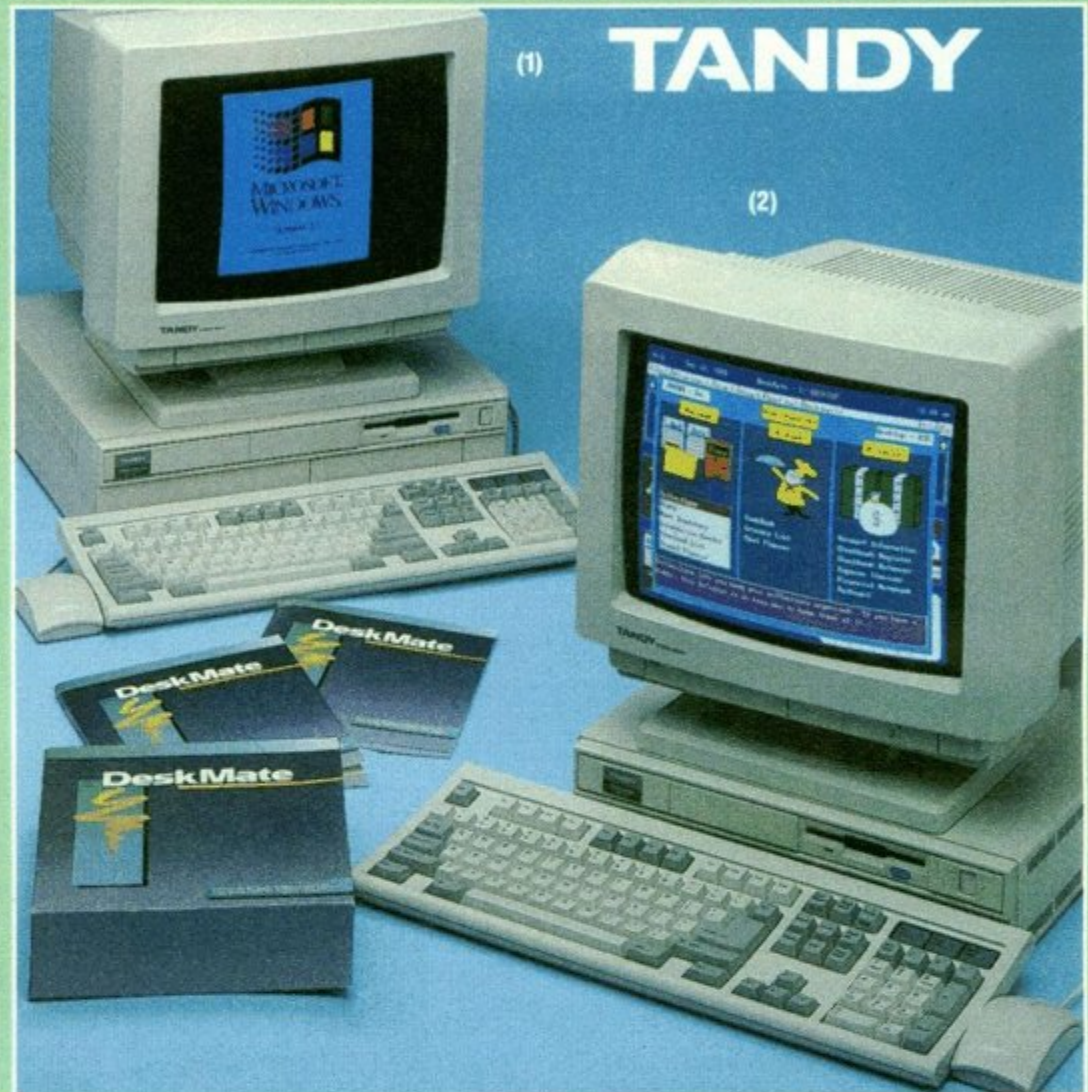

KEY FEATURES	Tandy 1000 RSX	Tandy 2500 SX/25
Microprocessor	25MHz AM386SX™ Optional 80387SX/25 Coprocessor	25MHz AM386SX™ Optional 80387SX/25 Coprocessor
Memory	1MB (9MB Max)	2MB (16MB Max) (4MB in 25-1612)
Storage	3 1/2" 1.44MB Floppy Optional IDE Hard Drive (52MB HD in 25-1454)	3 1/2" 1.44MB Floppy Optional IDE Hard Drive (120MB HD in 25-1612) 85MB HD in 25-1610 One 5 1/4" Device
Display Modes	16-bit Super VGA Graphics with 640 x 400 in 256 colors Optional Modes (requires video RAM upgrade to 512K), standard in 25-1612: 640 x 480 in 256 colors, 800 x 600 in 16 colors, 1024 x 768 in 16 colors	
Built-in Audio	8-bit bi-directional DAC, internal speaker/vol. control	
Bundled Software	MS-DOS 5.0, DeskMate, DeskMate Home Organizer	MS-DOS 5.0, Windows 3.1 HD models also include MS-Works for Windows
Expansion Slots	Two 16-bit AT	Three full 16-bit AT
Built-in Ports	Serial, parallel, mouse, microphone and headphone	
Keyboard	101-key enhanced	101-key enhanced
Power Supply	25 watts	67 watts
Footprint (H x W x D)	27 1/8 x 15 x 14"	4 1/4 x 15 1/2 x 15"
Certification	Class B, UL listed	
Price without monitor	25-1454, \$999.95 (52MB HD) 25-1455, \$799.95 (Floppy Only)	25-1610, \$1299.95 (85MB HD) 25-1611, \$999.95 (Floppy Only) 25-1612, \$1699.95 (120MB HD)

Let us custom-build a Tandy computer system to your own specifications—within 72 hours!



Built in our own factory in the United States, your computer receives all the benefits of Tandy's strong research and development activities, rigid standards of quality and world-class, state-of-the-art manufacturing techniques, thus ensuring your total satisfaction.



Introducing the Tandy "Build-To-Order" Program Customized PCs Straight From the Factory!



Gone are the days when you had to take someone else's concept of what your computer should be. Now, our trained team of computer specialists is available to build your computer to fit your precise needs. Choose your ideal combination of disk drives, mass storage devices, memory configurations and more. We'll even pre-install the operating system of your choice, as well as any of the most popular software titles available—just tell us what you need!

- ONLY PAY FOR WHAT YOU NEED—by selecting only the features you need, you'll save hundreds over what you'd pay for unwanted "bells and whistles" that come with most mass-produced computers
- FUTURE NEEDS WON'T MAKE YOUR COMPUTER OBSOLETE—start with a computer configured for today's needs and budget; you can upgrade at any time as your requirements grow and your budget allows
- COMPATIBILITY ASSURED—our unique ordering process screens your configuration to make sure that you'll have what you need to run your specified applications, and there are no "incompatibilities" in your configuration
- INDIVIDUAL ATTENTION TO YOUR COMPUTER—your custom-built computer is individually tracked from the moment we receive your order till the time it leaves the factory
- FULLY TESTED BEFORE SHIPMENT—your computer system will be extensively tested before it leaves the factory. Just tell us where you want it shipped, and we'll do the rest. When you receive it, you're ready to plug it in and get down to business. Think of it—your own custom PC, built and on its way to you within 72 hours!

Guaranteed 72-Hour Turnaround!

Visit Your Nearest Radio Shack Store for Details and to Place an Order
AVAILABLE OCTOBER 1992

Design your own "Perfect System" in 5 easy steps



1

First, choose the platform that's right for you. Select either the versatile, easy-access "OMNI-Profile" desktop chassis or the Floor-Standing design (shown) for maximum expandability and space conservation.



2

Then, select the Intel® microprocessor that matches your workload and budget. Your choices range from the cost-effective 20MHz 80486SX to the blazingly fast 66MHz 80486DX2 processor.



3

Next, select the system memory (up to 64MB) and video memory options that you require. Add the mass storage devices you need, such as hard drive, tape backup unit, or a CD-ROM drive.



4

Select the appropriate monitor, operating system (MS-DOS or XENIX/UNIX), keyboard and selected applications you need to get the job done right. You're on your way to creating the "perfect system" for you!



5

Let us get your system ready to go. We will fully test your computer to make sure that it meets all of our rigid standards and specifications. Your custom-made computer is ready to go!

Multimedia—a new dimension of sight and sound

Discover a revolutionary computing technology. Interactive, multisensory explorations. CD-quality sound, vivid animation and motion pictures and incredible storage. A dimension of wonder that motivates, stimulates and



captivates. This is the exciting world of multimedia.

Tandy's complete line of Multimedia PCs makes it all possible. Super-VGA graphics. Digital stereo sound. Massive storage capability. Fast data access. Best of all, the Tandy MPCs now available from Radio Shack are the first computers in the industry which are fully-configured according to the Multimedia Personal Computing specifications for compatibility.



Introducing the New Line of Tandy Multimedia Personal Computers

All Tandy MPC systems are 100% PC compatible, so you can use MS-DOS, Windows and multimedia titles. Each features MS-DOS 5.0, Microsoft Windows and Multimedia Extensions, Tandy 16-bit audio adapter, 4MB RAM, 512K video RAM, 101-key keyboard, serial port, parallel port, Super VGA graphics, two-button mouse, and CD-ROM drive. Monitor not included. Made in the USA.

(1) Tandy 4833 LX/T MPC. Our best MPC for developmental applications. Top-of-the-line floor-standing unit features a 33MHz Intel 486 DX processor, 120MB hard drive, two extra 5 1/4" device slots, five open 16-bit ISA expansion slots and 300-watt power supply. (TSP) 25-4023 4499.00

(2) Tandy 4850 EP MPC. Get four times the speed of ordinary 386 PCs with the 50MHz Intel486™DX2™ processor. Includes math coprocessor, 8K cache and 120MB hard drive. (TSP) 25-4024 3499.00

Turn Your "Ordinary" 386-Based or 486-Based PC Compatible Into a Multimedia PC

Multimedia PC Upgrade Kit. Includes CD-ROM drive, audio adapter with MIDI connector, Microsoft Windows, Multimedia Extensions and sample applications. Requires 80386SX processor operating at 10MHz or faster, 4MB RAM, 3 1/2" floppy drive, 85MB hard drive, Super VGA, two-button mouse and MS-DOS 5.0.

Internal Kit. Requires one 5 1/4" device bay and one 16-bit expansion slot. (TSP) 25-1085 799.95

MPC CD-ROM Programs Educate and Entertain

Autodesk Animator from Autodesk. Combines brilliant color graphics, text and photos to produce video animations. 25-4281 199.00

Trax from Passport Designs Inc. Compose, record, edit and playback your arrangement with your PC and MIDI instruments. 25-4276 99.00

Great Cities of the World—Volume I from InterOptica. Explore Los Angeles, New York, London, Paris, Moscow, Bombay, Cairo, Sydney, Tokyo and Rio de Janeiro. 25-4277 79.95

Great Cities of the World—Volume II from InterOptica. Visit Berlin, Buenos Aires, Chicago, Jerusalem, Johannesburg, Rome, San Francisco, Seoul, Singapore and Toronto. 25-4282 79.95

The Sleeping Beauty from EBook. This timeless story comes to life with original illustrations, animation, sound effects and music. 25-4278 49.95

Electronic Library of Art from EBook. Over 1000 full-color images, plus explanatory text and audio, paintings, sculptures, architecture and more. 25-4279 99.95

Guide from Owl International, Inc. A complete authoring tool to create multimedia presentations and applications. 25-1443 495.00

Learn to Speak Spanish from The Hyperglot Software Company. Thirty interactive lessons featuring voices of native speakers. Includes grammar explanations, listening comprehension and writing exercises. 25-4275 99.00

Music Bytes from Prosonus. Performances by world renowned musicians. The ultimate audio tool for multimedia. 25-4280 99.95

EZSOUND FX for Windows from Future Trends. Add sounds to most Windows events, import sounds, and play music in the background when using any Windows or DOS application. 25-4283 ... 69.95



Curtain Call for Windows from Zuma Group. Produce professional presentations and videos with graphics, digital sound and MIDI music. Step-by-step tutorial and manual. 25-4284 149.95

Dictionary for Children from Macmillan. Brings the power of multimedia to America's best-selling children's dictionary. Features almost 12,000 word entries, 1000 illustrations, and 400 sound effects. 25-4290 69.95

Composer's Quest. A sight and sound tour of the greatest composers, their times and their music from 1600 to the present. 25-4291 69.95

Our House from Context Systems. Answers two of the basic questions posed by every child: "How does it work?" and "What was it like when you were young?" 25-4293 69.95

American Vista from Applied Optical Media Corp. Includes maps of the 50 states, over 1000 photographs showing landmarks, geography and culture, and more. 25-4294 69.95

Playing With Language: Spanish from Syracuse Learning Systems, Inc. Learn a new language through games and stories. Choose from different levels of difficulty. 25-4296 69.95

Battle Chess from Interplay Productions. Combines magnificent chess logic with dramatic 3D animations of a medieval world at war. Winner of a Best Graphics Award from the Software Publishers Association. 25-4297 69.95

The Chessmaster 3000 from The Software Toolworks. The best chess program in the world! 25-4298 69.95

CD/DOS Titles

Guinness Disc of Records from Compton's New Media. Contains more than 7000 records and over 300 full-color photographs. 25-1823 79.95

Compton's Family Encyclopedia from Compton's New Media. Includes more than 30,000 articles, 15,000 images, world atlas and Webster's Intermediate Dictionary. 25-1824 395.00

The new Tandy Sensation! Multimedia PC begins where ordinary PCs leave off!



MPC
Multimedia PC

Discover the Total Multimedia Experience!

Tandy Sensation! If you thought you'd never want a PC in your home, you're ready for a new Sensation! You'll experience a new, interactive world of vibrant graphics and animation, true digital stereo sound, instant access to volumes of information and practical, easy-to-use applications. Sensation also comes with a huge library of ready-to-use information on CD-ROM discs! And don't worry about having to learn to run Windows--the included WinMate software makes Windows so easy, the entire family will feel right at home with Sensation. Each family member can actually "customize" WinMate to their liking. That means the kids can go right to the included Encyclopedia or Atlas without ever disturbing your personal finance files. If you work at home, you'll love Sensation! Prepare a report based on your findings in the World Almanac and dress up the text with images from the clip-art library. You can then have Sensation access your client list, dial the correct phone numbers and automatically send your report using Sensation's built-in fax! After hours, relax with your favorite CD-ROM game and experience stereo sound effects, music, animation—and characters that actually talk! Of course, you can run standard PC software as well. Features include a 20MHz 80486SX, 4MB RAM, 107MB hard drive, the exclusive 16-million color Tandy palette chip, send fax/modem, microphone jack, stereo headphone jack, parallel printer port, serial port, MIDI port, dual joystick ports and a two-button mouse. (TSP) **25-1650** **1999.00**

Display TV on Your VGA Monitor

PC/TV Add-In Board. See and hear broadcast (VHF/UHF) and cable TV channels on your PC. Software controls tuning, volume, brightness, contrast, color and hue. Includes coax connector for TV antenna input and phono jack for audio output. Requires 512K RAM, VGA or Super VGA, MS-DOS or Windows 3.X and 8-bit slot. (Special order.) **25-1660** **399.95**



The Tandy Sensation! Comes Complete With A Library of Software

WinMate™—The Organizer for Windows. A collection of 26 multimedia applications that can help you organize your personal, family and business lifestyle. The *Communications Central* includes *Teleminder*, a PC voice mail system that also allows you to get text messages and *Info Central*, a home or office messaging system. *Multimedia Travel Planner* features photos, maps and information about 21 different U.S. cities. *Print Companion* lets you print banners, cards, signs and more, and includes over 400 ClipArt images. *Education and Entertainment* has games that make learning fun or help you relax. *Microsoft Works for Windows Templates* help you keep your checkbook register, balance your checking account, maintain an address book, and inventory your hobby collection. *Much, Much More!* There are also full-color photos for use in Windows, songs and sound effects, three additional type fonts, the complete 800-number directory from AT&T, a 30-day cartoon sampler from Daily Pop and incredible text-to-speech technology you have to hear to believe.

Microsoft Bookshelf for Windows CD-ROM Reference Library. Combines the sights and sounds of multimedia with seven of the most popular reference books. You get *The World Almanac and Book of Facts*, *The Concise Columbia Dictionary of Quotations*, *Roget's II Electronic Thesaurus*, *Bartlett's Familiar Quotations*, *Concise Columbia Encyclopedia*, *The American Heritage Dictionary*, and *Hammond Atlas*. Also features over 1000 images and maps, over 20 animations and 65,000 spoken pronunciations. You can even hear excerpts from famous speeches and national anthems.

Microsoft Works for Windows. This amazing CD-ROM Multimedia Edition combines the most important personal productivity tools, common sense ease of use, and incredible sights and sounds. In fact, animated lessons and much more make learning and using all the Works tools—word processor, spreadsheet, database, charting, drawing and communications—fast and fun.

Online Communications. One of the most enjoyable ways that you can use your computer is to go online with a computer information service. These services maintain huge banks of information, and, after subscribing to the service or services of your choice, you'll be able to access this information with your Tandy Sensation MPC and the included 2400-bps modem. *America Online* uses a graphical interface—with pull-down menus and colorful icons—to give you easy access to a wide range of useful and fun services. *The Prodigy Interactive Personal Service* lets up to six people in your household explore a constantly growing selection of information and helpful services. *CompuServe Information Service* brings you news, weather, sports and much more. And *The Sierra Network* lets you play interactive computer games with another person on the network, whether across town or across the country!

MS-DOS 5.0 Operating System and Windows. Sensation also includes the point-and-click simplicity of Microsoft Windows. It eliminates the intimidation factor many users experience with MS-DOS by simplifying many common tasks. Windows drop-down menus all look and work alike. Learn a few basic concepts, and you'll know how to use any application for Windows. Online help, accessible from anywhere in Windows, provides information at the touch of a button.

COMPLETE INDEX

A

ADAPTERS

- AC to DC 37, 94
- AC Plug 86
- Audio Plug 105, 106
- CD to Cassette 45, 67
- DC Automotive 37, 62, 94
- DC to AC Power Inverter 95
- Foreign AC Power 95
- Mike Stand 77
- RF Plug 112
- Telephone 14, 15
- VCR/Video Plug 102, 103, 112

Adhesives 132

Alarms 56, 71, 80, 81, 84

 Also See Security Equipment

Amateur Radio 28

AMPLIFIERS

- Amplifier/Speaker 45, 48, 75, 120
- Antenna 103
- Home Stereo 43
- PA 72, 75
- Personal Stereo 45, 48
- Telephone 13

ANSWERERS, TELEPHONE 6-7

ANTENNAS

- Amateur Radio 28
- Automotive 67
- CB 27
- Cellular Telephone 17
- Cordless Telephone 5
- FM 98, 99, 104, 105
- Marine 29
- Replacement Rod 27, 104, 117
- Scanner 21
- Shortwave 110
- TV/FM Indoor 104
- TV/FM Outdoor 98, 99
- TV/FM Mobile and Portable 99

ANTENNA ACCESSORIES

- Amplifiers 103
- Cables, Coaxial TV/FM 101, 110
- Connectors and Couplers 101, 102, 103
- Insulators 100, 110
- Masts and Mounts 100
- Rotator and Cable 99
- Splitters 102
- TV Interference Filters 102

AUTOMOTIVE EQUIPMENT

- Alarm Systems 71
- CB Radios 24-25
- Clock 67
- Radar Detectors 70
- Searchlight 93
- Switches 96

AUTO SOUND

- Amplifiers, Boosters and Equalizers 66
- AM/FM Stereo Cassette Players 64, 65
- Antennas 67
- Brackets, Mounting 96
- Cassette Adapter 67
- Cassette Players 64, 65
- CD Players 64, 65
- FM Signal Booster 67
- Installation Kits 67
- Noise Suppressors 96
- Speakers 68, 69
- Speaker Fader 69

B

- Baseball Encyclopedia 142

BATTERIES 88-92

- Camcorder 54
- Cellular Telephone 17
- Chargers 89
- Holders 117
- Tester 126
- Bibles, Electronic 142
- Binding Posts 115
- Biofeedback Monitor 139
- Blood Pressure/Pulse Monitor 139

BOOKS 23, 28, 97

- Bulbs 116
- Breadboards, Experimenter 120
- Buzzers 119

C

(CMC) SPECIAL-ORDER 125

- Cable See Wire and Cable

CALCULATORS 145-149

- Caller ID Devices 10, 12

CAMCORDERS AND ACCESSORIES 54

- Capacitors 119
- Cartridges, Phono 63

CASES

- Camcorder 54
- Cordless Phone 5
- Personal Stereo 61, 63
- Project 124
- Tape Storage 60, 61
- Cassette Equipment See Tape Equipment
- Cassette Tapes See Tape

CB Equipment, See Citizens Band Equipment

CD PLAYERS AND ACCESSORIES

- Home 40, 41, 44
- Car 64, 65
- Portable 45

CELLULAR TELEPHONES AND ACCESSORIES 16-17

- Chargers, Battery 89

CHEMICALS 131

CHESS GAMES 133

CITIZENS BAND EQUIPMENT AND ACCESSORIES 24-25, 27

CLEANERS

- Audio 62, 63
- Computer 156
- CD 63
- Sprays 131
- Vacuum 128
- VCR Head 60

CLIPS

- Alligator and Battery 115
- Microphone 26

CLOCKS 67, 141

CLOCK RADIOS 31, 32

COMPUTER EQUIPMENT

- Tandy® Multimedia PCs 168-169
- Tandy Notebook PCs 150-151
- Tandy PCs 166-169
- Accessories 151, 156, 157, 165
- DeskMate 153
- Diskettes 156
- Disk Drives 164
- CD-ROM Drive 164
- Hard Drives 164
- Joysticks 156
- Memory Expansion 164
- Mice 156
- Modems 159
- Monitors 165
- Networks 155
- Printers 160-161, 163
- Software 152-153, 154, 155, 159
- Uninterruptible Power System 158

CONNECTORS

- Antenna 21, 101, 102, 112
- Audio 50, 51, 105, 106, 107, 109
- Automotive/Auto Sound 67, 70, 96
- Computer 121
- DC Power 96, 111
- Power 56, 111
- RF/Video 112
- Solderless 111, 112, 121, 132
- Telephone 14, 15, 132
- VCR 103
- Wire 111, 132

CONVERTERS

- Cable-TV 58
- Foreign AC Power 95
- Power 37, 94, 95

COPIER AND ACCESSORIES 143

CORDS

- Microphone 105
- Replacement AC 95, 101, 121
- Telephone 14

 Also See Extension Cords

- Crimpers, Strippers 15, 112, 121

CRYSTALS

- CB Radio 24, 125
- Scanner and Special-Order 125

D

DATA ORGANIZERS 148, 149

- Demagnetizers, Tape Head 62
- Dialers, Telephone 12
- Dimmers, Light 86, 87
- Diodes 123

E

- Earphones 50, 51
- Encyclopedia, Electronic 142

EQUALIZERS

- Auto Sound 66
- Home Stereo 43

EXTENSION CORDS

- AC 87
- Car Antenna 67
- Computer 95, 121
- Headphone 50, 51
- Telephone 14

F

FAX MACHINES & ACCESSORIES 144

- Fans 115

FILTERS

- AC Line Noise 112
- Car Ignition Noise 96
- EMI/RFI Choke Cores 114
- TV Interference 102

Flashlights/Lanterns 93

FUSES AND HOLDERS 96, 117

G

GAMES See Toys and Games

H

HARDWARE 132

HEADPHONES 21, 50, 51

- Adapters 50, 51, 106
- Extensions 50, 51

HEADPHONES (Continued)

- Wireless 51

HEALTH CARE 139

HOME AUTOMATION 82-86

Hygrometer 127

I

- Integrated Circuits 122, 123, 125

INTERCOMS 18

J

JACKS

- Audio 107
- Telephone 14, 15

JOYSTICKS

- Computer 156
- Video Game 134

K

- Karaoke System 33

KEYBOARDS, MUSICAL 138

- Piano Teaching System 138, 154

KITS 136

- Knobs 96, 118

L

- Labels 60, 62, 162
- Labeling System 143
- Lamp Assemblies and Bulbs 116
- Lamp, Table 143
- LANGUAGE TRANSLATORS 142
- LASER DISC/CD PLAYER 53
- LEDs 124

LIGHT

- Controllers 82-86, 138, 140
- Displays 138
- Lubricants 131

M

- Magnets 132
- Magnifiers 129
- Marine VHF Radios 29
- MEGACABLE Speaker Cable 111
- METAL DETECTORS 137
- METERS See Test Equipment
- MICROPHONE

 - Adapters 77
 - Camcorder 54
 - CB/Communication 26, 28
 - Elements 114
 - Recording/PA 76
 - Stands and Accessories 77
 - Wireless 77
 - Microscope 129

- Mixers, Audio 75
- Monitors See Computer Equipment, also Video
- Motors, Hobby 115
- MULTITESTERS 126-127
- MULTIMEDIA COMPUTING 168-169
- Music Systems, Home 40, 41

N

- Noise Filters See Filters

O

- Optoelectronics 124

P

PA EQUIPMENT

- Amplifiers 72
- Microphones and Accessories, 76-77
- Mixers 75
- Speakers 74
- Systems 73

PAGERS 17

PATCH CORDS

- Audio 105
- Video 103
- Pedometers 139
- Pencil Sharpeners, Cordless 143
- Phono Accessories 63
- Photocells 114

PLUG 'n POWER® PRODUCTS 82-86

PLUGS

- AC 86
- Adapters 51, 86, 102, 105, 106
- Audio 107
- Auto Sound 67, 96
- RF/Coaxial Cable 112
- Telephone 14, 15

POLICE/FIRE RADIOS

- Kit 136
- Scanners 19-20, 22-23

POWER ADAPTERS AND CONVERTERS See Adapters

- Power Strips 87, 158
- Power Supplies 94, 95
- Uninterruptible 158

R

RADAR DETECTORS, ACCESSORIES, 70

RADIOS

- Amateur 28

RADIOS (Continued)

- Aviation 31
- Business Band 29
- Children's and Novelty 33
- Citizens Band 24-25
- Clock 31, 32
- Headset 33, 34
- Kits 136
- Marine VHF Band 29
- Multiband 31
- Nostalgia and Table 33
- Portable 30, 31, 33, 34
- Portable Stereo 34, 38, 39
- Portable Stereo Cassette, 35, 38, 39
- Scanner 19-20, 22-23
- Shortwave 30, 31
- TV/Radio Combo 55
- TV Sound 31, 34
- Weatheradio® Receivers 33

RADIO CONTROLLED TOYS 135

RECEIVERS

- Multiband 31
- Satellite TV 56
- Scanner 19-20, 22-23
- Shortwave 30, 31
- Stereo 42
- Weather 33
- Record Accessories 63
- Rectifiers 114, 123
- Recorders See Tape Equipment
- Relays 96, 114

REMOTE CONTROLS 57

- Home Automation 82-86
- Resistors 118
- Reverb Control 75

S

SATELLITE TV SYSTEM AND ACCESSORIES 56

SCANNERS AND ACCESSORIES, 19-23

- Screws 132
- Screwdrivers 128, 129

SECURITY EQUIPMENT

- Home 78, 79, 80, 81, 84
- Mobile 71
- Video Surveillance System 79

 Also See Alarms and Smoke Alarm

- Semiconductors 114, 122, 123, 125

SHORTWAVE RADIOS 30, 31

- Kit 136
- Signboard, Electronic 143

SMOKE ALARM 79

- Alarm System Smoke Sensor 81
- Solar Cell 120

SOLDERING EQUIPMENT 130, 131

- Sound Level Meter 75

SPEAKERS AND ACCESSORIES

- Amplified 21, 48, 75
- Auto Sound 68, 69
- CB/Scanner 21
- Controls 69, 109
- Crossovers 108
- Extension 21, 49
- Grilles 69, 108
- Mounting Brackets 96, 108
- Outdoor and PA 74
- Replacement 69, 108, 109
- Stands 49
- Subwoofer 49
- Switches 109
- Wire 109, 110, 111

SPEAKER SYSTEMS, HOME STEREO 47-49

SPECIAL-ORDER INFORMATION 125

SPELLING CHECKERS 142

SPIKE PROTECTORS 86, 87

STEREO COMPONENTS, HOME 42-44, 46-49

STEREO MUSIC SYSTEMS, HOME 40, 41

- Strobe Light 138
- Stud Finder 129
- Styl, Phono 63
- Surround Sound Decoder 59

SWITCHES

- AC 86, 113
- Audio Component 46
- Automotive/Auto Sound 68, 96
- Foot 62
- Illuminated 113
- Pushbutton and Slide 113
- Stereo Speaker 109
- Toggle 113
- TV/Game 101, 102
- Video Component 57, 59
- Wireless Remote 57, 87
- SWR Meters 26, 28

T

TAPE

- Accessories 60, 61, 62
- Adhesive 132
- Audio Recording 61
- Coax Sealant 110
- Electrical 132
- Storage Cases 60, 61

TAPE (continued)

- Telephone Answerer 13
- Video Recording 60

TAPE EQUIPMENT

- AM/FM Stereo Home Music Systems 40, 41
- Car Cassette Players 64, 65
- Cassette 35, 36, 37, 38, 39, 40, 41
- Children's 33
- Clock Radio 32
- Microcassette Recorders 37
- Playback Decks 46
- Portable AM/FM Stereo Cassette Systems 35, 38, 39
- Portables 35, 36, 37, 38, 39
- Record/Play Home Decks 46
- Tape Control Center 46

TELEPHONES 8-11

- Accessories 12, 13, 14, 15
- Adapters 13, 14, 15
- Amplifiers 13
- Cellular 16
- Clock Radio Combo 32
- Cordless 3-5
- Dialers 12
- Headset 13, 15
- Line Testers 15, 126
- Plugs, Jacks, Cords 14, 15
- Signaling Devices 14
- Systems 11
- Wire 14, 110

TELEPHONE ANSWERS 6-7

TELEVISION See TV

Terminal Boards, Strips 111

TEST EQUIPMENT

- AC Line 87, 95, 126
- Battery 92, 126
- Circuit 95
- DC Automotive 96
- Kit 136
- Leads and Probes 126
- Telephone 15, 126
- Thermometer 139
- TIMERS 140

TOOLS

- Crimpers, Strippers, 15, 112, 121, 129
- Forceps, Pliers 128, 129, 130
- IC 123
- Screwdrivers, Nutdrivers 128, 129
- Soldering 130, 131
- Torches, Gas 131

TOYS AND GAMES

- Educational 136
- Chess and Handheld 133
- Project Kits 136
- Radio-Controlled 135
- Video Game Joysticks 134
- Transformers 114, 115
- Transistors 122, 125
- Tuner, AM/FM Stereo 43

TURNTABLES 43

TV ANTENNAS AND ACCESSORIES 98, 99, 104

TV SETS AND MONITORS 55

- TV/VCR Combos 53

V

- Vacuum Cleaner 128

VCRs 52, 53

- Accessories 57-59
- Multiplying System 58

VIDEO

- Cables 103
- Cable-TV Converter 58
- Camcorders 54
- Laser Disc/CD Player 53
- Monitors 55
- Processors 57, 59
- Recording Tape 60
- Remote Controls 57
- Selectors 59
- Surveillance System 79
- Tape Players 53
- VCR Head Cleaners 60
- Video Game Accessories 134
- Voltage Spike Protectors 86, 87, 158

W

- WALKIE-TALKIES 24-26, 137
- WATCHES 140
- WEATHERADIO® RECEIVERS 33

WIRE AND CABLE

- Alarm System 81, 110
- Antenna 101, 110
- Antenna Rotator 99
- Audio 105, 110
- Coaxial 27, 110
- Computer 121
- Hookup 110
- Intercom 110
- Microphone 110
- Ribbon 121
- Speaker 109, 110, 111
- Telephone 14, 110
- Video 103
- Wire Management 111
- Wire Wrapping 122
- Wire Cutters and Strippers, 128, 129

Buy in Quantity and Save! Get Up to 40% Off!

Quantity buyers and purchasing agents can get big discounts on the 1993 Catalog "each" prices. Save on thousands of items—for premiums, promotions, educational and institutional needs. Call or visit your nearest Radio Shack to order. Terms: NET 30 days, FOB Radio Shack store or warehouse nearest you. Discounts to be taken off single prices. Items may not be assorted.

Equipment	3-5	6-11	12-49	50-499	500-Up
Antennas, TV/FM	...	10%	15%	20%	25%
Audio Components (Receivers, Amps, Tuners, Turntables, Speakers, Headphones, Equalizers, CD Players)	...	10%	15%	20%	25%
Audio Accessories and Parts	15%	25%	33%
Auto Tape Players, Radios, Accessories	...	10%	15%	20%	25%
Batteries (Radio Shack Brands)	10%	20%	30%
Batteries (RS Super Alkaline AA, AAA, C, D, N, 9V, Same Cat. No. Only)	10%	10%	10%	20%	30%
Batteries (Other Brands)	...	5%	7%	10%	20%
Books	...	10%	20%	25%	33%
Calculators, Spell Checkers, Data Organizers	...	5%	10%	15%	20%
CB (Base, Mobile, Walkie-Talkies)	...	10%	15%	20%	25%
CB Antennas, Accessories	10%	15%	20%
Cable and Wire (Bulk Pack Only)	200-499 Ft. at 15% Off per Foot 500 Ft. & Up at 20% Off per Foot				
Computers	...	5%	10%	(See Store Mgr.)	20%
Computer Printers, Peripherals	...	5%	10%	15%	20%
Computer Software	...	7%	12%	17%	20%
Computer Accessories, Supplies	...	10%	15%	20%	25%
Electronic Components, Packaged Wire & Cable	10%	25%	33%
Electronic Games, Space Patrol Walkie-Talkies	...	5%	10%	12%	20%
Fax Machines/Copier	...	5%	7%	10%	15%
Fax/Copier Supplies, Accessories	...	10%	15%	20%	25%
Intercoms	...	10%	15%	20%	25%
Kits (Science Fair and AcherKit)	...	5%	10%	15%	20%
Marine/Ham Transceivers	...	10%	15%	20%	25%
Microphones	...	10%	15%	20%	25%
Music Systems (Portables, Rack, Compacts)	...	5%	10%	15%	20%
PA Equipment	...	10%	15%	20%	25%
Radar Detectors	...	10%	15%	20%	25%
Radios (Clock, Portable, Stereo, Novelty)	...	7%	12%	17%	20%
Radio-Controlled Toys	...	5%	10%	12%	20%
Scanners, Communications Receivers	...	10%	15%	20%	25%
Security Devices	...	7%	12%	20%	25%
Speakers (Unmounted)	...	10%	15%	20%	25%
Tape Recorders and Players	...	10%	12%	17%	20%
Tape, SUPERTAPE Audio Recording Cassettes (Same Cat. No. Only)	10%	10%	20%	30%	40%
Tape, Video Recording Cassettes Only	(No Discount)				
Tape Accessories	10%	20%	25%
Telephones (Also Dialers, Answerers, Amps, Controllers)	...	7%	12%	17%	25%
Telephone Accessories (279-Series)	10%	25%	33%
Telephones, Cellular, Pagers	5%	10%	15%
Televisions, VCRs, Camcorders, Satellite System	...	5%	7%	10%	15%
TV/Video Accessories	10%	20%	25%
Test Equipment, Power Supplies	...	10%	15%	20%	25%
Timers, Electrical Accessories, Plug 'n Power, Flashlights, Clocks, Watches, Metal Detectors, Health, Home Products	...	5%	7%	10%	20%
Tools, Solder, Hardware, Chemicals	...	5%	7%	10%	20%
Wordprocessors	...	5%	10%	15%	20%

Radio Shack ValuePlus® Credit



No Annual Fee To Pay

Our ValuePlus consumer revolving credit program gives you your own personal line of credit at Radio Shack. Budget your purchases with monthly payments or pay your balance in full at any time and avoid finance charges for the current billing cycle. Actual payments may vary depending upon account balance. Details are available at Radio Shack stores or participating Radio Shack Authorized Dealers. Come in and apply today.

Most Locations Also Welcome These Cards



Commitment to Education



Since 1979, our Education Division has supported Tandy/Radio Shack computers in the classroom. Our SchoolMate® network solution links PC compatibles throughout a classroom, department or school, and comes with built-in productivity tools for the teacher. We also offer the best curriculum solutions for your school—all from today's leading educational publishers.

Employment Opportunities

Promising Careers in Retail Sales and Sales Management



If you have sales ability, are willing to work to achieve maximum results and are interested in compensation keyed to productivity, then our Radio Shack store training programs may be the career opportunities you've been looking for. Thanks to our continuing growth, there are career opportunities available in many market areas. Write Our National Headquarters for the District Sales Office location nearest you.

RETAIL EMPLOYMENT
Dept. 472

500 One Tandy Center, Fort Worth, TX 76102
An Equal Opportunity/Affirmative Action Employer

Tandy Service Plans Available at Radio Shack Stores Nationwide

TSP

Radio Shack's commitment to SERVICE includes affordable buyer protection. TSPs are available for many of our products. Convenient and easy to start, these Plans take the worry out of maintaining your equipment and extend parts and labor coverage to a total of five years in many cases. Initial coverage is inclusive of normal product warranty. Service is performed by expert technicians in Company-owned Service Centers and is available through our nearly 7000 retail locations nationwide. With a Tandy Service Plan, you won't experience any unexpected repair costs.

Look for "(TSP)" preceding catalog number in product descriptions as in example below.

Tone controls and slide-action balance control with center detent. (TSP) 12-1985 69.95

Series	Description	Price	Years
12	Sound Items below \$50	14.95	3
12	Sound Items below \$100	24.95	3
12	Sound Items above \$100	34.95	3
13	Systems below \$500	49.95	3
13	Systems above \$500	99.95	5
14	Decks below \$100	39.95	5
14	Decks above \$100	59.95	5
14	Cassettes below \$50	19.95	3
14	Cassettes below \$100	29.95	3
14	Cassettes above \$100	39.95	3
15	Video Items below \$100	19.95	3
15	Video Items above \$100	29.95	3
16	Video Cassette Players and VCR/TV combos	79.95	3
16	VCRs, CD/D Players & VCR/TV Combos	139.95	3
16	VCRs	49.95	1
16	Televisions, Pocket	49.95	3

Series	Description	Price	Years
16	Televisions, Black & White	29.95	3
16	Televisions, Color	79.95	3
16	Camcorders	79.95	1
16	Camcorders	199.95	3
17	Cellular Phones (mobile only)	99.95	3
17	Cellular Phones (all others)	129.95	3
19	Transceivers	39.95	5
20	Scanners below \$200	39.95	5
20	Scanners above \$200	59.95	5
21	Communications below \$50	19.95	3
21	Communications above \$50	39.95	3
22	Radar Detectors	39.95	3
22	Multitesters	9.95	3
31	STA/SCR Receivers	59.95	5
31	Equalizers	39.95	5
32	PA Items below \$50	19.95	5
32	PA Items above \$50	39.95	5
33	Headphones/Mikes below \$50	19.95	3

Series	Description	Price	Years
33	Headphones/Mikes above \$50	29.95	3
42	Musical Keyboards	29.95	5
42	LAB Turntables	29.95	5
42	Components below \$50	19.95	5
42	CD Players	59.95	5
43	TAD Answering Devices	39.95	3
43	Phones/Intercoms below \$50	10.95	3
43	Phones/Intercoms below \$100	24.95	3
43	Phones above \$100	34.95	3
43	FAX Machines	149.95	3
48	Alarm Control Units	29.95	3
61	Security Items below \$50	19.95	3
61	Security Items above \$50	29.95	3
63	Personal Copier PPC-750	149.95	3
63	Electronic Items below \$50	14.95	3
63	Electronic Items below \$100	24.95	3
63	Electronic Items above \$100	34.95	3
65	Calculators below \$50	9.95	3
65	Calculators above \$50	19.95	3

Price breaks are based on CURRENT ANNUAL CATALOG price. Sale prices do not apply. Carry-in and On-Site TSPs are available for Tandy computer equipment. For details, visit your local Radio Shack.

THE TECHNOLOGY LEADER FOR OVER 70 YEARS



NOBODY COMPARES... Now more than ever, Radio Shack is the smart place to shop for the best in electronics. Discover an unsurpassed selection of quality products, the latest in technology, plus fast, personal service at nearly 7000 locations nationwide. It's no wonder each year 50 million Americans shop America's Technology StoreSM.



NEW!

Memorex™ Portable 5" Color TV with built-in 8mm VCR
Page 53



NEW!

Optimus® Mini Stereo System
with 4-Disc CD Carousel Page 41



NEW!

DUoFONE® Voice-Scrambling
Cordless Phone Page 3

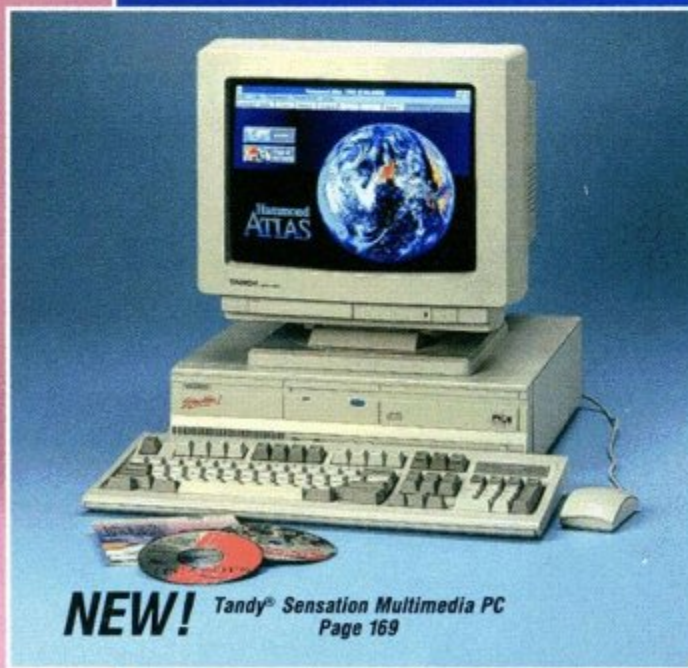

NEW!

Tandy® Sensation Multimedia PC
Page 169

Radio Shack
AMERICA'S
TECHNOLOGY
STORESM

1993 CATALOG